



**Leptin regulation of inflammatory responses in
human gingival fibroblasts**

Rachel Claire Williams MRes BSc (Hons)

**A thesis submitted in partial fulfilment of the requirements for the
degree of Doctor of Philosophy**

**Institute of Cellular Medicine and Centre for Oral Health Research,
Newcastle University, UK**

February 2015

Abstract

Obesity and type 2 diabetes mellitus (T2DM) are positively associated with the destructive, chronic inflammatory disease periodontitis. The adipokine leptin is elevated in obesity and T2DM, and promotes inflammatory responses. Gingival fibroblasts are implicated in the pathogenesis of periodontitis because inflammatory stimuli can drive these cells towards destructive, inflammatory responses. The aim of this study was to identify whether leptin promotes inflammatory responses in gingival fibroblasts, focussing on the extracellular matrix-degrading matrix metalloproteinases (MMPs), and their inhibitors (TIMPs).

Primary human gingival fibroblasts (hGFs) were isolated from gingival tissue and cultured *in vitro*. RT-PCR, ELISA and flow cytometry were used to assess MMP, TIMP and TLR expression; hGF signalling (\pm chemical pathway inhibitors) was assessed by Western blotting.

hGFs constitutively expressed numerous MMPs and TIMPs. Leptin increased the expression of MMP-1, MMP-3, MMP-8 and MMP-14, but not TIMPs, in hGFs. Leptin and interleukin-1 or the TLR2 agonist pam2CSK4 synergistically increased MMP-1 and MMP-3 production by hGFs; in contrast, leptin and *Escherichia coli* LPS regulated MMP production in a donor-dependent manner. TLR4 was detected on the surface of hGFs from all donors tested, suggesting that differential responses to *E. coli* LPS were not due to absent cell surface TLR4. Overall, these results suggest that leptin promotes an ECM-degrading hGF response, which is further enhanced under inflammatory conditions. Leptin activated multiple intracellular signalling pathways, but the MAPK pathway and ERK in particular, regulated leptin-stimulated MMP-1 expression in hGFs. Genome-wide expression profiling revealed that leptin enhanced the expression of genes in hGFs whose products function in inflammation; similarly, leptin enhanced the inflammatory gene expression profile induced by IL-1 in hGFs. Leptin+interleukin-1 did not promote collagen degradation in human gingival connective tissue explants.

In conclusion, leptin enhances wide-ranging inflammatory responses in hGFs in a context-dependent manner. This response could be a mechanistic link between obesity, T2DM and periodontitis.

Acknowledgements

I would like to express my sincere gratitude to my PhD supervisors Dr John Taylor, Prof Philip Preshaw and Prof Drew Rowan for their expert advice and encouragement throughout every aspect of this PhD. John, the discussions we've had, the opportunities you have supported, the freedom you gave me, and the laughs we've shared have helped me become the scientist I am today. Thank you.

I would like to acknowledge and thank the clinical team Dr John Meechan, Ms Helen Moore and Ms Jayne Fahey for the provision of gingival tissue samples. I must acknowledge that the MMP activity assay used in this study was based on a protocol developed by my colleagues in the Musculoskeletal Research Group at Newcastle University, and thank Dr Katrin Jaedicke for her assistance with this assay. I am also extremely grateful to Prof Stephen Todryk at Northumbria University for his expert advice and acquisition of the flow cytometry data presented in this thesis. I would like to thank Mr Andrew Skelton who performed much of the challenging bioinformatics analysis on the microarray datasets. I must also acknowledge, and thank, Mr Rawa Ahmed who performed the IL-24 ELISA, and Dr Stephen Hill who performed the precision cut slicing. I am extremely grateful to the Medical Research Council, the Institute of Cellular Medicine and the Centre for Oral Health Research at Newcastle University, and the Oral and Dental Research Trust who funded this studentship.

I wish to thank all my colleagues and friends in the Translational Oral Biosciences lab and Musculoskeletal Research Group for their advice and support. Special thanks go to Mrs Lesley Old, Dr Katrin Jaedicke, Dr Jonathan Baker, Dr David Wilkinson, Dr Chris Macdonald and Mr Mark Vernon whose tolerance in addressing my frequent questions I am truly grateful for.

I am very lucky to have two inspirational scientists that I can call mum and dad. Thank you for everything, and most recently for your critical thoughts on this thesis. I am also sincerely grateful to Gareth, GG and GG's girls for keeping me in touch with the real world, and the VDMs for your delightful hospitality. Finally, thank you Graeme for your unfaltering love, words of encouragement, emotional support and saintly perseverance. I am so glad that we took on this adventure together.

Table of Contents

Abstract.....	i
Acknowledgements.....	ii
List of figures.....	xi
List of tables.....	xv
List of abbreviations.....	xvii
1 Chapter 1. Introduction	1
1.1 Biological importance of leptin.....	1
1.2 Intracellular signalling pathways stimulated by leptin.....	2
1.2.1 Structural features of leptin and the leptin receptor.....	2
1.2.2 Leptin signalling pathway activation.....	3
1.2.3 Regulation of the leptin signalling pathway.....	5
1.3 Obesity, diabetes and leptin resistance.....	6
1.4 Leptin as a regulator of immunity, inflammation and wound healing.....	8
1.4.1 Leptin and leukocyte recruitment.....	9
1.4.2 Leptin regulation of leukocyte function.....	9
1.4.3 Leptin regulation of ECM remodelling.....	10
1.4.4 Leptin regulation of the vasculature and fibrosis.....	12
1.4.5 In vivo studies of immunological functions of leptin.....	12
1.5 The periodontium: structure and function.....	13
1.5.1 Alveolar bone and the periodontal ligament.....	14
1.5.2 Gingival tissue.....	14
1.5.3 Gingival crevicular fluid.....	15
1.5.4 Host-microbe interactions in the periodontium.....	16
1.6 Periodontitis.....	17
1.6.1 Clinical aspects of periodontitis.....	18
1.6.2 The pathogenesis of periodontitis.....	19

1.7	Association of obesity and T2DM with periodontitis	21
1.7.1	T2DM and periodontitis	21
1.7.2	Obesity and periodontitis	21
1.8	Association of leptin with periodontitis	23
1.8.1	Clinical associations between leptin and periodontitis	24
1.8.2	Leptin in the periodontium.....	25
1.9	The role of MMPs in periodontitis	26
1.9.1	MMP structure and function	26
1.9.2	MMPs are associated with periodontitis	28
1.9.3	MMPs in the pathogenesis of periodontitis.....	29
1.10	Mechanisms of MMP regulation during inflammation	30
1.10.1	Stimuli that regulate MMP expression.....	30
1.10.2	Intracellular signalling pathways and transcription factors regulate MMP expression.....	31
1.10.3	Regulated secretion of MMPs.....	32
1.10.4	Activation of pro-MMPs	32
1.10.5	Inhibitors of MMPs	33
1.11	The role of gingival fibroblasts in inflammation and immunity.....	34
1.11.1	Regulation of ECM remodelling.....	35
1.11.2	Innate recognition of microbes	37
1.11.3	Regulation of leukocyte recruitment.....	37
1.11.4	Regulation of inflammation and immune responses.....	38
1.11.5	Gingival fibroblasts as a unique cell type	40
1.11.6	Gingival fibroblasts and leptin.....	41
1.12	Aims.....	43
2	Chapter 2. Methods	50
2.1	Materials	50
2.1.1	Recombinant proteins.....	50

2.2	Tissue culture techniques	51
2.2.1	Primary hGF isolation	51
2.2.2	Primary hGF subculture	52
2.2.3	hGF characterisation	52
2.2.4	Cell counting and viability assessment by haemocytometer.....	53
2.2.5	Cryopreservation and recovery of hGFs	53
2.2.6	In vitro stimulation of hGFs	53
2.2.6.1	Chemical pathway inhibitors	54
2.2.7	Preparation of hGFs for flow cytometry	55
2.2.8	Staining gingival tissue for triglycerides.....	56
2.2.9	Gingival tissue stimulation.....	56
2.2.9.1	Papain-mediated digestion of gingival tissue	56
2.3	Immunocytochemistry	57
2.4	Histological processing of gingival tissue.....	57
2.4.1	Precision slicing of gingival tissue.....	58
2.4.2	H+E staining of gingival tissue sections	58
2.5	Colourimetric cell proliferation assays.....	58
2.5.1	Tetrazolium compound method	58
2.5.2	Lactate dehydrogenase assay	59
2.6	DNA and RNA extraction techniques	60
2.6.1	Total RNA purification	60
2.6.2	Nucleic acid stabilisation	60
2.7	RT-PCR.....	60
2.7.1	Reverse transcription reaction.....	60
2.7.2	Conventional RT-PCR	61
2.7.3	Real-time RT-PCR.....	61
2.8	Microarray analysis	62
2.8.1	TaqMan Low Density Array	62

2.8.2	Genome-wide expression microarray	63
2.9	ELISA.....	65
2.10	Flow cytometry	66
2.11	SDS-PAGE and immunoblotting.....	67
2.11.1	Cell preparation for SDS-PAGE	67
2.11.2	Bradford assay.....	67
2.11.3	SDS-PAGE and immunoblotting	68
2.12	GAG assay	69
2.12.1	GAG assay procedure	69
2.13	Hydroxyproline assay	70
2.13.1	Acid hydrolysis of gingival tissue digests and supernatants.....	70
2.13.2	Hydroxyproline assay.....	70
2.14	MMP activity assay	71
2.15	Statistical analysis.....	72
3	Chapter 3. Regulation of MMP and TIMP production by gingival fibroblasts stimulated with leptin.....	88
3.1	Introduction	88
3.2	Basal expression of MMPs and TIMPs in gingival fibroblasts.....	91
3.3	Regulation of MMPs and TIMPs in gingival fibroblasts by leptin	91
3.3.1	MMP-1	92
3.3.2	Other collagenases	93
3.3.3	Gelatinases	93
3.3.4	Stromelysins.....	93
3.3.5	Other MMPs.....	94
3.3.6	TIMPs.....	94
3.3.7	MMP activity	95
3.4	Proliferative response of gingival fibroblasts to leptin stimulation	95
3.5	Discussion	96

4	Chapter 4. Synergistic regulation of MMP and TIMP production in gingival fibroblasts by leptin and pro-inflammatory mediators.....	116
4.1	Introduction	116
4.2	MMP and TIMP production by gingival fibroblasts in response to stimulation with leptin and pro-inflammatory cytokines	118
4.2.1	Synergistic regulation of MMP-1 production by gingival fibroblasts after stimulation with leptin, IL-1 and OSM	119
4.2.2	Synergistic regulation of MMP-3 production by gingival fibroblasts after stimulation with leptin, IL-1 and OSM	119
4.2.3	Effect of leptin, IL-1 and OSM on the expression of other MMPs and TIMPs in gingival fibroblasts	120
4.3	MMP and TIMP production by gingival fibroblasts after stimulation with leptin and TLR agonists	121
4.3.1	Leptin and pam2CSK4 synergistically regulate MMP production by gingival fibroblasts.....	122
4.3.1.1	MMP-1.....	122
4.3.1.2	MMP-3.....	122
4.3.1.3	MMP-14.....	123
4.3.1.4	TIMP-1.....	123
4.3.1.5	TLR2 surface expression	123
4.3.2	Synergistic regulation of MMP and TIMP production by gingival fibroblasts after stimulation with leptin and E. coli LPS	123
4.3.2.1	MMP-1.....	123
4.3.2.2	MMP-3.....	124
4.3.2.3	MMP-14 and TIMP-1	124
4.3.2.4	TLR4 surface expression	124
4.4	Discussion	124
5	Chapter 5. Investigation of intracellular signalling pathways which regulate MMP-1 expression in leptin-stimulated hGFs.....	154
5.1	Introduction	154

5.2	Leptin receptor expression by gingival fibroblasts	156
5.3	Activation of intracellular signalling pathways in gingival fibroblasts stimulated with leptin, IL-1, OSM and pam2CSK4.....	157
5.3.1	Leptin activation of the MAPK signalling pathway in hGFs.....	157
5.3.2	Leptin activation of the JAK/STAT signalling pathway in hGFs.....	158
5.3.3	Leptin activation of the PI3K signalling pathway.....	159
5.3.4	Leptin activation of the NF- κ B signalling pathway.....	159
5.4	Signalling pathway intermediates which regulate MMP-1 expression in leptin-stimulated gingival fibroblasts	160
5.4.1	MEK/ERK regulate leptin-stimulated MMP-1 gene expression in hGFs 160	
5.4.2	JNK regulation of MMP-1 gene expression in hGFs.....	161
5.4.3	p38 regulation of MMP-1 gene expression in hGFs	161
5.4.4	STAT3 regulation of MMP-1 gene expression in hGFs	161
5.4.5	AKT regulation of MMP-1 gene expression in hGFs.....	161
5.5	Discussion	161
6	Genome-wide expression profiling of gingival fibroblasts after stimulation with leptin and IL-1	182
6.1	Introduction	182
6.2	Expression of immune function genes in leptin-stimulated hGFs – pilot study 184	
6.2.1	Gene expression analysis by TLDA.....	184
6.2.1.1	Chemokines and CSFs.....	184
6.2.1.2	Cell surface markers	185
6.2.1.3	Intracellular signalling molecules.....	185
6.2.1.4	Immune and inflammatory mediators.....	185
6.2.1.5	Other genes	185
6.2.2	Leptin-stimulated hGFs increase IL-6 secretion	186
6.3	Genome-wide expression analysis in hGFs stimulated with leptin and IL-1 .	186

6.3.1	IL-1 α and IL-1 β similarly regulate MMP-1 expression in hGFs.....	186
6.3.2	Generation of successful stimulations and high quality RNA	187
6.3.3	Overview of genome-wide expression results	188
6.3.4	Differentially expressed genes in hGFs stimulated with leptin	188
6.3.5	Differentially expressed genes in hGFs stimulated with IL-1	189
6.3.6	Differentially expressed genes in hGFs stimulated with leptin+IL-1	190
6.3.7	Genes synergistically regulated by leptin+IL-1 in hGFs	190
6.3.8	Further analysis of selected genes by real-time RT-PCR	191
6.3.9	IL-24 secretion by hGFs stimulated with leptin and IL-1	192
6.4	Discussion	193
7	Chapter 7. Development of an explant model to assess leptin+IL-1-mediated gingival tissue collagen degradation	231
7.1	Introduction	231
7.2	Development of a gingival tissue explant model	234
7.2.1	Characterisation of gingival tissue	234
7.2.2	Morphology and viability of gingival CT explants.....	234
7.2.3	Degradation of gingival CT ECM after stimulation with IL-1+OSM	235
7.3	Regulation of collagen degradation in gingival CT by leptin and IL-1 α	237
7.4	Discussion	238
8	Chapter 8. Discussion	256
8.1	Future work	260
A.	Appendix A. The effect of chemical signalling pathway inhibitors on hGF proliferation.....	264
B.	Appendix B. The effect of chemical signalling pathway inhibitors on intracellular signalling in hGFs.	269
C.	Appendix C. Real-time RT-PCR.....	271
D.	Appendix D: The human immune panel TLDA.	273
E.	Appendix E. Human HT-12 v4 genome-wide expression beadchip.....	276

F. Appendix F. hGF proliferation after stimulation with leptin and inflammatory mediators	284
G. Appendix G. Time course of STAT3 and ERK phosphorylation in hGFs after stimulation with leptin.	288
H. Appendix H. MMP-1 gene expression in hGFs in the presence of DMSO.	289
I. Appendix I. Stimulation of hGFs with leptin and a leptin antagonist.....	290
J. Appendix J. Preliminary experiments for microarray analysis of gene expression in hGFs	291
K. Appendix K. ELISA standard curves.....	294
L. List of presentations and manuscripts	296
9 References	298

List of figures

Figure 1.1: The functions of leptin.....	45
Figure 1.2: Aspects of the leptin signalling pathway.....	47
Figure 1.3: Haematoxylin and eosin section of the healthy human gingiva.....	48
Figure 2.1: hGFs <i>in vitro</i>	74
Figure 2.2: hGFs are vimentin positive.....	75
Figure 2.3: The effect of serum on hGF proliferation.....	77
Figure 2.4: Forward and side scatter properties of hGFs.....	80
Figure 2.5: Representative standard curve for the Bradford assay.....	82
Figure 2.6: A representative standard plot for the GAG assay.....	84
Figure 2.7: Representative standard plot for the hydroxyproline assay.....	85
Figure 2.8: MMP activity in spiked assay buffer and tissue culture medium.....	87
Figure 3.1: MMP-1 mRNA expression in hGFs after leptin stimulation.....	105
Figure 3.2: MMP-1 mRNA expression in hGFs after different durations of leptin stimulation.....	107
Figure 3.3: MMP-1 protein secretion by hGFs after different durations of leptin stimulation.....	108
Figure 3.4: MMP-2 mRNA expression in hGFs after leptin stimulation.....	109
Figure 3.5: MMP-3 mRNA expression in hGFs after leptin stimulation.....	110
Figure 3.6: TIMP-2 and MMP-10 gene expression in hGFs after leptin stimulation.....	112
Figure 3.7: MMP-14 gene expression in hGFs after leptin stimulation.....	113
Figure 3.8: TIMP-1 gene expression in hGFs after leptin stimulation.....	114
Figure 3.9: hGF proliferation after stimulation with leptin.....	115
Figure 4.1: MMP-1 gene expression in hGFs after stimulation with leptin and IL-1 α	136
Figure 4.2: MMP-1 protein secretion by hGFs after stimulation with leptin and IL-1 α	137
Figure 4.3: MMP-3 gene expression in hGFs after stimulation with leptin, IL-1 α and OSM.....	139
Figure 4.4: MMP-3 protein secretion by hGFs after stimulation with leptin and IL-1 α	140
Figure 4.5: MMP-2 gene expression in hGFs after stimulation with leptin and OSM.....	141
Figure 4.6: MMP-14 gene expression in hGFs after stimulation with leptin and IL-1 α	142

Figure 4.7: TIMP-2 and MMP-10 gene expression in hGFs after stimulation with leptin, IL-1 α and OSM.	143
Figure 4.8: MMP-1 gene expression in hGFs after stimulation with leptin and pam2CSK4.	146
Figure 4.9: MMP-1 protein secretion by hGFs after stimulation with leptin and pam2CSK4.	147
Figure 4.10: MMP-14 gene expression in hGFs after stimulation with leptin and pam2CSK4.	149
Figure 4.11: TLR2 surface expression on hGFs.	150
Figure 4.12: TLR4 surface expression on hGFs.	153
Figure 5.1: Long isoform leptin receptor gene expression in hGFs.	170
Figure 5.2: Leptin receptor surface expression on hGFs.	171
Figure 5.3: Phosphorylation status of MAPK signalling pathway intermediates in hGFs after stimulation with leptin, IL-1, pam2CSK4 and OSM.	172
Figure 5.4: Phosphorylation status of STAT1 and STAT3 in hGFs after stimulation with leptin, IL-1, pam2CSK4 and OSM.	173
Figure 5.5: Phosphorylation status of Akt in hGFs after stimulation with leptin, IL-1, pam2CSK4 and OSM.	174
Figure 5.6: Phosphorylation status of NF- κ B p65 in hGFs after stimulation with leptin, IL-1, pam2CSK4 and OSM.	175
Figure 5.7: The role of MEK/ERK in regulating MMP-1 gene expression by stimulated hGFs.	177
Figure 5.8: The role of JNK in regulating MMP-1 gene expression by stimulated hGFs.	178
Figure 5.9: The role of p38 in regulating MMP-1 gene expression by stimulated hGFs.	179
Figure 5.10: The role of STAT3 in regulating MMP-1 gene expression by stimulated hGFs.	180
Figure 5.11: The role of AKT in regulating MMP-1 gene expression by stimulated hGFs.	181
Figure 6.1: IL-6 secretion by hGFs after stimulation with leptin and IL-1	206
Figure 6.2: MMP-1 gene expression in hGFs after stimulation with IL-1 α and IL-1 β	207
Figure 6.3: MMP-1 protein secretion by hGFs after stimulation with IL-1 α and IL-1 β	208
Figure 6.4: MMP-1 gene expression in hGFs after stimulation with leptin and IL-1 β	209

Figure 6.5: Venn diagram displaying the relationship between differentially expressed genes in hGFs after stimulation with leptin, IL-1 or leptin+IL-1	210
Figure 6.6: Leptin+IL-1 stimulated differentially expressed genes in hGFs represented on the RA KEGG pathway.....	222
Figure 6.7: Real-time PCR analysis of genes chosen for further study from microarray analysis.....	229
Figure 6.8: IL-24 secretion by hGFs after stimulation with leptin and IL-1.....	230
Figure 7.1: Histology of a piece of gingival tissue acquired in this study.	245
Figure 7.2: Potential adipocytes in gingival connective tissue.	246
Figure 7.3: Adipocytes in gingival connective tissue	247
Figure 7.4: Cumulative GAG release from gingival tissue explants over time.	248
Figure 7.5: Cumulative hydroxyproline release from IL-1+OSM stimulated gingival tissue explants over time.	249
Figure 7.6: MMP activity in IL-1+OSM stimulated gingival tissue culture supernatants over time.....	251
Figure 7.7: Cumulative hydroxyproline release from leptin+IL-1 stimulated gingival tissue explants over time.	252
Figure 7.8: Cumulative hydroxyproline release from leptin+IL-1 stimulated gingival tissue explants.	253
Figure 7.9: MMP activity in gingival tissue culture supernatants after stimulation with leptin and IL-1.....	254
Figure 7.10: MMP activity in gingival tissue culture supernatants after stimulation with leptin+IL-1 and treatment with GM6001.....	255
Figure 8.1: Schematic diagram illustrating the hypothetical role of leptin in regulating fibroblast function in the gingiva.	263

Appendix figures

Figure A.1: Dose response relationships between signalling pathway inhibitors and hGF proliferation.....	268
Figure B.1: Chemical inhibition of the phosphorylation of signalling pathway intermediates.	270
Figure C.1: A representative amplification plot for real-time RT-PCR analysis.....	271
Figure C.2: Comparison of 18S rRNA and RNAP gene expression in hGFs.....	272
Figure D.1: Expression of selected genes on the immune TLDA in leptin-stimulated hGFs.....	275

Figure E.1: The direct hybridisation assay.....	276
Figure E.2: QC data for the HT-12 genome-wide microarrays.	281
Figure E.3: Genome-wide expression profiles of hGFs after stimulation with leptin and IL-1 β	283
Figure F.1: hGF proliferation after stimulation with leptin, IL-1 α and OSM.....	285
Figure F.2: hGF proliferation after stimulation with leptin, pam2CSK4 and <i>E. coli</i> LPS	287
Figure G.1: Phosphorylation status of STAT3 and ERK in hGFs after stimulation with leptin.....	288
Figure H.1: DMSO does not affect MMP-1 gene expression in stimulated hGFs.	289
Figure I.1: MMP-1 production and STAT3 tyrosine phosphorylation in hGFs after stimulation with leptin and a leptin antagonist.	290
Figure J.1: hGF proliferation after stimulation with IL-1 α or IL-1 β	291
Figure J.2: MMP-1 gene expression in hGFs after stimulation with leptin and IL-1 β .	292
Figure K.1: Representative standard curves for the ELISAs used in this study.	295

List of tables

Table 1.1: The mammalian MMPs.	49
Table 2.1: A summary of the plastic-ware formats, seeding densities and endpoints used throughout this study.	76
Table 2.2: The forward and reverse primer and probe sequences used for RT-PCR analysis of gene expression.	78
Table 2.3: Details of the antibodies used for flow cytometry.	79
Table 2.4: Absorbance values derived from the Bradford assay.	81
Table 2.5: Targets, species of origin, dilutions and suppliers for antibodies used in this study.	83
Table 2.6: Comparison of FS6 assay controls at different sensitivities.	86
Table 3.1: MMP and TIMP gene expression in hGFs under basal conditions and after stimulation with leptin.	104
Table 3.2: MMP-1 protein secretion by hGFs after leptin stimulation.	106
Table 3.3: MMP-3 protein secretion by hGFs stimulated with leptin.	111
Table 4.1: MMP and TIMP expression in hGFs after stimulation with leptin (0.1 µg/ml), IL-1 and OSM.	134
Table 4.2: MMP and TIMP expression in hGFs after stimulation with leptin (10 µg/ml), IL-1 and OSM.	135
Table 4.3: MMP-1 and MMP-3 secretion by hGFs after stimulation with leptin (10 µg/ml), IL-1 and OSM.	138
Table 4.4: MMP-1 and MMP-3 secretion by hGFs after stimulation with two concentrations of pam2CSK4 or <i>E. coli</i> LPS.	144
Table 4.5: MMP and TIMP expression in hGFs after stimulation with leptin, pam2CSK4 and <i>E. coli</i> LPS.	145
Table 4.6: MMP-3 protein secretion by hGFs stimulated with leptin and pam2CSK4.	148
Table 4.7: MMP-1 production in hGFs after stimulation with leptin and <i>E. coli</i> LPS.	151
Table 4.8: MMP-3 protein secretion by hGFs after stimulation with leptin and <i>E. coli</i> LPS.	152
Table 5.1: The inhibitors of intracellular signalling pathway intermediates used in this study.	176
Table 6.1: Expression levels of genes on the immune TLDA in leptin-stimulated hGFs.	205

Table 6.2: Selection of differentially expressed genes in hGFs after leptin stimulation	211
Table 6.3: Selected GO term processes significantly overrepresented in hGFs after leptin treatment.....	212
Table 6.4: KEGG pathways significantly overrepresented in hGFs after leptin treatment.	213
Table 6.5: Selection of differentially expressed genes in hGFs after IL-1 stimulation	214
Table 6.6: Selected GO term processes significantly overrepresented in hGFs after IL-1 treatment.....	215
Table 6.7: KEGG pathways significantly overrepresented in hGFs after IL-1 treatment.	216
Table 6.8: Selection of differentially expressed genes in hGFs after leptin+IL-1 stimulation.....	217
Table 6.9: Selected GO term processes significantly overrepresented in hGFs after leptin+IL-1 treatment.	219
Table 6.10: KEGG pathways significantly overrepresented in hGFs after leptin+IL-1 treatment.....	220
Table 6.11: Selected differentially expressed genes in hGFs potentially synergistically regulated by leptin+IL-1	223
Table 7.1: Total amount of hydroxyproline is associated with hydroxyproline release and MMP activity from IL-1+OSM stimulated gingival tissue pieces	250

Appendix tables

Table D.1: List of genes on the human immune panel TLDA.....	273
Table J.1: hGF RNA concentration and quality assessment for the genome-wide expression microarray	293

List of abbreviations

α 2M	α 2-macroglobulin
AGE	advanced glycation end-product
AIR	acute inflammatory reaction
AMC	7-amino-4-methylcoumarin
APMA	4-aminophenylmercuric acetate
AP-1	activator protein-1
APS	ammonium persulphate
ATF	activating transcription factor
β 2m	β 2-microglobulin
BAL	bronchoalveolar lavage
BMI	body mass index
BOP	bleeding on probing
BSA	bovine serum albumin
CAL	clinical attachment loss
cDNA	complementary DNA
C/EBP	CCAAT-enhancer-binding protein
CEJ	cemento-enamel junction
CGS	Cambridge Genomic Services
CNS	central nervous system
CRH	cytokine receptor homology
cRNA	complementary RNA
CSF	colony-stimulating factor
CT	connective tissue
C_t	threshold cycle
CV	coefficient of variance
DAB	4-(dimethylamino)benzaldehyde
DC	dendritic cell
DMB	dimethyl-methylene blue
DMEM	Dulbecco's modified eagle medium
DMEM+	Dulbecco's modified eagle medium supplemented with 10 % v/v FBS
DMSO	dimethyl sulphoxide
dNTP	deoxyribonucleotide triphosphate
ECL	enhanced chemiluminescence

ECM	extracellular matrix
EDTA	ethylenediaminetetraacetic acid
EGF	epidermal growth factor
EHOM	engineered human oral mucosa
ELISA	enzyme-linked immunosorbant assay
EMPRIN	extracellular MMP inducer
ERK	extracellular signal-related kinase
FACS	fluorescence-activated cell sorting
FBS	foetal bovine serum
FRET	fluorescence resonance energy transfer
GAG	glycosaminoglycan
GAPDH	glyceraldehyde-3'-phosphate dehydrogenase
GCF	gingival crevicular fluid
GO	gene ontology
GRB2	growth factor receptor-bound protein 2
hGF	human gingival fibroblast
HMGB1	high mobility group box-1
HRP	horseradish peroxidase
HSC	hepatic stellate cell
HUVEC	human umbilical vein endothelial cell
H+E	haematoxylin and eosin
IBD	inflammatory bowel disease
IDO	indoleamine 2, 3-dioxygenase
IFN	interferon
IHC	immunohistochemistry
IKK	I κ B kinase
IL	Interleukin
JNK	c-Jun N-terminal kinase
kDa	kilo Dalton
KEGG	Kyoto encyclopaedia of genes and genomes
LAL	Limulus ameocyte lysate
LDH	lactate dehydrogenase
LIF	leukaemia inhibitory factor
LPS	lipopolysaccharide
MAPK	mitogen-activated protein kinase

MEK	MAPK/Erk kinase
MMP	matrix metalloproteinase
mRNA	messenger RNA
NAC	no antibody control
NF- κ B	nuclear factor κ B
OHP	hydroxyproline
OPG	osteoprotegerin
OR	odds ratio
OSM	oncostatin M
PA	plasminogen activator
PAGE	polyacrylamide gel electrophoresis
PAI-1	plasminogen activator inhibitor-1
PBS	Dulbecco's phosphate buffered saline
PCA	principal component analysis
PD	pocket depth
PDL	periodontal ligament
PE	phycoerythrin
PG	prostaglandin
PI3K	phosphoinositide 3-kinase
PRR	pathogen recognition receptor
PTGS2	prostaglandin-endoperoxide synthase 2
PTP1B	protein tyrosine phosphatase 1B
QC	quality control
RA	rheumatoid arthritis
RANKL	receptor activator of NF- κ B ligand
RFU	relative fluorescence units
RNAP	RNA polymerase II
ROS	reactive oxygen species
rRNA	ribosomal RNA
RSI	root surface instrumentation
RT	room temperature
RT-PCR	reverse transcription-PCR
SCID	severe combined immunodeficiency
SD	standard deviation
SDD	sub-antimicrobial dose doxycycline

SDS	sodium dodecyl sulphate
SFM	serum-free DMEM
SFK	Src family kinase
SH	Src homology
SOCS3	suppressor of cytokine signalling 3
SOS	Son of Sevenless
STAT	signal transducer and activator of transcription
T2DM	type 2 diabetes mellitus
TBS	TRIS-buffered saline
TBS/T	TBS Tween-20
TEMED	tetramethylethylenediamine
TGF	transforming growth factor
TIMP	tissue inhibitor of metalloproteinases
TLDA	TaqMan low density array
TLR	Toll-like receptor
TNF	tumour necrosis factor
TRIS	tris(hydroxymethyl)aminomethane
VEGF	vascular endothelial growth factor
4PL	four parameter logistic

1 Chapter 1. Introduction

In the 1950s and 1960s two mutant mice strains arose which displayed similar phenotypes (Friedman and Halaas, 1998). Homozygote mutants of both strains were extremely obese (weighing approximately three-times wild-type animals), suffered from diabetes, but showed signs of starvation (Myers *et al.*, 2008). Using parabiosis experiments (sharing the blood circulation between two mice) Friedman deduced that the obese strain (*ob/ob*) had a mutation in a soluble factor that regulated feeding and adipose tissue mass (Coleman, 2010). These experiments also suggested that the other mouse strain (*db/db*) had a mutation in the receptor for the *ob* gene product. The product of the *ob* gene was subsequently identified in 1994 by positional cloning techniques and named leptin (Zhang *et al.*, 1994). Similarly, the leptin receptor, and product of the *db* gene, was identified in 1995 (Tartaglia *et al.*, 1995).

1.1 Biological importance of leptin

Leptin is a 16 kDa protein hormone that regulates adipose tissue mass by reducing food intake; a function controlled primarily by the hypothalamus (Friedman and Halaas, 1998). Leptin is secreted by adipocytes in proportion to total adipose tissue mass (Maffei *et al.*, 1995). Therefore, increased circulating leptin levels indicate abundant adipose tissue energy stores, while decreased circulating leptin levels signal the opposite (Kelesidis *et al.*, 2010). In non-obese humans, fasting blood leptin concentrations are usually < 30 ng/ml and are significantly higher in women compared to men (Considine *et al.*, 1996). This is attributed to the difference in adipose tissue mass between the sexes (Maffei *et al.*, 1995). As evidenced by the obese phenotypes of *ob/ob* and *db/db* mice, and humans with mutations in the leptin gene (*LEP*), the primary function of leptin is to inform the brain of energy reserves and to regulate energy expenditure (Figure 1.1) (Myers *et al.*, 2008). In the central nervous system (CNS), leptin activates intracellular signalling pathways in different types of neurons within the hypothalamus that express the leptin receptor (Coppari and Bjorbaek, 2012). This activates complex pathways involving the production of downstream neurotransmitters and hormones that reduce feeding, increase the metabolic rate, and increase insulin sensitivity. As such, leptin is considered to be a satiety factor (Kelesidis *et al.*, 2010).

Mice and humans that lack leptin signalling also exhibit reduced reproductive capacity and immunocompetence (Kelesidis *et al.*, 2010). These physiological defects are reported in cases of malnourishment and are hypothesised to be reduced to improve an

individuals' chance of survival during a period of starvation (Matarese *et al.*, 2005). Therefore, leptin is hypothesised to be a link between nutrition, reproduction and immunity. In support of this hypothesis the leptin receptor has been detected on cells of the haematopoietic lineage including lymphocytes and macrophages/monocytes (Uddin *et al.*, 2010), which suggests that leptin can act directly on these cells. Indeed, a recent study found that the reduced capacity for T lymphocyte activity observed in fasting mice could be rescued by leptin directly signalling to T lymphocytes (Saucillo *et al.*, 2014). Interestingly, the leptin receptor is expressed on other cell types including human endothelial cells, fibroblasts and macrophages (Sierra-Honigsmann *et al.*, 1998; Glasow *et al.*, 2001; Gruen *et al.*, 2007). Similarly, immunohistochemistry (IHC) analyses have found that leptin is present in peripheral tissues (Vernooy *et al.*, 2010). The role of leptin on these cells and at these sites is only just beginning to be unravelled (Section 1.4) (Figure 1.1), and suggests that the biological importance of leptin is more wide-ranging than initially thought.

1.2 Intracellular signalling pathways stimulated by leptin

Since leptin and the leptin receptor were identified and sequenced in the 1990s much research has been undertaken to understand how leptin binds to the leptin receptor, the intracellular signalling pathways this interaction activates, and how these pathways relate to the physiological functions of leptin *in vivo*. (Myers *et al.*, 2008)

1.2.1 Structural features of leptin and the leptin receptor

Structural investigations demonstrated that leptin is a member of the four α -helix bundle cytokine family (Kline *et al.*, 1997). The four α -helix bundle cytokine family has several sub-families and leptin shares structural features with members of the interleukin (IL)-6 cytokine family (Fantuzzi and Faggioni, 2000). However, unlike the other members of the IL-6 cytokine family, leptin has a unique structural feature called a cysteine knot (Haglund *et al.*, 2012). Interestingly, Haglund *et al.* (2012) found that the ability of leptin to activate intracellular signalling *in vitro* was reduced when the disulphide bond responsible for the cysteine knot was absent (due to reducing conditions or molecular substitution of cysteine residues). Whether or not this structural feature is important *in vivo* is not yet known.

The leptin receptor is structurally related to members of the type I cytokine receptor family; a classification based on structural similarity and the presence of cytokine receptor homology (CRH) domains (Fantuzzi and Faggioni, 2000). This cytokine

receptor family includes gp130, leukaemia inhibitory factor (LIF) receptor and granulocyte colony-stimulating factor (CSF) receptor (Tartaglia *et al.*, 1995). Several leptin receptor isoforms have been identified; these isoforms are generated by alternative splicing and are categorised in humans as long or short, depending on the length of the intracellular domain (Kelesidis *et al.*, 2010). Soluble leptin receptor is detected in the circulation and in humans is thought to be secreted by ectodomain shedding; in contrast mice express a secreted leptin receptor isoform that lacks a transmembrane region (Ge *et al.*, 2002). Soluble leptin receptor was shown to inhibit leptin-mediated intracellular signalling in leptin receptor-transfected human embryonic kidney cells (Schaab *et al.*, 2012), and therefore soluble leptin receptor is thought to regulate the availability of free leptin. Electron microscopic analysis of leptin/leptin receptor crystals, and studies using leptin receptors with specific sequence alterations, have shown that leptin binds to the CRH2 domain found on the extracellular region of the leptin receptor (Peelman *et al.*, 2004).

1.2.2 Leptin signalling pathway activation

The intracellular region of the leptin receptor has no intrinsic kinase activity (Kelesidis *et al.*, 2010). However, the intracellular membrane proximal region of the short and long leptin receptor isoforms contains binding sites for Janus kinase 2 (JAK2) and Src family kinases (SFKs); and both JAK2 and SFKs are constitutively bound to the leptin receptor (Coppari and Bjorbaek, 2012) (Figure 1.2). Fluorescence resonance energy transfer (FRET)-based studies using living cells have shown that a dimeric form of the leptin receptor is required to activate intracellular signalling, and that the long leptin receptor isoform is found as a dimer constitutively (Couturier and Jockers, 2003). This supports the hypothesis that a 2:2 ratio of leptin/leptin receptor is required for leptin to initiate intracellular signalling; JAK2 and SFKs activate by transphosphorylation between leptin receptor monomers and phosphorylate several tyrosine residues (Y985, Y1077, Y1138) on the intracellular region of the long leptin receptor isoform membrane distal to the JAK2 binding site (Mancour *et al.*; Coppari and Bjorbaek, 2012). The short leptin receptor isoforms lack much of the intracellular region of the leptin receptor, including these tyrosine residues, but can still facilitate some intracellular signalling via JAK2 (Bjorbaek *et al.*, 1997). However, *in vivo* studies using truncated leptin receptors in mice have shown that the metabolic and endocrine functional outcomes of leptin signalling require the phosphorylation of the tyrosine residues found in the long leptin

receptor isoform (Myers, 2010). As such, much of the research on leptin signalling has focussed on the long leptin receptor isoform.

Phospho-tyrosine residues on the leptin receptor form binding sites for Src homology (SH)2 domain-containing proteins which are then activated by JAK2 or SFKs (Coppari and Bjorbaek, 2012). *In vitro* and *in vivo* approaches using mutant leptin receptors (lacking Y985, Y1077 and/or Y1138) have demonstrated that each of these phosphorylated residues favours the binding and activation of different signalling pathway intermediates (Myers, 2010). For example, Y1077 is necessary for maximum signal transducer and activator of transcription (STAT) 5, STAT1 and STAT6 activity (Gong *et al.*, 2007; Coppari and Bjorbaek, 2012). Leptin-receptor bound STATs are phosphorylated and activated by JAK2 (Myers *et al.*, 2008). Activated STATs form dimers which translocate to the nucleus, where STATs enhance gene expression by binding to interferon (IFN)- γ -activated sequences or IFN-stimulated response elements in the promoter regions of a wide range of genes (Bezbradica and Medzhitov, 2009). Y1138 is necessary for STAT3 activity and it is this arm of the leptin signalling pathway which is responsible for many of the hormonal functions of leptin that regulate body weight (Myers, 2010). The phosphatase Shp2 binds to phosphorylated Y985 and acts as a binding site for growth factor receptor-bound protein 2 (GRB2); GRB2 drives the activation of the mitogen-activated protein kinase (MAPK) signalling pathway (Coppari and Bjorbaek, 2012). GRB2 contains SH3 domains which the guanine nucleotide exchange factor Son of Sevenless (SOS) binds to (Rojas *et al.*, 2011). This relocation of SOS to the plasma membrane brings it in contact with its substrate, Ras. SOS-activated Ras then activates upstream proteins in the MAPK signalling pathway (Mor and Philips, 2006). The MAPK signalling pathway consists of a kinase cascade whereby an active upstream kinase phosphorylates and activates a downstream kinase. There are several arms of the MAPK signalling cascade, named according to the terminal MAPK molecule (extracellular signal-related kinase (ERK), p38, c-Jun N-terminal kinase (JNK)). Each of these terminal MAPK molecules can phosphorylate, and thereby activate, several transcription factors including c-Fos, c-Jun, CCAAT-enhancer-binding proteins (C/EBP) and activating transcription factor (ATF) 2. The gene targets upregulated by these transcription factors span a broad range of functions. Additionally, MAPK signalling can enhance the activity of STATs and the nuclear factor κ B (NF- κ B) signalling pathway (Morris and Rui, 2009).

Leptin also activates phosphoinositide 3-kinase (PI3K), Akt/protein kinase B, mammalian target of rapamycin and NF- κ B signalling (Zhou *et al.*, 2011; Coppari and Bjorbaek, 2012). It is thought that leptin-mediated PI3K activity requires JAK2 but not the phosphorylation of tyrosine residues on the leptin receptor (Tong *et al.*, 2008). Therefore, PI3K activity may occur downstream of both short and long leptin receptor isoforms. Leptin-mediated PI3K activity regulates cellular growth (Jaffe and Schwartz, 2008; Shan *et al.*, 2008; Valerio *et al.*, 2009; Uddin *et al.*, 2010), motility (Gruen *et al.*, 2007), glucose sensitivity (Coppari and Bjorbaek, 2012) and neurone action potentials (Hill *et al.*, 2008).

1.2.3 Regulation of the leptin signalling pathway

The leptin signalling pathway is fairly well described in neurones and transfected cell lines, but less is known about how leptin signalling varies between cell types (Coppari and Bjorbaek, 2012). As the leptin signalling pathway is complex, there are gaps in our understanding about how the different arms of the leptin signalling pathway are regulated and how they interact. Negative regulators of leptin signalling (suppressor of cytokine signalling 3 (SOCS3), protein tyrosine phosphatase 1B (PTP1B)) have been described (Morris and Rui, 2009). PTP1B and presumably other phosphatases negatively regulate leptin signalling by dephosphorylating, and thereby inactivating, the leptin receptor and associated proteins; the mechanisms of SOCS3 inhibition of leptin signalling are not fully understood (Coppari and Bjorbaek, 2012). Positive regulators of the leptin signalling pathway such as SH2B adaptor protein 1 have been identified but exactly how they function is unclear (Morris and Rui, 2009). Mechanisms of interaction between cytokine signalling pathways include cross-talk/feedback, amplification of downstream pathways and convergence of multiple pathways to a single downstream molecule (Bezradica and Medzhitov, 2009). It is likely that all of these mechanisms occur during leptin signalling.

The signalling pathways activated by leptin are similar to those activated by other agonists of the type I cytokine receptor families (Tartaglia, 1997). Therefore, the magnitude of activity of these shared intracellular signalling pathways could be altered if a cell is exposed to leptin in combination with other stimuli. For example, there is crosstalk between the insulin and leptin signalling pathways in the CNS (Carvalho *et al.*, 2005). Specifically, Carvalho *et al.* (2005) found that insulin and leptin signalling converged at PI3K, but diverged downstream at Akt in the rat hypothalamus. Similarly, crosstalk at the level of STAT signalling has been described between leptin and

oestrogen in the CNS (Gao and Horvath, 2008). Leptin can also crosstalk with other stimuli at the level of intracellular signalling in cells outside of the CNS. For example, leptin and insulin-like growth factor-1 synergistically increase Akt and ERK signalling in breast cancer cells, thereby increasing the potential of these cells to invade and migrate (Saxena *et al.*, 2008). In human articular chondrocytes leptin and IL-1 synergistically increase the expression of MMPs by amplifying MAPK signalling (Hui *et al.*, 2012). There are multiple possibilities, thus there is scope for further research in this area because cellular microenvironments are variable. For example, the cellular microenvironment may change depending on local energy supplies, or during infection and inflammation. By understanding the intricacies of leptin signalling in different contexts it may be possible to identify how variation, dysregulation and defects in leptin signalling and therefore function, can contribute to human disease.

1.3 Obesity, diabetes and leptin resistance

The prevalences of metabolic disorders, such as obesity and type 2 diabetes mellitus (T2DM), are increasing at an alarming rate globally, presumably due to changes in diet and lifestyle (Malik *et al.*, 2013). Central (or abdominal) obesity and impaired insulin sensitivity (as observed in T2DM) are both features of metabolic syndrome (Bullon *et al.*, 2009). Definitions of metabolic syndrome vary but usually require an individual to have elevated blood pressure and dyslipidaemia, as well as signs of insulin resistance and obesity (Hotamisligil, 2006; Pischon *et al.*, 2007). Between 5 – 20 % of the world population is estimated to have metabolic syndrome (Alberti *et al.*, 2006). Obesity and T2DM are a costly burden to health services and are associated with increased morbidity and mortality in affected populations (Malik *et al.*, 2013). Systemic markers of oxidative stress and chronic inflammation have been detected in individuals who have metabolic syndrome. As such, mediators of oxidative stress and inflammation have been suggested to play a mechanistic role in the relationship between metabolic syndrome and other conditions associated with oxidative stress and chronic inflammation, such as periodontitis and cardiovascular disease (Hotamisligil, 2006; Bullon *et al.*, 2009).

Individuals with T2DM have a reduced ability to metabolise blood glucose and, therefore, T2DM is characterised by the World Health Organisation (2006) as having a fasting blood glucose level of > 7 mM. In contrast, obesity is determined in several ways; such as by measuring the waist to hip ratio, by assessing body fat composition

and distribution, and by calculating the body mass index (BMI) (Alberti *et al.*, 2006). BMI is calculated using the formula:

$$BMI = weight (kg) \div (height (m))^2$$

Adults with a BMI > 25 are generally considered overweight and those with a BMI > 30 are considered obese, although ethnic and gender differences complicate these broad definitions (Alberti *et al.*, 2006). Both genetic and environmental factors contribute to the risk of obesity and T2DM, and therefore, these disorders have a complex molecular basis (Kolb and Mandrup-Poulsen, 2010). For example, mutations in the leptin or leptin receptor genes in rodents and humans result in extreme obesity and endocrine dysfunction (Clement *et al.*, 1998). However, most obese individuals have increased circulating leptin levels (Coppari and Bjorbaek, 2012). In contrast, individuals with a lower adipose tissue mass (e.g. due to lipodystrophy) have reduced circulating leptin concentrations (Petersen *et al.*, 2002). This is not surprising given the relationship between adipose tissue mass and leptin production (Maffei *et al.*, 1995). However, this appears to contradict the evidence that increased levels of leptin stimulate the neuroendocrine pathways that control appetite and metabolism in an effort to reduce adipose tissue mass (Friedman and Halaas, 1998). Obese individuals with increased circulating leptin concentrations often remain obese, and even gain more weight, suggesting that the body develops a resistance to leptin (Coppari and Bjorbaek, 2012). This has similarities to the resistance to insulin that develops in T2DM (Hotamisligil, 2006). Regarding leptin, resistance makes sense from an evolutionary perspective as starving was presumably a greater cause of death than being in energy excess; this suggests that the dominant function of leptin is to signal starvation, not energy excess (Friedman and Halaas, 1998). Interestingly, circulating leptin levels are uncoupled from adiposity and energy balance in mammals in two normal physiological processes, namely hibernation (Kronfeld-Schor *et al.*, 2000) and pregnancy (Tessier *et al.*, 2013).

Studies using mouse models identified that during obesity leptin-stimulated neurons increase the production of SOCS3 and PTP1B, which may reduce leptin signalling (Section 1.2) (Munzberg *et al.*, 2004; Gamber *et al.*, 2012). However, increased CNS concentrations of leptin and proinflammatory cytokines in addition to endoplasmic reticulum stress are all implicated in the development of leptin resistance in neurons (Coppari and Bjorbaek, 2012). It is hypothesised that there is a threshold concentration of leptin above which there is no increase in the strength of leptin signalling, e.g. the

leptin signalling pathway is saturated (Mantzoros *et al.*, 2011). This relates to the idea that leptin signals starvation, and not energy excess (Friedman and Halaas, 1998). Interestingly, there is evidence that essentially identical neurones differentially respond to leptin (Williams *et al.*, 2010). Pro-opiomelanocortin neurones (which regulate leptin-mediated insulin sensitivity) activate leptin signalling in a manner distinct to the leptin-sensitive γ -aminobutyric acid neurones (which regulate body weight) (Coppari and Bjorbaek, 2012). Furthermore, the differential ability of leptin to regulate insulin sensitivity and body weight have been determined in both *in vivo* studies in mice (Jager *et al.*, 2011), and clinical trials in humans who are hypoleptinaemic (Petersen *et al.*, 2002). These studies suggest that the different functional responses of leptin are regulated independently of each other, due to cell- or signalling-specific mechanisms. Most of the current studies of leptin resistance have investigated CNS leptin resistance (Myers *et al.*, 2008; Morris and Rui, 2009; Coppari and Bjorbaek, 2012). Peripherally, there is some evidence to support leptin resistance in adipose tissue (Mantzoros *et al.*, 2011), skeletal muscle (Steinberg *et al.*, 2002) and cardiomyocytes (Radin *et al.*, 2011). One complication of studying leptin sensitivity in peripheral tissue, and/or using *in vitro* models, is that it is difficult to determine the relative effects of central leptin signalling compared to direct leptin action on peripheral cells.

There is currently a large global population of hyperleptinaemic individuals; including those who are obese, and those treated with exogenous leptin as a therapy (Kelesidis *et al.*, 2010). Central leptin resistance has been well studied but the mechanisms underlying this phenomenon appear to be cell-type and signal dependent (Coppari and Bjorbaek, 2012). Even less is understood about peripheral leptin sensitivity and resistance. It is plausible that peripheral leptin-responsive sites have a different sensitivity to leptin compared to the CNS. Could some peripheral sites remain sensitive to leptin, or only be exposed to leptin, during hyperleptinaemia? What are the functional implications of this? Further studies investigating the sensitivity of non-CNS sites to leptin are warranted, particularly at those sites relevant to energy metabolism, endocrine function, reproduction and immunocompetence.

1.4 Leptin as a regulator of immunity, inflammation and wound healing

Mice and humans that lack leptin signalling exhibit reduced immunocompetence (Kelesidis *et al.*, 2010). Leptin and the leptin receptor are structurally homologous to IL-6 cytokines and type I cytokine receptors respectively (Section 1.2) (Fantuzzi and Faggioni, 2000). IL-6 family cytokines have wide-ranging local and systemic functions,

and are particularly well studied in regard to inflammation, immunity and wound healing (Taga and Kishimoto, 1997a). Leptin was hypothesised to have similar functions, and numerous studies have provided evidence to support this hypothesis (Matarese *et al.*, 2005).

1.4.1 *Leptin and leukocyte recruitment*

Intraperitoneal administration of leptin in a mouse model of chronic obstructive pulmonary disease causes an increased infiltration of neutrophils, T cells and dendritic cells (DCs) in bronchoalveolar lavage (BAL) fluid (Vernooy *et al.*, 2010), suggesting that leptin promotes leukocyte infiltration into inflamed lungs. However, Vernooy *et al.* (2010) found that the levels of the chemokines CXCL1 and CCL2 in BAL were increased in *ob/ob* and *db/db* mice compared to wild-type controls, suggesting that in this model leptin-mediated leukocyte infiltration was not due to enhanced lung CXCL1 or CCL2 production. Leptin dose-dependently increases chemokine receptor CCR7 expression on human colon DCs in Crohn's disease, and this increase in chemokine receptor expression is responsible for enhanced DC migration (Al-Hassi *et al.*, 2013). This suggests that leptin may promote chemotaxis by increasing the expression of chemokine receptors on leukocytes. Leptin increases the *in vitro* production of CCL2 by activated, myofibroblast-like human hepatic stellate cells (HSCs) (Aleffi *et al.*, 2005), increases CXCL8 expression by synovial fibroblasts (Tong *et al.*, 2008), and increases CCL3/CCL4/CCL5 expression by murine macrophages (Kiguchi *et al.*, 2009). These studies suggest that leptin may promote leukocyte chemotaxis by promoting the production of chemokines by tissue-resident cells. Intriguingly, leptin itself acts as a chemoattractant for murine peritoneal monocytes/macrophages and the human THP-1 monocytic cell line *in vitro* (Gruen *et al.*, 2007), however, no mechanistic explanation for this finding was described. Overall, leptin appears to promote leukocyte chemotaxis which may function to promote tissue inflammatory responses.

1.4.2 *Leptin regulation of leukocyte function*

Monocytes, macrophages, DCs, mast cells, eosinophils and natural killer cells all express the leptin receptor (Fernandez-Riejós *et al.*, 2010). Only the short isoform of the leptin receptor is expressed in neutrophils (Zarkesh-Esfahani *et al.*, 2004), although this appears sufficient to drive leptin-mediated neutrophil survival (Bruno *et al.*, 2005). Similarly, leptin promotes the survival and proliferative ability of monocytes (Sanchez-Margalet *et al.*, 2003) and DCs (Mattioli *et al.*, 2009). Leptin also has an indirect effect on the circulating numbers of leukocytes, by affecting haematopoiesis in the bone

marrow and foetal liver (Fernandez-Riejos *et al.*, 2010). Overall, these findings suggest that leptin acts as a growth factor for innate leukocytes.

Leptin increases the differentiation and activation of monocytes (Sanchez-Margalet *et al.*, 2003; Fernandez-Riejos *et al.*, 2010). For example, leptin increases the surface expression of the innate pattern recognition receptor (PRR) Toll-like receptor (TLR)-2 on monocytes (Jaedicke *et al.*, 2013), and regulates the production of monocyte-derived proinflammatory cytokines (tumour necrosis factor (TNF)- α /IL-6/IFN- γ) (Zarkesh-Esfahani *et al.*, 2001). Additionally, leptin promotes the secretion, but not expression, of the cytokine IL-18 by primary human monocytes (Jitprasertwong *et al.*, 2014). Jitprasertwong *et al.* (2014) found that this leptin-dependent effect on IL-18 processing required the activity of the intracellular protease caspase-1. Interestingly, leptin synergises with the Gram negative bacterial outer membrane molecule lipopolysaccharide (LPS) to enhance the expression of TNF- α by innate leukocytes (Shen *et al.*, 2005; Jaedicke *et al.*, 2013), which suggests that leptin could enhance inflammation in hyperleptinaemic populations.

Leptin has a direct role in DC priming in a way that favours a proinflammatory Th1 immune response (Fernandez-Riejos *et al.*, 2010), suggesting that leptin indirectly regulates adaptive immune responses. Several studies have shown that leptin promotes lymphocyte proliferation, activation and function in a subset-specific manner (Martin-Romero *et al.*, 2000; Farooqi *et al.*, 2002; Papathanassoglou *et al.*, 2006; Saucillo *et al.*, 2014). For example, leptin positively regulates the growth and survival of CD4+ T cells and B cells, but has no similar effect on Treg cells (Fernandez-Riejos *et al.*, 2010). Leptin enhances T cell activation and polarises responses, which is consistent with the known activities of related cytokines (Sanchez-Margalet *et al.*, 2003). Overall, these studies support a widespread potential of leptin to modulate cells of both the innate and adaptive immune system, and suggest that leptin functions in immune homeostasis and enhance immune responses in hyperleptinaemia.

1.4.3 Leptin regulation of ECM remodelling

Leptin increases the expression and extracellular matrix (ECM)-degrading activity of matrix metalloproteinase (MMP)-2 by a murine cardiac muscle cell line in a p38 MAPK-dependent manner, while simultaneously reducing the mRNA expression of the MMP inhibitor tissue inhibitor of metalloproteinases (TIMP)-1 and increasing the production of collagen (Schram *et al.*, 2010). Leptin suppresses the production of the

collagenase MMP-1 by a HSC line (Cao *et al.*, 2007), but increases MMP expression in primary murine trophoblast cells (Schulz *et al.*, 2009). These studies suggest that leptin regulates ECM remodelling, however it appears that the effect of leptin on this function differs between cell types, and depends on which MMPs are studied.

A glioma cell line stimulated with leptin has an increased ability to migrate compared to unstimulated cells (Yeh *et al.*, 2009). Yeh *et al.* (2009) found that this ability depends on the collagenase MMP-13 and is regulated by p38 MAPK and NF- κ B. Similarly, primary rat cardiac fibroblasts have an enhanced ability to migrate across wounds, likely due to increased expression of membrane integral MMP-14 and increased MMP-2 activity after leptin stimulation (Schram *et al.*, 2011). These studies suggest that leptin promotes cell migration and invasion by promoting ECM degradation, in addition to regulating chemokine/chemokine receptor production. Schram *et al.* (2011) also showed that leptin increases actin polymerisation in these fibroblasts in a RhoA/Rho-associated protein kinase-dependent manner, suggesting that leptin also enhances cell motility by regulating intracellular motility equipment. Interestingly, leptin synergises with the proinflammatory cytokines IL-1 and TNF- α to increase MMP-1 and MMP-13 expression by human articular chondrocytes and to increase cartilage degradation (Hui *et al.*, 2012). In this study, the increased MMP mRNA expression detected required JAK/STAT, MAPK and PI3K signalling pathways. Additionally, Hui *et al.* (2012) showed that white adipose tissue from articular joint fat pads also drives cartilage degradation, and that this effect is in part due to leptin. This study supports a role for leptin in enhancing ECM degradation during inflammation in cartilage, and suggests that leptin may be mechanistically relevant to the positive clinical association between obesity and osteoarthritis (Grotle *et al.*, 2008). Overall, the current evidence supports a role for leptin in regulating tissue-resident cell-mediated ECM remodelling. Whether this is beneficial or deleterious may depend on the context of exposure to leptin. Further studies investigating the ability of leptin to promote ECM degradation by other tissue-resident cell types are warranted, particularly at those sites where deleterious ECM remodelling can occur during inflammation. Could leptin synergise with other inflammatory mediators to promote ECM degradation? Array-based investigations may help to identify the complete profile of ECM-degrading enzymes, inhibitors of these enzymes and ECM components that leptin regulates, while tissue-based or *in vivo* models may help to determine the functional ability of leptin to regulate ECM remodelling.

1.4.4 Leptin regulation of the vasculature and fibrosis

Leptin drives the proliferation and migration of both vascular smooth muscle cells (Shan *et al.*, 2008) and human umbilical vein endothelial cells (HUVECs) (Park *et al.*, 2001). Leptin stimulates vascular endothelial growth factor (VEGF) production in a mammary tumour cell line (Zhou *et al.*, 2011) and HSCs (Aleffi *et al.*, 2005). Leptin-stimulated HUVEC supernatants also have increased gelatinolytic MMP (MMP-2/MMP-9) activity (Park *et al.*, 2001). Park *et al.* (2001) also showed that leptin enhances the formation of capillary-like tubes by HUVECS, and promotes angiogenesis in the rat cornea angiogenesis model. These studies support a role for leptin in promoting angiogenesis, which may be relevant to wound healing in the resolution of inflammation. Administration of leptin in a mouse model of vascular injury increases the formation of a neointimal layer in the femoral artery (Shan *et al.*, 2008). The neointima is caused by proliferation of vascular smooth muscle cells and aids the healing of vascular injuries, but also narrows the blood vessel lumen which is a risk for vessel occlusion (Jeremy and Thomas, 2010). In a model of ischaemic stroke, *ob/ob* mice were more susceptible to permanent vascular occlusion than wild-type animals (Valerio *et al.*, 2009). Valerio *et al.* (2009) observed that the administration of leptin prior to the induction of stroke reduced the extent of neuronal damage observed. The conflicting findings presented in these studies could be due to the different models of injury used and the complex responses to leptin but, nonetheless, do support a role for leptin in regulating the wound healing response of the vasculature. The extent of CCl₄ or diet-induced liver fibrosis is reduced in *db/db* mice compared to wild-type animals, suggesting that leptin promotes fibrotic responses in these models (Aleffi *et al.*, 2005; Choi *et al.*, 2010).

1.4.5 In vivo studies of immunological functions of leptin

In starved mice, which therefore have reduced circulating leptin levels, administration of leptin restores immune function (Mantzoros *et al.*, 2011). Leptin administration in *ob/ob* mice protects against fatal Gram positive bacterial infections (Hsu *et al.*, 2007), supporting a role for leptin in immunocompetence. However, mice which lack leptin receptor signalling via STAT3 survive a similar infectious challenge better than wild-type controls (Gove *et al.*, 2009; Mancuso *et al.*, 2011), suggesting that leptin signalling through STAT3 enhances the fatality of infections. These studies appear to contradict each other but may just serve to highlight the complexity of leptin signalling *in vivo*. In humans, leptin replacement therapy in a child that expressed no leptin protein due to

genetic mutation increased the potential for their T cells to be activated *ex vivo* (Farooqi *et al.*, 2002). However, in a study of women who had low circulating concentrations of leptin due to starvation, the administration of recombinant leptin had no effect on the *in vitro* potential for T cell activity (Chan *et al.*, 2006). Additionally, high doses of recombinant leptin given to lean, obese and obese+diabetic humans had no effect on the production of inflammatory cytokines (Chan *et al.*, 2005). These studies support a role for leptin in regulating immunocompetence in individuals that are starving, but suggest that above a (possibly quite low) threshold of circulating leptin concentration that leptin no longer has the ability to modulate certain immune and inflammatory responses. This is consistent with the hypothesis that leptin receptor signalling can be saturated (Section 1.3) (Mantzoros *et al.*, 2011). However, *ob/ob* and *db/db* mice have lower amounts of auto-antibodies and reduced T cell proliferation compared to wild-type animals in the antigen-induced arthritis mouse model (Busso *et al.*, 2002). Similarly, *db/db* mice are protected from both colitis and hepatitis (Gove *et al.*, 2009). In this study, Gove *et al.* (2009) found that the expression of cytokines, but not disease severity, was regulated in a STAT3-dependent manner, suggesting that different arms of the leptin signalling pathways regulate diverse inflammatory and immune-related functions. Additionally, recombinant leptin accelerates auto-immune diabetes in the non-obese diabetic mouse model (Matarese *et al.*, 2002). These studies suggest that leptin enhances auto-immune diseases and pathogenic inflammatory conditions, at least in these models.

Leptin regulates numerous events relevant to inflammation, immunity and wound healing, affecting both leukocytes and tissue-resident cells. Both obesity and T2DM, where elevated circulating leptin levels are often observed, are associated with a low-grade, systemic chronic inflammatory state (Hotamisligil, 2006; Coppari and Bjorbaek, 2012). Therefore, leptin could be a molecular link underlying the associations between obesity, T2DM and diseases where excessive/chronic inflammation is implicated in the pathogenesis like periodontitis (Pischon *et al.*, 2007; Preshaw, 2008; Bullon *et al.*, 2009). Further studies of leptin action, alone or in an inflammatory setting, on cells and tissues relevant to these diseases would help to address this hypothesis, and determine whether leptin has a protective or pathogenic role.

1.5 The periodontium: structure and function

The periodontium is a collection of tissues in the oral cavity that function to support and protect the teeth. Nowhere else in the human body are mineralised tissues (the teeth) exposed to the external environment, essentially protruding through the epithelium. As

such, the bone, connective tissues and epithelium of the periodontium contain several distinctive features which make this anatomical region unique. (Bartold and Narayanan, 2006)

1.5.1 Alveolar bone and the periodontal ligament

The alveolar bone, an extension of the maxilla and mandible, comprises sockets holding teeth. A thin layer of connective tissue called the periodontal ligament (PDL) is found between the teeth roots and alveolar bone, which helps to support and protect both the teeth and bone from the forces that occur during mastication. Loss of integrity of the PDL and alveolar bone resorption compromise tooth function and can result in tooth loss. The PDL contains a dense ECM consisting predominantly of type I, III and V collagens which form fibres attaching the root cementum to the alveolar bone.

Fibroblasts are the predominant cell type in the PDL, but endothelial cells and neurons are also present. (Bartold and Narayanan, 2006)

PDL fibroblasts are thought to function in maintaining the integrity of the PDL by producing and remodelling ECM components (Beertsen *et al.*, 1997). *In vitro* studies using primary human PDL fibroblasts have demonstrated that these cells recognise and respond to numerous stimuli, including mechanical stimuli and immunological mediators (Xiang *et al.*, 2009; Um *et al.*, 2011; Zhu *et al.*, 2011; Du *et al.*, 2012). Stimulated PDL fibroblasts produce a range of molecules that function in ECM remodelling, as well as inflammatory responses (Jonsson *et al.*, 2011).

1.5.2 Gingival tissue

The alveolar bone is covered superficially by a mucosal tissue called the gingiva (Figure 1.3). Gingival tissue is composed of a connective tissue layer, also called the lamina propria, which is separated by a type IV collagen-containing basal lamina to an epithelial layer. The lamina propria is characterised by a dense type I and III collagen-rich ECM which, similar to the PDL, provides resistance against mechanical forces. Unlike most other mucosal tissues, the gingiva rarely contains a submucosal layer; instead collagen fibres within the lamina propria attach to the underlying alveolar bone directly. Tissue-resident immune cells (predominantly macrophages), endothelial cells, neurons and occasionally adipocytes are present in gingival connective tissue. (Bartold and Narayanan, 2006)

Similar to the PDL, the predominant cell type within gingival connective tissue is the fibroblast; their primary function is to produce and remodel ECM components (Bartold

and Narayanan, 2006).. Gingival fibroblasts, like PDL fibroblasts, respond to a wide-range of molecules by producing inflammatory mediators (Section 1.11). Several studies have performed comparisons of primary PDL and gingival fibroblasts *in vitro* and found differences in the type and extent of responses between the cells (Jonsson *et al.*, 2011). For example, after being stretched gingival fibroblasts and PDL fibroblasts express a different panel of integrins (Bolcato-Bellemin *et al.*, 2000); similarly, in comparison to PDL fibroblasts, gingival fibroblasts are generally more responsive in regulating ECM synthesis after treatment with an enamel matrix protein derivative which stimulates growth responses (Haase and Bartold, 2001). Interestingly, gingival fibroblasts, unlike PDL fibroblasts, increase the expression of TLR2 after stimulation with TLR2 agonists, which suggests that these cell types may respond to infection in different ways (Faria Morandini *et al.*, 2012).

The epithelium which covers the external surface of the gingiva consists of three distinct types based on location and structure, namely the gingival, sulcular and junctional epithelium. The gingival epithelium covers the external surfaces of the gingiva, from the muco-gingival border to the free gingival margin. The gingival epithelium is thick and keratinised, which helps to protect the gingiva from damage during mastication, and acts as an innate barrier against the invasion of oral microbes. The sulcular epithelium covers the gingiva from the free gingival margin into the gingival sulcus, essentially facing the crown of the tooth. Unlike gingival epithelium, sulcular epithelium tends not to be keratinised. The third type of epithelium in the gingiva is the junctional epithelium. Junctional epithelium is found at the base of the gingival sulcus between the sulcular epithelium and the tooth surface (at the cemento-enamel junction (CEJ) in health). It is a non-keratinised and thin epithelium. In fact, the junctional epithelium can be only a few cells thick. This structure helps to make the junctional epithelium fairly permeable, and in health there is an outward movement of fluid and cells. (Bartold and Narayanan, 2006)

1.5.3 Gingival crevicular fluid

The fluid secreted from the junctional epithelium makes up the gingival crevicular fluid (GCF), which is a serum and tissue exudate and contains molecules involved in host defence, namely complement, cytokines and antibodies. Additionally, the junctional epithelium appears to be the site of leukocyte egress into the gingival sulcus. This action may be directed by the production of chemokines by junctional epithelium cells. Most of the leukocytes found in GCF are neutrophils, but macrophages and lymphocytes have

also been detected. Although GCF contains molecules and cells of the innate and adaptive immune systems, the lack of a keratinised barrier in the gingival sulcus is a potential weakness available to exploit by oral microbes. (Delima and Van Dyke, 2003)

1.5.4 Host-microbe interactions in the periodontium

Over 500 species of microorganisms have been identified in dental plaque on the surfaces of the tooth and tooth root. Most of these microorganisms are commensals; several species are pathogenic. The attachment of early colonising bacteria to the teeth is the first step in the formation of mixed-species 'plaque' biofilms, which survive due to synergistic and cooperative relationships. (Darveau, 2010)

Initially, the biofilm forms on supra-gingival surfaces, which are sequestered from host cells by the mineralised or keratinised external barrier surfaces and superficial antimicrobial peptides (Delima and Van Dyke, 2003). However, if the supra-gingival biofilm is allowed to mature, through poor oral hygiene for example, it can extend to sub-gingival surfaces (the gingival sulcus) (Darveau, 2010). The sub-gingival biofilm contains different types of microorganisms compared to the supra-gingival biofilm; with a shift towards mostly anaerobic, gram negative, motile and potentially pathogenic species (Zijnge *et al.*, 2010). The high proliferative rate of gingival epithelial cells, and therefore the high turnover of the gingival epithelium, limits the extent of attachment, colonisation and invasion of microorganisms in the periodontium (Bartold and Narayanan, 2006). However, the lack of an innate physical barrier in the gingival sulcus leaves the epithelial cells and the underlying lamina propria exposed directly to microbes and their secreted products (Madianos *et al.*, 2005).

The expression of PRRs (e.g. TLRs, NLRs) is widespread in periodontal cells including resident and recruited leukocytes (Madianos *et al.*, 2005). TLR1 - TLR10 have been detected by IHC in human gingival tissue sections (Beklen *et al.*, 2008). LPS-stimulated gingival epithelial cells upregulate the production of proinflammatory cytokines (e.g. IL-1 β , IL-6), chemokines and MMPs (Kraus *et al.*, 2012). LPS from the periodontitis pathogen *Porphyromonas gingivalis* increases the production and activity of the gelatinases MMP-2 and MMP-9 in a gingival fibroblast and U937 macrophage co-culture model (Kuo *et al.*, 2012). Interestingly, LPS from *Escherichia coli* and *P. gingivalis* alters the gene expression patterns of THP-1 monocytes in similar and unique ways (Barksby *et al.*, 2009). Gingival fibroblasts also respond to TLR agonists (Section 1.11). Inflammatory responses in gingival cells are also driven through the recognition

of microbial metabolites (e.g. formylmethionine), or by the activation of protease-activated receptors by microbial proteases (Slots, 2005; Guo *et al.*, 2010). Therefore, cells found in the gingiva recognise and respond to a range of microbial stimuli (although LPS has been most studied), and this interaction is likely to play a role in the initiation and propagation of microbial-derived inflammation in the gingiva.

The acute inflammatory and immune responses generated by the sub-gingival biofilm are usually successful in inhibiting the invasion of microorganisms into the periodontium; however, these host defence mechanisms are unable to clear the biofilm (Darveau, 2010). Some of the species within the biofilm produce molecules that modulate the ability of the host to kill microbes (Madianos *et al.*, 2005). For example, poorly immunogenic polysaccharide capsules cover immunogenic epitopes, while bacterial-derived proteases degrade cytotoxic molecules such as complement (Delima and Van Dyke, 2003). Additionally, bacteria can regulate the activity of complement (Guo *et al.*, 2010). The binding of *P. gingivalis* to complement receptor 3 drives the production of damaging proinflammatory cytokines and chemokines, while reducing the production of the immunoregulatory cytokine IL-12 (Hajishengallis, 2010). *P. gingivalis* also promotes the cleavage of complement component C5 into C5a and C5b. *P. gingivalis* further degrades C5b thereby inhibiting cell lysis via the membrane attack complex, while levels of C5a accumulate which may paralyse neutrophil and macrophage function (Popadiak *et al.*, 2007). The large mass of the biofilm limits the extent to which it can be phagocytosed (Darveau, 2010). As such, neutrophils may be required to promote extracellular microbial killing, via the release of microbicidal molecules or neutrophil extracellular traps; these mechanisms of extracellular killing can further exacerbate the inflammatory response by promoting damage or death to periodontal cells and tissues (Vitkov *et al.*, 2009; Scott and Krauss, 2012).

1.6 Periodontitis

The inability of the host to clear the sub-gingival biofilm drives a chronic inflammatory response, known as gingivitis (Darveau, 2010). Gingivitis is characterised by swollen and painful gums that may bleed under probing; these clinical signs are caused by the actions of inflammatory mediators and cells in the gingiva. Over 50 % of the UK population have gingival bleeding (White *et al.*, 2011), but it is a reversible condition that can be ameliorated by the mechanical removal of the biofilm. However, if the sub-gingival biofilm is not removed, gingivitis can progress to an irreversible, destructive,

chronic inflammatory disease of the periodontium called periodontitis. (Chapple and Gilbert, 2002)

Periodontitis is characterised by the progressive destruction of gingival tissue and the underlying alveolar bone which results in reduced function, and eventually loss, of the teeth. The aetiological agent of periodontitis is the microbial biofilm that forms on periodontal surfaces. However, periodontitis is driven by the actions of tissue-degrading molecules and cells activated by the host immune and inflammatory responses. This destructive inflammatory state spreads throughout the periodontium, from the epithelia through the connective tissue, to the PDL and alveolar bone. (Darveau, 2010)

1.6.1 Clinical aspects of periodontitis

In the UK 45 % of dentate adults have evidence of current or historical periodontitis (pocket depths (PD) \geq 4 mm), while 8 % have moderate to severe disease (PD \geq 6 mm) (White *et al.*, 2011). Currently 10 % of the UK population has periodontitis, and this prevalence is increasing (White *et al.*, 2011). Interestingly, alveolar bone loss as observed in periodontitis is the most common osteopenia in humans (Liu *et al.*, 2010). Periodontitis presents as either an aggressive or chronic, local or generalised disease in both adults and children (Chapple and Gilbert, 2002). Chronic periodontitis is the most common form of the disease, and is positively associated with increased age (White *et al.*, 2011). Periodontitis has a complex pathogenesis and the severity of the disease depends upon microbial, immunologic, genetic and environmental factors that are not presently fully understood (Kornman, 2008).

The loss of alveolar bone, determined clinically by radiograph, is used to assist in the diagnosis of periodontitis; this resorption of the alveolar bone, and destruction of gingival ECM, causes recession of the gingiva (Chapple and Gilbert, 2002). Alveolar bone resorption coupled with the activation of epithelial cells, and the advancing plaque biofilm during periodontitis cause proliferation of the epithelium towards the root apex; this results in the loss of attachment of the junctional epithelium at the CEJ, destruction of the PDL, and potentially destabilisation of the tooth (Bartold and Narayanan, 2006). The loss of attachment and total depth of this periodontal 'pocket' are measured as part of the diagnostic periodontal examination (Chapple and Gilbert, 2002). At healthy sites, Chapple and Gilbert (2002) state that there should be no clinical attachment loss (CAL) and a PD of $<$ 3 mm. However, these definitions vary widely across the global periodontal research population.

Although periodontitis is a disease that has evolved with humans over 1000s of years we are yet to develop an effective treatment for the inflammation (Newman *et al.*, 2011). Current preventative strategies involve implementing good oral hygiene practise to minimise the build-up of the periodontal plaque biofilm (Chadwick *et al.*, 2011). One routine treatment option is surgical debridement of the gingiva to reduce the depth of the periodontal pocket (flap surgery) and therefore, to reduce the area available for the sub-gingival biofilm to advance (Heitz-Mayfield *et al.*, 2002). The gold standard treatment for periodontitis is the mechanical removal of the sub-gingival biofilm by root surface instrumentation (RSI) (Heasman *et al.*, 2004). Only one host-modulating therapeutic has been licensed for use in Europe and the USA, namely sub-antimicrobial dose doxycycline (SDD) which has a potent MMP-inhibiting activity at doses that are not toxic to bacteria (Preshaw, 2008). Several clinical trials have shown that SDD improves the clinical outcome of periodontitis when used as an adjunct to RSI (Lee *et al.*, 2004a; Lee *et al.*, 2004b; Preshaw *et al.*, 2004). While these treatments can stabilise active disease, the loss of alveolar bone in particular is irreversible and these treatments are time-consuming and expensive (Preshaw, 2008). Therefore, there is a need to better understand the pathogenesis of periodontitis to identify novel therapeutic targets, and to better understand which individuals are at risk of developing periodontitis.

1.6.2 The pathogenesis of periodontitis

Several bacterial species (*P. gingivalis*, *Aggregatibacter actinomycetemcomitans*, *Tannerella forsythia*, *Treponema denticola*, *Fusobacterium nucleatum*) are isolated more frequently from sites of periodontitis compared to health (Darveau, 2010). These species adhere to Sokransky's criteria as microbial causes of periodontitis (Socransky, 1979). Pathogenic strains of these species, and/or those that utilise virulence factors, are more likely to evade host defences, to invade host cells and disrupt tissue integrity (Madianos *et al.*, 2005). Several bacterial species, but most notably *P. gingivalis*, produce proteases, which target both pro and anti-inflammatory host mediators (Guo *et al.*, 2010). Additionally, there is *in vitro* evidence that bacterial-derived proteases activate MMPs (DeCarlo *et al.*, 1997), and may exacerbate host tissue destruction indirectly. Overall, this suggests that a change in the composition of the periodontal plaque biofilm plays a role in the pathogenesis of periodontitis.

Tissue destruction during the pathogenesis of periodontitis is currently attributed to host immune and inflammatory mechanisms (Darveau, 2010). Many studies have shown that the concentration and activity of proteases (particularly MMPs) increase in periodontitis

(Section 1.9). However, it is not fully understood how these proteolytic enzymes, which are normally tightly controlled even in acute inflammation, are dysregulated in periodontitis (Section 1.10). Osteoclasts are the only known cell with the ability to demineralise bone, and are therefore implicated in the pathogenesis of periodontitis; osteoclast development and activation are promoted by receptor activator of NF- κ B ligand (RANKL), macrophage-CSF and several cytokines (Liu *et al.*, 2010). Elevated levels of RANKL (and an elevated RANKL/osteoprotegerin (OPG) ratio) have been identified in the GCF and saliva of patients with periodontitis (Taubman *et al.*, 2007). Additionally, the inhibition of RANKL by OPG results in reduced alveolar bone loss in the ligature-induced periodontitis model in rats (Jin *et al.*, 2007), which is in support of increased osteoclast activity during periodontitis.

Numerous clinical studies (mostly cross-sectional) have identified associations between periodontitis and potential risk factors; these risks may be due to genetic, environmental, or behavioural factors; or due to the presence of concurrent systemic disorders (Kornman, 2008). For example, attempts have been made to identify associations between periodontitis and polymorphisms in cytokine (Taylor *et al.*, 2004) and MMP genes (Loo *et al.*, 2011). Overall, these genetic association studies present conflicting results and suggest that the impact of individual genetic polymorphisms on the risk of periodontitis are only small and relevant to particular populations. Similarly, there is some evidence that the presence of chronic viral infections in the periodontium may determine the risk of developing periodontitis (Slots, 2005). There is strong evidence that smoking is a behaviour that increases an individual's risk of developing periodontitis, and reduces the chance of effective therapy (Kornman, 2008). Cardiovascular disease, T2DM and obesity/overweight have all been positively associated with periodontitis (Section 1.7). Prospective clinical studies that could determine whether these risk factors are causal in the pathogenesis of periodontitis are lacking.

The pathogenesis of periodontitis is complex. The risk of developing periodontitis and the severity of disease varies between individuals, between sites within the same individual, and over time. However, the complex nature of the inflammatory and immune responses in humans means that the mechanisms underlying many of these clinical associations have not been fully explored.

1.7 Association of obesity and T2DM with periodontitis

Obesity and T2DM are associated with a systemic low-grade, chronic inflammatory state (Hotamisligil, 2006). As periodontitis is a chronic inflammatory disease (Darveau, 2010), it has been hypothesised that T2DM and obesity affect the pathogenesis of periodontitis (Preshaw *et al.*, 2012).

1.7.1 T2DM and periodontitis

Many clinical studies show that T2DM is positively associated with periodontitis (Preshaw *et al.*, 2012). However, in a small study by Davies *et al.* (2011), no significant differences were observed in a range of serum biomarkers relevant to diabetes (and obesity) in individuals with aggressive periodontitis compared to healthy controls, suggesting that the association between periodontitis and diabetes may depend on study design and the outcomes investigated. No strong associations have been found linking T2DM with changes in the plaque microbiota; instead, it is thought that elevated levels of systemic cytokines in T2DM promote periodontitis (Taylor *et al.*, 2013). Also implicated, are advanced glycation end-products (AGEs), which accumulate in the gingiva of periodontitis patients with poorly controlled T2DM (Zizzi *et al.*, 2012). The amount of AGEs found in the gingiva is associated with the length of time since the onset of T2DM, suggesting the duration of T2DM may determine the risk of developing periodontitis. AGEs reduce collagen production and increase MMP production by gingival fibroblasts, suggesting that AGEs may promote gingival tissue degradation in individuals with T2DM and supporting a mechanistic role for fibroblasts in the association between T2DM and periodontitis (Ren *et al.*, 2009; Yu *et al.*, 2012). T2DM is associated with various bone diseases, and increased alveolar bone loss is observed in the diabetic (leptin receptor mutant) Zucker rat strain (Liu *et al.*, 2006). Interestingly, there is some evidence to suggest that treating periodontitis improves T2DM, possibly by reducing systemic levels of pro-inflammatory cytokines, and indicates a bidirectional relationship exists between these diseases (Taylor *et al.*, 2013). Although a positive clinical association between T2DM and periodontitis has been well demonstrated, the temporal and mechanistic relationships between these two diseases are not yet understood.

1.7.2 Obesity and periodontitis

A relationship between obesity and periodontitis has been hypothesised since at least the 1970s when it was shown that the pathology of periodontitis was more severe in the Zucker (leptin receptor mutant) rat strain (Perlstein and Bissada, 1977). Since then

many clinical studies have investigated the link between obesity/overweight and periodontitis (Pischon *et al.*, 2007). A recent systematic review and meta-analysis of the available literature on obesity/overweight and periodontitis has been performed (Suvan *et al.*, 2011). Suvan *et al.* (2011) found that most of the clinical studies used a cross-sectional design with only a few case/control or cohort approaches so the evidence available was of fairly low quality. Overall, this meta-analysis found that overweight/obese individuals have an odds ratio (OR) of 2.1 for having periodontitis (Suvan *et al.*, 2011). Additionally, Suvan *et al.* (2011) found that periodontitis was still significantly positively associated with overweight (OR 1.3) and obese (OR 1.8) categories individually; it was significant that the OR for obesity was higher than that of overweight suggesting that the risk of periodontitis increases as weight increases. Since this meta-analysis Suvan *et al.* (2014) have published their own clinical study investigating how BMI affects the outcome of treatment for chronic periodontitis. They found that obese individuals have more severe periodontitis (as measured by PD, plaque index and bleeding index) than non-obese controls both before and after treatment. Additionally, the treatment outcomes were poorer in obese individuals compared to controls suggesting that obesity affects the success of treatment for periodontitis (Suvan *et al.*, 2014). Interestingly, they found that the poorer response to treatment in the obese group was comparable to that attributed to smoking, one of the risk factors most strongly linked to periodontitis (Kornman, 2008). Another recent study compared the outcomes of treatment for chronic periodontitis between obese and non-obese study groups (Altay *et al.*, 2013). Altay *et al.* (2013) found that while treatment improved periodontitis and reduced systemic levels of IL-6 in both groups, these changes were not significant between the obese and non-obese groups. However, they found that systemic levels of TNF- α , leptin and insulin resistance were reduced only in the obese group. It would have been interesting to see how the measures of periodontitis and obesity compared to controls (non-obese and obese) with no periodontitis; unfortunately these groups were not investigated in this study.

Clinical interventional studies investigating any effects obesity has on periodontitis may be difficult to manage, given the complex nature of obesity and the difficulty in controlling food intake across a study population. Therefore, *in vivo* models have been utilised instead (Pischon *et al.*, 2007). Using the ligature-induced periodontitis model in rhesus macaques, Branch-Mays *et al.* (2008) found that the severity and progression of periodontitis (as measured by gingival index, bleeding on probing (BOP), PD and CAL)

is reduced in animals that have a 30 % calorie-restricted diet compared to normal diet control. This study suggests that nutritional intake determines the risk of developing periodontitis, although whether this is translatable to humans is unknown. Additionally, it would have been interesting to see if the severity and progression of periodontitis was increased in animals that were overfed. This approach was taken, to some extent, by Bendyk *et al.* (2009) in the bacteria-induced periodontitis model in mice. In this study mice were fed either an ω 3-polyunsaturated fatty acid (PUFA) oil-rich diet or a control oil-rich diet. The animals that received the ω 3-PUFA diet had reduced alveolar bone loss compared to the control oil-rich diet (Bendyk *et al.*, 2009). This could have been due to the increased synthesis of anti-inflammatory lipid mediators such as lipoxins, which reduce bone loss in periodontitis (Serhan *et al.*, 2003). However, this study lacked a normal chow diet-fed control which would have been a useful comparison.

T2DM and obesity are positively associated with periodontitis (Pischon *et al.*, 2007; Taylor *et al.*, 2013). However, the results to date show some variation. This is probably due to the complicated natures of T2DM, obesity and periodontitis, the various ways to measure the severity of these conditions, and the variety of questions addressed in the studies. The mainly cross-sectional design of the clinical studies means there is a lack of information on the temporal relationship between obesity, T2DM and periodontitis. While most of the studies have adjusted for some potentially confounding factors, such as age, gender, oral hygiene status and smoking, it is possible that other masked confounding factors may be behind these associations. Questions that are still currently unanswered are do obesity or T2DM promote periodontitis or vice versa; and if one condition does exacerbate the others are disease initiation, severity, progression and/or outcome affected? The identification of molecules that may be mechanistically relevant to these clinical associations, such as adipokines, may help to address these questions.

1.8 Association of leptin with periodontitis

Circulating levels of the adipokine leptin are elevated in obesity and T2DM (Section 1.3), and these conditions are positively associated with periodontitis (Section 1.7). Leptin functions as a cytokine and can promote inflammation and ECM remodelling (Section 1.4), which are functions relevant to the pathogenesis of periodontitis. In this thesis it is hypothesised that leptin could be a molecular link mechanistically underlying the associations between obesity, T2DM and periodontitis.

1.8.1 Clinical associations between leptin and periodontitis

Several clinical studies have investigated whether leptin concentrations correlate with periodontitis disease severity (Johnson and Serio, 2001; Bozkurt *et al.*, 2006; Karthikeyan and Pradeep, 2007a; Karthikeyan and Pradeep, 2007b; Gangadhar *et al.*, 2011; Ramesh *et al.*, 2011; Yetkin Ay *et al.*, 2011; Gundala *et al.*, 2012). Study approaches were generally cross-sectional and assessed leptin concentrations in serum, GCF or gingival tissue homogenates from individuals that had varying severities of periodontitis. Most of these studies report that leptin concentrations are lower in GCF and gingival tissue, but higher in serum as the severity of periodontitis progresses (Johnson and Serio, 2001; Karthikeyan and Pradeep, 2007a; Karthikeyan and Pradeep, 2007b; Gangadhar *et al.*, 2011). Unfortunately, most of these studies are of a poor quality. For example, none of these studies presented gender or BMI data for study groups (or where presented these demographics were significantly different between groups) (Johnson and Serio, 2001; Bozkurt *et al.*, 2006; Karthikeyan and Pradeep, 2007a; Karthikeyan and Pradeep, 2007b; Gangadhar *et al.*, 2011; Ramesh *et al.*, 2011; Yetkin Ay *et al.*, 2011; Gundala *et al.*, 2012). Both gender and BMI are highly positively associated with leptin concentration, and therefore, the observed changes may be due to these factors and not periodontitis (Maffei *et al.*, 1995; Considine *et al.*, 1996). Other studies fail to comprehensively describe the statistical approach used for making comparisons between groups (Bozkurt *et al.*, 2006; Karthikeyan and Pradeep, 2007a; Ramesh *et al.*, 2011; Gundala *et al.*, 2012). In yet other studies, the measurement of leptin from very small volumes of GCF, albeit using sensitive antibody-based techniques, seems implausible (Bozkurt *et al.*, 2006; Karthikeyan and Pradeep, 2007b).

In a study where the results were adjusted for gender and BMI no difference was identified in the serum leptin concentration between individuals who had aggressive periodontitis compared to healthy controls (Davies *et al.*, 2011). However, Davies *et al.* (2011) found that serum leptin concentrations were significantly higher in women compared to men. Similarly, a well-designed study by Teles *et al.* (2009) found no difference in serum leptin concentrations across different periodontal PDs. In the individual study groups no significant differences in gender and BMI were found, but across the whole study population leptin concentrations correlated highly with gender and BMI (Teles *et al.*, 2009). In a study by Shimada *et al.* (2010), serum leptin concentrations were positively associated with chronic periodontitis (as measured by PD, CAL and alveolar bone loss) compared with controls with similar BMI and gender.

Additionally, after non-surgical treatment for periodontitis serum leptin concentrations were reduced, but were still significantly higher than healthy controls (Shimada *et al.*, 2010). Another study investigated leptin concentrations in four different groups (chronic periodontitis, chronic periodontitis and obese, obese, healthy) (Zimmermann *et al.*, 2013). They found increased serum levels of leptin in the chronic periodontitis and/or obesity groups compared to healthy controls. Overall, the poor quality of many studies investigating leptin and periodontitis and the conflicting results of the better quality studies, mean that an association between leptin and periodontitis (let alone a mechanistic link) has yet to be established.

1.8.2 Leptin in the periodontium

Several studies have used IHC to show that leptin and the leptin receptor are present in gingival tissues from humans (Ay *et al.*, 2012), rats (Ide *et al.*, 2011) and macaques (Li *et al.*, 2014). Additionally, both leptin and the leptin receptor are present in human gingival tissue from healthy, gingivitis and periodontitis sites (Ay *et al.*, 2012). Leptin has also been detected by enzyme-linked immunosorbant assay (ELISA) in gingival papillae, and the amount of tissue leptin decreased as the severity of periodontitis (characterised by PD and BOP) increased (Johnson and Serio, 2001). However, gender and BMI data were not presented by study group, which limits the conclusions that can be drawn from this study.

Leptin receptor is widely expressed in the gingiva, while leptin expression seems more limited to epithelial and endothelial cells (Li *et al.*, 2014). *In vitro* studies have shown that THP-1-derived macrophages and human gingival fibroblasts (hGFs) express the long isoform of the leptin receptor (Kim, 2010; Park *et al.*, 2013). These studies suggest that leptin is found in the periodontium and that resident cells respond to leptin. One question that remains is whether the source of periodontal leptin is local or systemic? It is likely that serum leptin leaches from the vasculature into the periodontal tissues, particularly during inflammation. Ectopic adipose tissue in close proximity to the periodontium (e.g. the bone marrow of the maxilla or mandible), or adipocytes and other leptin-producing cells in the periodontium could be local sources of leptin (Mantzoros *et al.*, 2011).

Leptin treatment of stem cells isolated from the PDL results in decreased expression of the leptin receptor, increased alkaline phosphatase activity and a reduced potential for adipogenesis (Um *et al.*, 2011). This suggests that leptin regulates periodontal cell

function. Interestingly, leptin synergises with LPS from the putative periodontal pathogen *Prevotella intermedia* to increase TNF- α secretion in THP-1-derived macrophages, while leptin alone increases CXCL8 production (Kim, 2010). This suggests that leptin may enhance inflammatory responses in the periodontium. There is little other information known regarding the possible functions of leptin in the periodontium, or in the pathogenesis of periodontitis (except for one study in hGFs (Section 1.11.6)).

1.9 The role of MMPs in periodontitis

MMPs are a family of zinc-dependent endopeptidases that together can degrade all components of the demineralised ECM (Nagase *et al.*, 2006). Therefore, MMPs are implicated in the pathogenesis of diseases where deleterious tissue remodelling occurs, including arthritis (Burrage *et al.*, 2006), and periodontitis (Birkedal-Hansen, 1993). The identification of MMP functions *in vivo* has been hampered by evidence (e.g. using MMP knockout mouse models) that there is functional redundancy and compensation between MMPs. Functional redundancy means that multiple MMPs can perform the same function. For example, knockout of single MMPs in mice results in normal, or eventually normal, development; however, development in double MMP knockouts is more severely affected and can be lethal (Oh *et al.*, 2004; Stickens *et al.*, 2004). Similarly, in single MMP knockout mice but not wild-type controls, the expression of other MMPs increases after myocardial infarction or during uterine involution postpartum (Rudolph-Owen *et al.*, 1997; Ducharme *et al.*, 2000), which supports functional compensation between MMPs. Interestingly, several studies have now reported non-redundant functions of MMPs in models of inflammation (Page-McCaw *et al.*, 2007).

1.9.1 MMP structure and function

MMPs are grouped by substrate specificity and were originally named likewise. However, after the discovery of further members of the MMP family through sequence and structural bioinformatics searches of the human genome, and the discovery that MMPs have overlapping substrate specificities, MMPs were renamed numerically (Table 1.1). Mammalian MMPs are highly homologous, share the same basic structure and all contain a propeptide region and catalytic domain. The catalytic domain contains the active site in which a Zn²⁺ ion is bound. The active site is well conserved between MMPs, and this similarity could be the reason why MMP inhibitors that targeted the active site caused wide-spread adverse events in clinical trials (Peterson, 2006; Murphy

and Nagase, 2008). The catalytic site of the gelatinases contains fibronectin type II repeats, which facilitate binding to collagen. The propeptide region regulates MMP activity; a highly conserved cysteine residue in the propeptide region interacts with the Zn^{2+} ion in the active site, subsequently preventing MMP activity. The proteolytic cleavage of the prodomain disrupts the interaction between the conserved cysteine and Zn^{2+} ion, promoting MMP activity. This activatory step is known as the 'cysteine switch'. The initial proteolytic cleavage of the prodomain requires exogenous protease activity; subsequent activatory cleavage steps can occur auto-lytically. Interestingly, the interaction between the conserved cysteine and Zn^{2+} ion can also be destabilised chemically, by reactive oxygen species (ROS) for example (Hannas *et al.*, 2007). ROS-mediated MMP activation may be relevant to MMP activity in periodontitis as levels of lipid peroxidation (a marker of ROS) are elevated in the circulation of individuals with periodontitis compared to controls (Dahiya *et al.*, 2013). It is currently thought that the haemopexin or regulatory domain, which is linked to the catalytic domain by a hinge region and is found in all mammalian MMPs except the matrilysins, determines MMP substrate specificity by facilitating protein-protein interactions. (Nagase *et al.*, 2006; Page-McCaw *et al.*, 2007)

MMPs are grouped into six main categories: collagenases, gelatinases, stromelysins, membrane-type MMPs, matrilysins and others (Table 1.1). Collagenolytic MMPs (MMP-1, MMP-8, and MMP-13) are the only known enzymes that can initiate the degradation of fibrillar collagens, resulting in the characteristic 1/4 and 3/4 collagen fragments. As a number of other MMPs further degrade collagen fragments, the initial cleavage step is thought to be critical in the regulation of collagen degradation. As fibrillar collagens are the predominant ECM component in the periodontal connective tissues, collagenase activity is implicated in periodontitis (Hannas *et al.*, 2007). The gelatinases (MMP-2, MMP-9) have broad substrate specificity but are characterised for their degradation of partially hydrolysed fibrillar collagen (gelatin) and type IV collagen (which is found in periodontal basement membranes). The stromelysins (MMP-3, MMP-10, and MMP-11) and matrilysins (MMP-7, MMP-26) have a broad range of substrate specificities, similar to the gelatinases. The membrane-type MMPs (MMP-14 - MMP-17, MMP-24, and MMP-25) also have broad substrate specificity but differ to other MMPs by remaining in association with the cell membrane instead of being secreted. Four of the membrane-type MMPs (MMP-14 - MMP-16, MMP-24) are

transmembrane proteins, while MMP-17 and MMP-25 are associated with the membrane by a glycosylphosphatidylinositol-anchor. (Nagase *et al.*, 2006)

1.9.2 MMPs are associated with periodontitis

Numerous studies have detected MMPs in the oral cavity and MMPs are usually found to be elevated in periodontitis compared to healthy controls (Hannas *et al.*, 2007). MMPs can be detected in saliva; these MMPs are generally derived from GCF, and therefore from the gingival tissue (Makela *et al.*, 1994). Several studies have found an increase in GCF MMP-8 and MMP-13 in periodontitis samples compared to controls (Kiili *et al.*, 2002; Lee *et al.*, 2004a; Pozo *et al.*, 2005). Using IHC, Kiili *et al.* (2002) found that MMP-8 is predominantly associated with neutrophils, epithelial cells and plasma cells in gingival tissue, and GCF MMP-8 is presumed to be neutrophil-derived. This correlates with the extra-gingival location of neutrophils during periodontitis (Delima and Van Dyke, 2003). However, a less glycosylated form of MMP-8 is secreted by gingival tissue resident cells (Kiili *et al.*, 2002), and the levels of tissue-MMP-8 may not have been taken into account in studies using ELISA instead of electrophoresis-based detection techniques. Routine mechanical treatment for periodontitis reduces the concentration of active MMP-8 in the GCF (Kiili *et al.*, 2002; Pozo *et al.*, 2005). Additionally, studies showing elevated GCF MMP-8 have taken samples from individuals with chronic periodontitis (Kiili *et al.*, 2002; Lee *et al.*, 2004a), while in juvenile periodontitis there is evidence that MMP-1 predominates in the GCF (Uitto *et al.*, 2003). In a study by Soell *et al.* (2002) the proportions of inactive and active MMPs (MMP-1/MMP-2/MMP-3/MMP-9) were the same in GCF samples from periodontitis compared to health, suggesting that the absolute levels of MMP may be increased in periodontitis instead of the conversion rate of inactive to active MMP. Overall, these studies have led to the trial of GCF/salivary MMPs (and MMP-8 in particular) as diagnostic and prognostic biomarkers for periodontitis (Sorsa *et al.*, 2006). However, there are limitations with measuring MMPs in GCF. For example, the small volumes of GCF acquired per site make measuring quantitative differences in MMP levels difficult. Additionally, levels of GCF MMPs vary between sites and between individuals.

IHC analyses have shown that MMP-2, but only low levels of other MMPs, are found throughout the healthy gingiva (Birkedal-Hansen, 1993; Segulier *et al.*, 2001; Kiili *et al.*, 2002; Dong *et al.*, 2009). Gingival tissue levels of MMP-1, MMP-2, MMP-3, MMP-8 and MMP-13 are elevated in periodontitis (Segulier *et al.*, 2001; Dong *et al.*, 2009).

MMP-8 and MMP-9 localise to neutrophils and epithelial cells, while MMP-1 localises to the epithelium and the sites of leukocyte infiltration (where both leukocytes and fibroblasts stain positively) (Dong *et al.*, 2009). While these studies do support the increased presence of MMPs in periodontitis, it is unclear whether gingival or GCF MMPs are mechanistically relevant to disease activity or outcome. Additionally, the measurement of MMPs by IHC is fairly subjective, and therefore, differences in MMP levels and their cellular sources throughout the gingiva have been reported between studies.

1.9.3 MMPs in the pathogenesis of periodontitis

The results of studies investigating the use of SDD as an adjunct therapy for periodontitis directly supports a functional role for MMPs in the pathogenesis of periodontitis (Preshaw, 2008). Doxycycline is a member of the tetracycline family of antibiotics, and members of this family have the ability to inhibit MMP activity (Preshaw *et al.*, 2004). This function is attributed to their ability to chelate zinc or to suppress ROS activity (Preshaw, 2008). Doxycycline was chosen as it inhibits MMP-8 more selectively than other MMPs, including MMP-1 (Preshaw *et al.*, 2004), and was therefore thought to be more relevant to periodontitis given the increased levels of MMP-8 observed in GCF (Kiili *et al.*, 2002; Pozo *et al.*, 2005). The addition of SDD to gold standard RSI treatment regimens for periodontitis results in a significantly larger reduction in PD, CAL and GCF MMP-8 and MMP-13 levels compared to gold standard treatment alone (Lee *et al.*, 2004a; Lee *et al.*, 2004b; Preshaw *et al.*, 2004). These studies suggest that MMPs (and in particular MMP-8) play a deleterious role in the pathogenesis of periodontitis.

There is increasing evidence to suggest that the degradation of ECM components by MMPs during inflammation is a key regulatory part of this physiological process. For example, cleavage of ECM components may assist in path clearing through tissues and epithelial migration (by disrupting intercellular adhesions and basement membranes). Similarly, fragments of ECM components and molecules bound to ECM components can be released by MMPs, and act as signalling molecules (Xu *et al.*, 2001). MMPs can proteolytically cleave inflammatory mediators, an action that depending on the substrate can drive molecular activation or degradation. Additionally, it is thought that controlled MMP activity may be important in scar-less wound healing, and may protect against bone destruction (Bjornsson *et al.*, 2004). (Page-McCaw *et al.*, 2007)

The actions of MMPs in inflammation are more complex than originally thought, and are unlikely to be entirely deleterious. Further investigations into the mechanisms that regulate excessive MMP production and activity in periodontitis and their functional relevance are required to improve our understanding of the role of these powerful enzymes in periodontitis, and how we might best target them to modulate the pathogenesis of periodontitis.

1.10 Mechanisms of MMP regulation during inflammation

MMPs are regulated at multiple levels (Page-McCaw *et al.*, 2007; Murphy and Nagase, 2008). Regulatory mechanisms exist at the level of the input stimuli and cell signalling, transcription, translation and secretion, activation, localisation and substrate specificity, inhibition and clearance (Page-McCaw *et al.*, 2007; Murphy and Nagase, 2008).

Disruption of any of these regulatory mechanisms could alter MMP-mediated tissue remodelling, and therefore many studies have investigated the regulation of MMPs in destructive chronic inflammatory diseases, such as periodontitis.

1.10.1 Stimuli that regulate MMP expression

Basal expression levels of most MMPs are low, but are greatly enhanced by particular stimuli (Murphy and Nagase, 2008). The lipid mediator prostaglandin (PG)E₂ (Ruwanpura *et al.*, 2004), LPS (Bodet *et al.*, 2007), immune cell microparticles (vesicles that are increasingly produced by immune cells during activation and apoptosis) (Distler *et al.*, 2005), ECM fragments (Fichter *et al.*, 2006) and pro-inflammatory cytokines (IL-1 α , IL-1 β , TNF- α , oncostatin M (OSM), IL-17) (Catterall *et al.*, 2001; Morgan *et al.*, 2006; Cortez *et al.*, 2007; Gosset *et al.*, 2010) all increase the production of MMPs in *in vitro* cell-based studies. For example, expression levels of MMP-3 by human synovial fibroblasts can be increased to 50-fold that of basal by IL-1 (MacNaul *et al.*, 1990; Birkedal-Hansen, 1993). Interestingly, *P. gingivalis* increases the production of gelatinases in an engineered human oral mucosa (EHOM) (Andrian *et al.*, 2004). Andrian *et al.* (2004) found that this activity was reduced in strains with mutations in proteases (called gingipains), suggesting that the production of gelatinases in this model required the presence of gingipains. Additionally, purified arginine gingipains increase MMP-1 production, although it is possible this was due to LPS contamination (Matsushita *et al.*, 2006). In contrast, other mediators such as transforming growth factor (TGF)- β and IFN- γ , suppress the production of MMPs (Birkedal-Hansen, 1993). The adipokine adiponectin, which is thought to have immunoregulatory potential, also regulates MMP production in synovial fibroblasts

(Kim *et al.*, 2010b) and human oral epithelial cells (Kraus *et al.*, 2012), although both increases and decreases have been described, and may be due to the different cell types studied. Trombone *et al.* (2009) found that periodontal levels of MMP-2 and MMP-13 (and osteoclastogenic mediators) are increased in mice that are prone to a strong acute inflammatory reaction (AIR) compared to controls in the *A. actinomycetemcomitans*-induced periodontitis model. In contrast, no differences in the management of the bacterial load between AIR and control mice were detected (Trombone *et al.*, 2009). This suggests that the regulation of ECM remodelling in periodontitis depends on the strength of the inflammatory response, and is regulated differently to the mechanisms that control infection. Overall, these studies illustrate that host and microbial-derived stimuli can increase the production of MMPs by cells found in the periodontium during inflammation.

1.10.2 Intracellular signalling pathways and transcription factors regulate MMP expression

The expression of most MMPs requires the transduction of extracellular stimuli via intracellular signalling pathways (Murphy and Nagase, 2008). The upregulation of MMP gene expression requires the immediate early synthesis of transcription factors (such as c-Fos and c-Jun which are activated by MAPK activity), which then bind to MMP promoters to enhance gene expression (Sorsa *et al.*, 2006). As such, increases in MMP production can take several hours to detect, but can remain upregulated for days (Birkedal-Hansen, 1993). This is in contrast to the expression of many inflammatory mediators which are induced within minutes and switched off again within hours (Barksby *et al.*, 2009). Binding sites for the transcription factor activator protein-1 (AP-1) (which is composed of c-Fos and c-Jun) are found in the promoters of many MMPs (MMP-1, MMP-3, MMP-7, MMP-9, MMP-10, MMP-12, MMP-13); STAT and NF- κ B binding sites are also found in many MMP promoters (Vincenti and Brinckerhoff, 2002). A combination of multiple transcription factors and enhancers on an MMP promoter helps to drive maximal gene expression (Cortez *et al.*, 2007). Indeed, combinations of stimuli synergistically increase the production and activity of MMPs by chondrocytes in cartilage (Catterall *et al.*, 2001; Koshy *et al.*, 2002; Morgan *et al.*, 2006), and human synovial fibroblasts (MacNaul *et al.*, 1990). Other combinations have an antagonistic relationship (Sukkar *et al.*, 2007). During inflammation it is likely that multiple signals are integrated via intracellular signalling pathways by resident and recruited cells to regulate MMP production in the connective tissue microenvironment.

A polymorphism in the promoter region of MMP-1 is associated with both aggressive and chronic periodontitis (de Souza *et al.*, 2003; Cao *et al.*, 2005). Bioinformatics analysis identified that this polymorphism introduces an additional binding site for the transcriptional enhancer Ets and may therefore promote MMP-1 expression (Sorsa *et al.*, 2006). Similar polymorphisms in MMP-3 and MMP-9 genes have been identified but they are less strongly associated with periodontitis (Loo *et al.*, 2011). Individuals that have these polymorphisms could be more likely to progress from gingivitis to periodontitis due to the potential for increased MMP expression.

1.10.3 Regulated secretion of MMPs

MMP secretion can be constitutive or regulated (Page-McCaw *et al.*, 2007). Of relevance to periodontitis, neutrophil MMP-8 is expressed and translated prior to cell activation and stored in intracellular granules; upon activation, MMP-8 containing granules are secreted extracellularly (Birkedal-Hansen, 1993). This makes sense as the innate immune response is required to activate within minutes; something that *de novo* expression of MMP-8 would hamper. Another level of MMP regulation relevant to neutrophils is that the cells have a short half-life (Scott and Krauss, 2012). Therefore, continued secretion of neutrophil-derived MMPs requires the infiltration of new neutrophils which will depend on local chemotactic gradients (Van Dyke and Serhan, 2003). Inflammatory stimuli may enhance MMP expression and secretion suggesting that MMPs drive inflammatory tissue remodelling, however the mere presence of MMPs does not result in proteolysis until the enzymes are activated (Sorsa *et al.*, 2006).

1.10.4 Activation of pro-MMPs

MMPs are synthesised as zymogens and require proteolytic cleavage of the prodomain to become active (Nagase *et al.*, 2006). Numerous host proteases activate MMPs, including MMPs themselves (Murphy and Nagase, 2008). For example, membrane bound MMP-14 activates MMP-2, which might help to localise MMP-2 activity in the pericellular region (Hannas *et al.*, 2007). Another MMP-activating protease, extracellular MMP inducer (EMPRIN) has been identified in the gingiva and may be produced by PDL cells, but whether levels of EMPRIN increase during periodontitis is not clear (Dong *et al.*, 2009; Xiang *et al.*, 2009). Perhaps the levels of MMP activators are less important than the concentrations of secreted MMP, although clearly once some MMP activity is established, there is the potential for a cascade of MMP-induced MMP activity. Interestingly, a *P. gingivalis* proteinase (presumably a gingipain) activates MMPs (DeCarlo *et al.*, 1997). DeCarlo *et al.* (1997) found that the *in vitro* incubation of

this *P. gingivalis* proteinase with MMP-3 and MMP-1 resulted in the production of superactive MMP-1 in only 1 minute; in contrast, MMP-3 activated MMP-1 but no superactive form was identified. Additionally, the *P. gingivalis* proteinase cleaved at a location distinct to the usual activatory or auto-catalytic sites (DeCarlo *et al.*, 1997). The extent to which this *in vitro* finding translates to MMP activation in the gingiva is unknown. However, it is possible that enhanced MMP activation by microbial-derived proteinases during periodontal inflammation plays a critical role in the tissue destruction observed in periodontitis.

1.10.5 Inhibitors of MMPs

Four TIMPs have been described in humans, and these MMP inhibitors non-covalently bind to both inactive and active forms of MMPs in a 1:1 ratio (Nagase *et al.*, 2006; Hannas *et al.*, 2007). All four TIMPs have been identified in periodontal tissues (Soell *et al.*, 2002; Pozo *et al.*, 2005; Andrian *et al.*, 2007; Nakasone *et al.*, 2009). TIMP-1 and TIMP-2 levels show some variation between periodontitis and health; however, the relationship between TIMP levels and periodontitis is unclear (Soell *et al.*, 2002; Pozo *et al.*, 2005). One of the key determinants for ECM degradation by MMPs is the ratio of MMPs to TIMPs or other inhibitors (Murphy and Nagase, 2008). Overall, current observations of MMPs and TIMPs in periodontitis indicate that the levels of MMP are enhanced while the levels of TIMPs stay fairly stable (Soell *et al.*, 2002; Pozo *et al.*, 2005; Andrian *et al.*, 2007), suggesting the MMP:TIMP ratio is increased in periodontitis and that MMPs play a role in periodontal tissue destruction. The protein α 2-macroglobulin (α 2M) is found in body fluids, including GCF and saliva, and covalently binds and inhibits MMPs (Birkedal-Hansen, 1993). Other MMP inhibitors have been described (Murphy and Nagase, 2008), and it is likely more will be identified in the future. MMP activity may also be controlled by the sequestration of MMPs in areas of ECM that do not contain their preferred substrates and by MMP degradation (Page-McCaw *et al.*, 2007).

Almost each level of MMP regulation is susceptible to alteration by molecules found in the inflamed periodontium. Increased concentrations and activities of MMPs are found in the periodontium during periodontitis (Hannas *et al.*, 2007), and MMPs are part of a select group of enzymes that can degrade demineralised periodontal ECMs (Nagase *et al.*, 2006). This suggests that excessive MMP activity is involved in the pathogenesis of periodontitis however, little direct evidence in support of this hypothesis is available. The inflammatory mechanisms of gingivitis and periodontitis are essentially the same.

Therefore the stimuli that promote MMP production are also present during non-destructive inflammation of the periodontium. What are the mechanistic cues that promote excessive MMP activity in periodontitis? Could a stronger inflammatory response be initiated in the periodontium of particular populations which enhances MMP production and activity? Leptin enhances MMP production, alone and in combination with inflammatory mediators (Section 1.4). Leptin is found in the periodontium, and both resident and recruited cells express the leptin receptor (Section 1.8). Circulating levels of leptin are elevated in obesity and T2DM (Section 1.3), and both of these conditions are positively associated with periodontitis (Section 1.7). In this thesis I hypothesise that leptin acts as a molecular link between obesity, T2DM and periodontitis by regulating the production of MMPs.

1.11 The role of gingival fibroblasts in inflammation and immunity

Cells with fibroblast morphology are the most numerous cell type in gingival connective tissue (Section 1.5) (Wikesjö and Selvig, 1999; Bartold and Narayanan, 2006). Gingival fibroblasts are mesenchymally-derived cells characterised by their ability to synthesise and remodel ECM components, their spindle-shaped morphology *in vitro*, and their lack of a consistent cell surface marker (McCulloch and Bordin, 1991; Lekic *et al.*, 1997; Kalluri and Zeisberg, 2006; Pilling *et al.*, 2009). Gingival fibroblasts recognise inflammatory changes in the gingival microenvironment, such as the presence of bacterial or white blood cells, or damage to the gingival ECM (Bartold *et al.*, 1992; Scragg *et al.*, 1999; Weinberg *et al.*, 2009). These cells, which are positioned in the centre of the complex gingival microenvironment, respond to inflammatory cues by regulating tissue remodelling, inflammatory and immune responses (Bartold and Narayanan, 2006). Due to these functions, and their predominance in gingival connective tissue, fibroblasts have been implicated in the pathogenesis of periodontitis.

Most studies that have investigated the functions of gingival fibroblasts have performed *in vitro* experiments on primary hGFs isolated in house, although primary hGFs are also available commercially (ATTC). The gingiva is a fairly accessible tissue, and several minimally invasive surgical procedures are routinely employed to acquire gingival or oral mucosal tissue for fibroblast isolation. Out of the studies that do report the procedure used to acquire gingival tissue, the most common source is waste tissue derived from tooth (particularly third molar) extractions. Gingival tissue is also acquired from tooth exposure surgery and gingivectomy procedures. One surgical approach in

the management of periodontitis is flap surgery. Gingival tissue acquired by flap surgery is also used to study fibroblasts derived from a site of periodontitis.

1.11.1 Regulation of ECM remodelling

Gingival fibroblasts are implicated in tissue remodelling during inflammation as they can synthesise ECM. The expression of ECM components by gingival fibroblasts, including type I and type III collagens and fibronectin, are regulated by growth factors and cytokines (Murakami *et al.*, 2001; Leivonen *et al.*, 2002; Palmqvist *et al.*, 2008; Ren *et al.*, 2009; Sume *et al.*, 2010; Arancibia *et al.*, 2012). For example, gingival fibroblasts stimulated with TGF- β or connective tissue growth factor increase collagen deposition in an integrin $\alpha 6\beta 1$ -dependent manner (Heng *et al.*, 2006). Interestingly, older fibroblasts produce less collagen (Varani, 2010) which could be mechanistically relevant to the increased risk of periodontitis with age (Huttner *et al.*, 2009).

Gingival fibroblasts may be able to remodel tissue by degrading ECM components during inflammation. During homeostasis, fibroblasts in the periodontium are thought to remodel ECM components (in particular type I collagen) by a highly controlled, pericellular and phagocytic pathway (Beertsen *et al.*, 1997). In gingival fibroblasts, this intracellular collagen-degrading activity is increased after exposure to LPS in a TLR4-dependent manner (Bhide *et al.*, 2005; Takahashi *et al.*, 2008), and when compromised, is implicated in the development of gingival fibrosis (McKleroy *et al.*, 2013). These studies suggest that homeostatic collagen turnover by gingival fibroblasts is modulated by inflammatory mediators. Interestingly, proinflammatory cytokines, bacterial TLR agonists, growth factors and PGE₂ regulate the production and secretion of ECM-degrading enzymes by gingival fibroblasts (Tervahartiala *et al.*, 2000; Yamada *et al.*, 2000; Dahan *et al.*, 2001; Domeij *et al.*, 2002; Leivonen *et al.*, 2002; Ruwanpura *et al.*, 2004; Beklen *et al.*, 2006; Cox *et al.*, 2006; Zhou and Windsor, 2006; Bodet *et al.*, 2007; Cury *et al.*, 2007; Zhou *et al.*, 2007; Smith *et al.*, 2009; Zhang *et al.*, 2011; Ujii *et al.*, 2012). The increased production of collagenolytic enzymes (MMP-1/MMP-8/MMP-13) by stimulated gingival fibroblasts has been extensively studied (Tervahartiala *et al.*, 2000; Yamada *et al.*, 2000; Domeij *et al.*, 2002; Leivonen *et al.*, 2002; Beklen *et al.*, 2006; Cox *et al.*, 2006; Zhou and Windsor, 2006; Cury *et al.*, 2007; Zhou *et al.*, 2007). In several studies this increase in collagenase production correlates to an enhanced ability of stimulated gingival fibroblasts to degrade type I collagen gels (Yamada *et al.*, 2000; Domeij *et al.*, 2002; Leivonen *et al.*, 2002; Cox *et al.*, 2006; Cury *et al.*, 2007; Zhou *et al.*, 2007), suggesting that the pro-MMPs secreted by gingival fibroblasts can

be activated. Gingival fibroblasts stimulated with proinflammatory mediators increase the production of other proteases (MMP-3/MMP-14/MMP-16/cathepsin B/cathepsin L/plasminogen activator) (Tervahartiala *et al.*, 2000; Dahan *et al.*, 2001; Domeij *et al.*, 2002; Ruwanpura *et al.*, 2004; Beklen *et al.*, 2006; Cox *et al.*, 2006; Zhou and Windsor, 2006; Bodet *et al.*, 2007; Cury *et al.*, 2007; Smith *et al.*, 2009; Ebisawa *et al.*, 2011). These other proteases degrade ECM components and activate pro-MMPs, thereby both directly and indirectly regulating ECM degradation. This MMP-activating function may be mechanistically relevant to the increased activity of gingival fibroblast-derived collagenases observed during inflammatory conditions. In addition, the activation of gingival fibroblast-derived proteases *in vivo* may be performed by enzymes derived from other sources, including neutrophils or *P. gingivalis* (Grayson *et al.*, 2003; Andrian *et al.*, 2004; Beklen *et al.*, 2006). Increased activities of the gelatinolytic MMPs (MMP-2/MMP-9) have also been detected in the supernatants of gingival fibroblasts stimulated with proinflammatory mediators (Dahan *et al.*, 2001; Arris *et al.*, 2003; Beklen *et al.*, 2006; Cox *et al.*, 2006; Zhou and Windsor, 2006; Bodet *et al.*, 2007; Cury *et al.*, 2007; Zhou *et al.*, 2007; Zhang *et al.*, 2011). Increased levels of MMPs and other proteases have been observed in inflamed gingiva by IHC, and in fibroblasts isolated from inflamed gingival tissue (Tervahartiala *et al.*, 2000; Cox *et al.*, 2006; Cury *et al.*, 2007). Overall, these studies suggest that during inflammatory conditions gingival fibroblasts increase the secretion and activity of MMPs and other proteases, which implicates gingival fibroblasts in tissue degradation during the pathogenesis of periodontitis.

Gingival fibroblasts express several protease inhibitors (TIMP1-4/ α 2M/plasminogen activator inhibitor-1 (PAI-1)) supporting the notion that gingival fibroblasts inhibit local tissue remodelling (Condacci *et al.*, 1988; Yamada *et al.*, 2000; Leivonen *et al.*, 2002; Arris *et al.*, 2003; Zhou and Windsor, 2006; Bodet *et al.*, 2007; Cury *et al.*, 2007; Nakasone *et al.*, 2009). For example, LPS and TGF- β increase the production of TIMP-1 and PAI-1 by gingival fibroblasts respectively. Additionally, gingival fibroblasts stimulated with LPS or PGE₂ increase the production of OPG at levels that inhibit the development of osteoclasts from monocytes (Nagasawa *et al.*, 2002; Kiji *et al.*, 2007). However, gingival fibroblasts are also stimulated by growth factors to produce RANKL which promotes osteoclastogenesis. These studies suggest that gingival fibroblasts regulate alveolar bone remodelling, as well as tissue remodelling in the gingiva. While

gingival fibroblasts clearly have the potential to remodel gingival ECM, whether this is beneficial or deleterious in the context of gingivitis and periodontitis is unknown.

1.11.2 Innate recognition of microbes

Gingival fibroblasts recognise and respond to TLR agonists. Gingival fibroblasts express up to nine TLRs, including TLR2 and TLR4, which suggests that these cells recognise microbe-associated molecular patterns in the gingiva (Kiji *et al.*, 2007; Mahanonda *et al.*, 2007; Uehara and Takada, 2007). Interestingly, TNF- α , TLR2 agonists and bradykinin upregulate the surface levels of TLR2 on gingival fibroblasts (Gutiérrez-Venegas and Arreguín-Cano, 2011; Davanian *et al.*, 2012; Faria Morandini *et al.*, 2012). This function is antagonised by anti-inflammatory prostaglandins (Davanian *et al.*, 2012), and suggests that the ability of gingival fibroblasts to recognise TLR2 agonists depends on which inflammatory mediators are present in the gingiva. Gingival fibroblasts stimulated with LPS also increase the secretion of high mobility group box-1 (HMGB1), independently of cell death (Feghali *et al.*, 2009). HMGB1 can act as an endogenous TLR4 agonist, suggesting that gingival fibroblasts may initiate TLR4 signalling in TLR4-expressing cells. In response to stimulation with TLR agonists, gingival fibroblasts increase the production of several CSFs (Costa-Rodrigues and Fernandes, 2011; Khaled *et al.*, 2013), which may drive increased production of leukocytes in the bone marrow. Levels of granulocyte-macrophage CSF in the gingival crevice are associated with generalised aggressive periodontitis (de Lima Oliveira *et al.*, 2012), although this was unlikely to be derived entirely from fibroblasts.

1.11.3 Regulation of leukocyte recruitment

Fibroblasts may be a source of chemokines in the gingiva. Aside from a potential role in increasing the number of circulating lymphocytes, gingival fibroblasts secrete numerous chemokines (CCL2, CCL3, CCL4, CCL5, CCL7, CCL8, CCL17, CXCL8, CXCL9, CXCL10, CXCL11, CXCL12) that together are responsible for the recruitment of most types of circulating leukocytes (Imatani *et al.*, 2001; Ozawa *et al.*, 2003; Brunius *et al.*, 2005; Mahanonda *et al.*, 2007; Minami *et al.*, 2007; Uehara and Takada, 2007; Hosokawa *et al.*, 2008; Mahanonda *et al.*, 2008; Hosokawa *et al.*, 2009; Morandini *et al.*, 2009; Dzierzewicz *et al.*, 2010; Hosokawa *et al.*, 2010a; Hosokawa *et al.*, 2010b; Montreekachon *et al.*, 2011; Morandini *et al.*, 2012; Khaled *et al.*, 2013). For example, increased production of CXCL8 by stimulated gingival fibroblasts may assist in the recruitment of neutrophils into the gingiva (Imatani *et al.*, 2001; Ozawa *et al.*, 2003; Brunius *et al.*, 2005; Mahanonda *et al.*, 2007; Minami *et al.*, 2007; Uehara and Takada,

2007; Mahanonda *et al.*, 2008; Dzierzewicz *et al.*, 2010; Montreekachon *et al.*, 2011; Khaled *et al.*, 2013). The production of chemokines by gingival fibroblasts is regulated by bacterially derived TLR agonists and inflammatory/immune response mediators; some of these stimuli synergise to further enhance chemokine secretion (Imatani *et al.*, 2001; Ozawa *et al.*, 2003; Brunius *et al.*, 2005; Mahanonda *et al.*, 2007; Minami *et al.*, 2007; Uehara and Takada, 2007; Hosokawa *et al.*, 2008; Mahanonda *et al.*, 2008; Hosokawa *et al.*, 2009; Morandini *et al.*, 2009; Dzierzewicz *et al.*, 2010; Hosokawa *et al.*, 2010a; Hosokawa *et al.*, 2010b; Montreekachon *et al.*, 2011; Morandini *et al.*, 2012; Khaled *et al.*, 2013). However, other resident or recruited cell types may also affect chemotaxis in the gingiva, so the importance of gingival fibroblasts in leukocyte recruitment *in vivo* has not yet been confirmed. Interestingly, cytokine stimulation of gingival fibroblasts synergistically increases surface intercellular adhesion molecule-1 expression, which increases neutrophil binding *in vitro* (Ozawa *et al.*, 2003; Mahanonda *et al.*, 2008; Hosokawa *et al.*, 2010a). This suggests that as well as recruiting lymphocytes, gingival fibroblasts are also able to promote retention of these cells within the gingiva. Dermal and synovial fibroblasts regulate the ability of endothelial cells to bind lymphocytes (McGettrick *et al.*, 2009), but whether gingival fibroblasts perform the same function has not been established.

1.11.4 Regulation of inflammation and immune responses

Gingival fibroblasts may be a source of proinflammatory cytokines and PGE₂ in the gingiva (Imatani *et al.*, 2001; Coletta *et al.*, 2002; Noguchi *et al.*, 2002; Ohshima *et al.*, 2002; Uehara *et al.*, 2005; Kiji *et al.*, 2007; Mahanonda *et al.*, 2007; Uehara and Takada, 2007; Botero *et al.*, 2008; Mahanonda *et al.*, 2008; Palmqvist *et al.*, 2008; Ara *et al.*, 2009; Feghali *et al.*, 2009; Chotjumlong *et al.*, 2010; Dzierzewicz *et al.*, 2010; Souza *et al.*, 2010; Båge *et al.*, 2011; Belibasakis and Guggenheim, 2011; Bostanci *et al.*, 2011; Zhu *et al.*, 2011; Belibasakis *et al.*, 2013; Khaled *et al.*, 2013). Although highly responsive to proinflammatory cytokines within the IL-1 and TNF families gingival fibroblasts secrete these cytokines only at low levels, even though increased mRNA expression is induced by microbial stimuli (Botero *et al.*, 2008; Bostanci *et al.*, 2011; Belibasakis *et al.*, 2013; Khaled *et al.*, 2013). However, gingival fibroblasts are a source of the proinflammatory cytokine IL-6, and production is often synergistically regulated by IL-1, TNF- α , lipid mediators and bacterial stimuli (Imatani *et al.*, 2001; Coletta *et al.*, 2002; Noguchi *et al.*, 2002; Uehara and Takada, 2007; Palmqvist *et al.*, 2008; Ara *et al.*, 2009; Dzierzewicz *et al.*, 2010; Belibasakis and Guggenheim, 2011;

Khaled *et al.*, 2013). Other IL-6 family cytokines, LIF and IL-11, are regulated in a similar manner (Palmqvist *et al.*, 2008; Souza *et al.*, 2010). Given the well-described functionality of the IL-6 family cytokines (Taga and Kishimoto, 1997b), these studies suggest that gingival fibroblasts drive wide-ranging inflammatory responses both locally and systemically. Additionally, gingival fibroblasts are a source of PGE₂, which is increased after stimulation with bacterial TLR agonists, IL-1 β /TNF- α or bradykinin (Noguchi *et al.*, 2002; Kiji *et al.*, 2007; Chotjumlong *et al.*, 2010; Båge *et al.*, 2011; Belibasakis and Guggenheim, 2011; Gutiérrez-Venegas and Arreguín-Cano, 2011). Increased levels of PGE₂ are detected in fibroblasts from patients with periodontitis compared to healthy controls (Båge *et al.*, 2011), although whether gingival fibroblast-derived PGE₂ drives gingival inflammation or is a cause of it remains to be determined. However, studies have suggested that PGE₂ has an autocrine effect on gingival fibroblasts by regulating their productions of IL-6 and OPG (Ko *et al.*, 1977; Noguchi *et al.*, 2002; Takashiba *et al.*, 2003; Kiji *et al.*, 2007).

Fibroblasts may regulate and suppress inflammatory and immune responses in the gingiva. Stimulation of gingival fibroblasts with TLR agonists or immunoregulatory cytokines (IFN- γ /IL-17/TNF- α) increases their production of the anti-inflammatory mediators indoleamine 2, 3-dioxygenase (IDO) and IL-10 (Mahanonda *et al.*, 2007; Mahanonda *et al.*, 2008; Khaled *et al.*, 2013). Furthermore, gingival fibroblast-derived IDO reduces T lymphocyte proliferation in co-culture models (Mahanonda *et al.*, 2007), supporting a role for gingival fibroblasts in suppressing inflammatory and immune responses in the gingiva. The adipokine adiponectin, which tends to be decreased in the circulation of obese individuals or those with T2DM, promotes anti-inflammatory gingival fibroblast responses (Iwayama *et al.*, 2012). This suggests that gingival fibroblasts may enhance or drive inflammatory responses in individuals who have T2DM or are obese. Yet gingival fibroblasts may also be a source of cytokines that stimulate proliferation and activity of leukocytes (Khaled *et al.*, 2013). Additionally, gingival fibroblasts stimulated with IFN- γ display increased surface MHC class II which supports the theory that fibroblasts promote adaptive immune responses in their local microenvironment (Mahanonda *et al.*, 2008; Seguin-Estevez *et al.*, 2009). Interestingly, IFN- γ also stimulates gingival fibroblasts to increase the surface expression of CD40 (Mahanonda *et al.*, 2008), and ligation of CD40 enhances the inflammatory response of fibroblasts (Dongari-Bagtzoglou *et al.*, 1997; Sempowski *et al.*, 1997; Wassenaar *et al.*, 1999). Overall, this suggests a bidirectional regulatory

relationship exists between gingival fibroblasts and lymphocytes which may be relevant to the pathogenesis of gingivitis and periodontitis.

1.11.5 Gingival fibroblasts as a unique cell type

Gingival fibroblasts have an ability to integrate their responses to environmental stimuli, which may determine how these cells regulate tissue remodelling, immune responses and inflammation. Distinct stimuli, or combinations of stimuli, can prompt the same outcome by activating similar intracellular pathways (e.g. NF- κ B/MAPK/PI3K) (Kida *et al.*, 2005; Bodet *et al.*, 2007; Uehara and Takada, 2007; Hosokawa *et al.*, 2008). Conversely, a single stimulus can promote different fibroblast responses, possibly in a concentration or time-dependent manner (Ruwanpura *et al.*, 2004). Alternatively, variation in gingival fibroblast responses could be due to intrinsic heterogeneity in cell populations. There is good evidence to suggest that fibroblasts have a sense of positional identity. Dermal and oral fibroblasts possess distinct phenotypes which correlate to the structure and functions of the surrounding tissues (Irwin *et al.*, 1994; Lekic *et al.*, 1997; Chang *et al.*, 2002a). For example, gingival fibroblasts from healthy human donors have a reduced ability to adhere and spread on ECMs after TGF- β stimulation compared to dermal fibroblasts (Guo *et al.*, 2011), which could be relevant to why wounded gingival tissue is less likely to scar than dermal tissue (Szpaderska *et al.*, 2003). However, phenotypic differences between gingival fibroblasts and other oral fibroblasts, and even between gingival fibroblasts (isolated from papillary and reticular layers) have been reported (Irwin *et al.*, 1994; Han and Amar, 2002), which suggests that intra-site heterogeneity also exists. This may also support the hypothesis that fibroblasts and mesenchymal stem cells in the gingiva are essentially the same cell type, although perhaps at different states of differentiation and/or activation (Phipps *et al.*, 1997; Haniffa *et al.*, 2009). Distinct phenotypes between fibroblasts from healthy and inflamed periodontal sites have been identified (Kent *et al.*, 1999), however in this study healthy and periodontal disease fibroblasts from different donors were compared so the differences observed could have been due to genetic heterogeneity between individuals. Overall, gingival fibroblasts certainly have the potential to regulate inflammatory and immune responses in the gingiva. However, the factors that determine the potentially beneficial or deleterious outcomes of gingival fibroblast stimulation during inflammation are still not fully understood.

It has been difficult to identify whether gingival fibroblasts have a protective or pathogenic role during inflammation *in vivo*. This is partly due to the redundancy of the

cellular sources of inflammatory molecules, such as proteases, cytokines and their regulatory counterparts in the gingiva coupled with the lack of a gingival fibroblast-specific marker that could facilitate genetic manipulation studies. Nonetheless, while there may be redundancy in the gingiva between the products of fibroblasts and other resident and recruited cells, it appears that fibroblasts generate these products in a manner that is quite unique (Black 2007). For example, profiling of intracellular signalling has shown that LPS-stimulated gingival fibroblasts upregulate IL-6 in a manner distinct to monocytes, which may result in different responses between these cells during inflammation (Jin *et al.*, 2012). Additionally, unlike monocytes, gingival fibroblasts do not develop tolerance to *E. coli* or *P. gingivalis* LPS (Ara *et al.*, 2009), which supports the theory that fibroblasts can drive the persistence of chronic inflammation, or lack of resolution of acute inflammation (Buckley, 2011; Naylor *et al.*, 2012; Owens and Simmons, 2013). Are gingival fibroblasts a causal factor in the initiation of gingival inflammation and do they play a role in the pathogenesis of periodontitis? Could certain populations at risk of developing periodontitis promote deleterious gingival fibroblast responses during inflammation?

Gingival fibroblasts maintain the structure and function of the gingiva. This homeostatic function is evidenced by their ability to produce ECM components and to promote gingival tissue remodelling during wound repair. However, gingival fibroblasts are immunocompetent cells responsive to a wide range of inflammatory and immune stimuli. These stimuli cause gingival fibroblasts to alter their phenotype in a manner both similar and distinct to other fibroblasts and immunocompetent cells. While the biologically active mediators produced by gingival fibroblasts are not in themselves unique, the way inflammatory stimuli cause gingival fibroblasts to regulate their phenotype does differ from other cell types. This places gingival fibroblasts in a unique position to regulate inflammatory processes, and may be relevant to the pathogenesis of periodontitis. Studies that pinpoint the mechanisms and temporal relationship behind gingival fibroblast responses during inflammation, and *in vivo* studies that put these responses into context, will help to further our understanding of this important and unique cell during inflammation and immunity and may help to elucidate why periodontitis is currently so difficult to cure.

1.11.6 Gingival fibroblasts and leptin

Only one very recent study has investigated the ability of leptin to regulate gingival fibroblast responses. Park *et al.* (2013) showed that primary hGFs express both long and

short leptin receptor isoforms, but not leptin, at the mRNA level. The authors showed that recombinant leptin dose-dependently increases IL-6 and CXCL8 secretion by hGFs. This suggests that gingival fibroblasts respond to leptin in a proinflammatory manner, and may be mechanistically relevant to the pathogenesis of periodontitis in the context of elevated levels of leptin.

Circulating levels of leptin are elevated in obesity and T2DM, and both of these conditions are positively associated with periodontitis. Leptin promotes inflammation and ECM remodelling, processes implicated in the development of periodontitis. Fibroblasts are the predominant cell type in the gingiva and can sense and respond to numerous stimuli in their microenvironment. Inflammatory stimuli (including leptin) drive gingival fibroblasts towards a proinflammatory phenotype. Periodontitis is characterised by destruction of the periodontal tissues and gingival fibroblasts, stimulated by inflammatory mediators, enhance the degradation of ECM components. Leptin enhances the matrix-degrading potential of several cell types, however no-one has assessed whether leptin has a similar effect on gingival fibroblasts. In this thesis it is hypothesised that leptin acts as a mechanistic link between obesity, T2DM and periodontitis by promoting inflammatory responses in gingival fibroblasts. In particular, it is hypothesised that leptin (either alone or in synergy with other inflammatory mediators) stimulates the production of the ECM-degrading MMPs by gingival fibroblasts, and that this will increase gingival tissue degradation.

1.12 Aims

1. To determine whether leptin increases MMP expression in hGFs.

Both semi-quantitative and real-time RT-PCR were used to assess mRNA expression levels of MMPs and TIMPs after leptin stimulation in hGFs. ELISA was used to determine the levels of MMPs in the supernatants of leptin-stimulated hGFs.

2. To determine whether leptin synergises with proinflammatory stimuli to increase the production of MMPs identified in (1) in hGFs.

hGFs were stimulated with leptin in combination with proinflammatory mediators (IL-1, OSM) and TLR agonists (*E. coli* LPS, pam2CSK4). Both semi-quantitative and real-time RT-PCR were used to assess mRNA expression levels of MMPs and TIMPs in stimulated hGFs. ELISA was used to determine the levels of MMPs in the supernatants of stimulated hGFs. Surface expression levels of TLR2 and TLR4 on hGFs were measured by flow cytometry.

3. To investigate which signalling pathways are involved in leptin-mediated MMP-1 expression in hGFs.

Semi-quantitative RT-PCR and flow cytometry were used to determine the expression of leptin receptor isoforms by hGFs. The phosphorylation statuses of intracellular signalling proteins were measured by Western blot in hGFs after stimulation with leptin, alone and in combination with IL-1 or pam2CSK4. Intracellular signalling pathways of interest identified by Western blot were pharmacologically inhibited and MMP gene expression was measured in hGFs after stimulation with leptin, alone and in combination with IL-1 or pam2CSK4.

4. To assess genome-wide RNA expression patterns in hGFs stimulated with leptin±IL-1.

hGFs were stimulated with leptin±IL-1β and MMP-1 mRNA expression was assessed using real-time RT-PCR to determine whether the stimulation was successful. High quality RNA was used for genome-wide expression analysis. Individual and related groups of genes that were regulated by leptin±IL-1 were identified using bioinformatics analysis. Real-time RT-PCR was used to confirm the differential expression changes of 8 genes.

5. To investigate the role of leptin on tissue integrity in a gingival tissue explant model system

Gingival tissue was assessed for utility as a model system of tissue integrity by measuring explant viability and the ability of a potent cytokine stimulus (IL-

1+OSM) to promote gingival ECM degradation. Gingival tissue explants were stimulated with leptin+IL-1 and gingival tissue integrity was determined by measuring the proportion of collagen released from the gingival tissue, and by measuring MMP activity in culture supernatants.

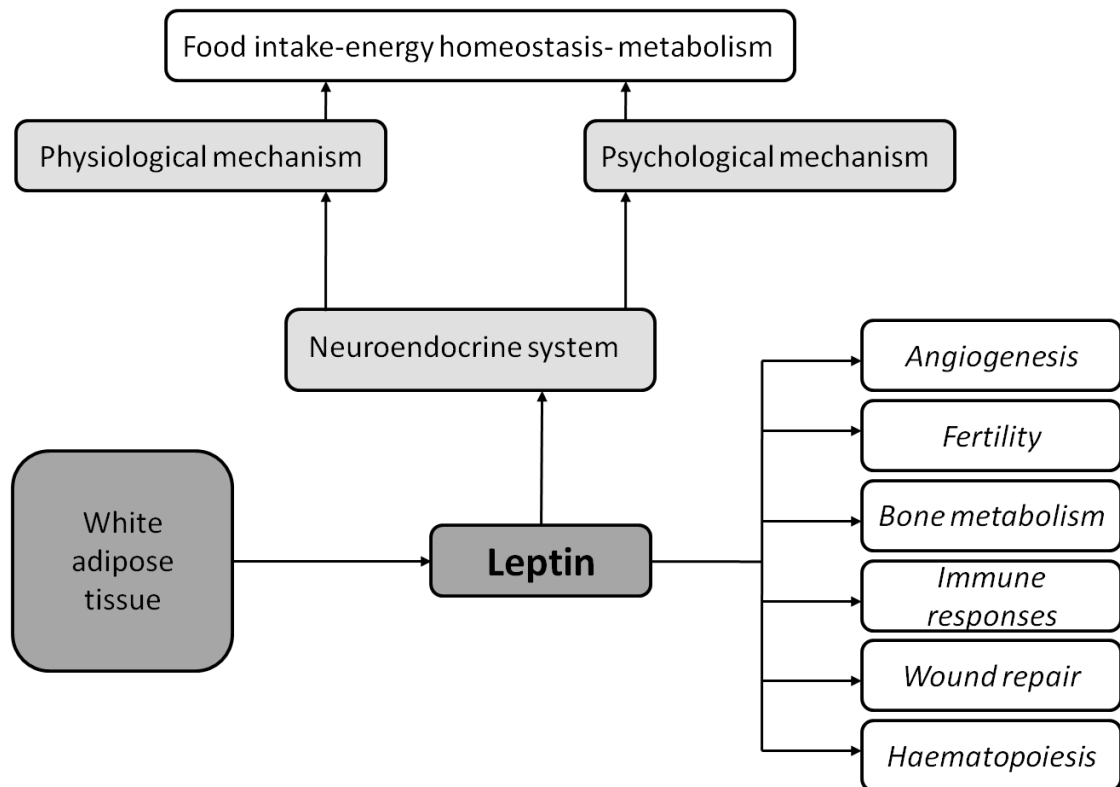

Figure 1.1: The functions of leptin.

Leptin is produced predominantly from white adipose tissue. Much is known regarding leptin's hormonal functions in the neuroendocrine system. Specifically, leptin drives physiological and psychological mechanisms that regulate food intake, energy homeostasis and metabolism. More recently, leptin has been found to regulate a wide range of other biological processes (in italics).

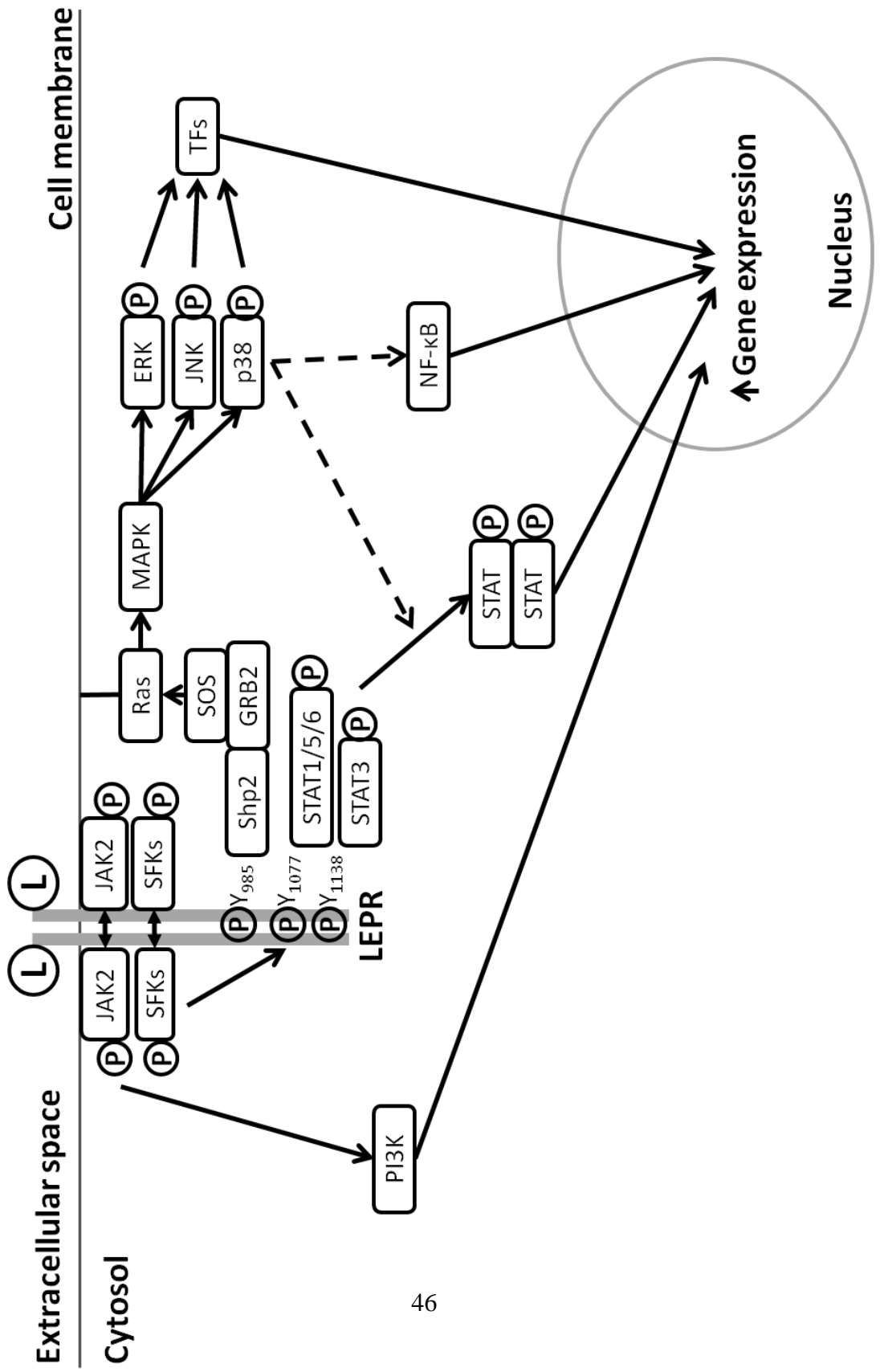

Figure 1.2: Aspects of the leptin signalling pathway.

Leptin (L) binds to the leptin receptor (LEPR) in a 2:2 ratio. This promotes the activation of constitutively-bound JAK2 and SFKs by transphosphorylation. The leptin receptor has no integral kinase activity. Activated JAK2 and SFKs phosphorylate three tyrosine residues in the membrane distal region of the intracellular domain of the leptin receptor (Y985, Y1077 and Y1138). These phosphorylated tyrosine residues facilitate the binding of SH2 domain-containing proteins, which are then phosphorylated (and usually activated) by JAK2 and SFKs. The phosphatase Shp2 binds to phosphorylated Y985, which in turn facilitates the binding of GRB2 and the guanine nucleotide exchange factor SOS. SOS activates membrane-bound Ras which activates the MAPK signalling pathway. The MAPK signalling pathway is a kinase cascade that results in the activation and phosphorylation of the MAPKs ERK, JNK and p38. These MAPKs activate transcription factors that relocate to the nucleus to promote gene expression. STATs bind to phosphorylated Y1077 and Y1138 of the leptin receptor. JAK2 phosphorylates and activates STATs. Activated STATs form homodimers which function as transcription factors, and relocate to the nucleus to promote gene expression. MAPK signalling can regulate the activity of the NF- κ B and STAT signalling pathways. Interestingly, leptin:leptin receptor binding also activates the PI3K signalling pathway; a function that may be independent of the phospho-tyrosine residues on the leptin receptor. Dashed arrows indicate possible interactions between different signalling pathways. Leptin affects the expression of a diverse range of genes including cytokines, chemokines and MMPs. L – leptin, JAK2 – Janus kinase 2, SFK – Src family kinase, P – phosphorylated molecule, Y – tyrosine residue, LEPR – leptin receptor, GRB2 – growth factor receptor-bound protein 2, SOS – Son of Sevenless, MAPK – mitogen-activated protein kinase, ERK – extracellular signal-related kinase, JNK – c-Jun N-terminal kinase, STAT – signal transducer and activator of transcription.

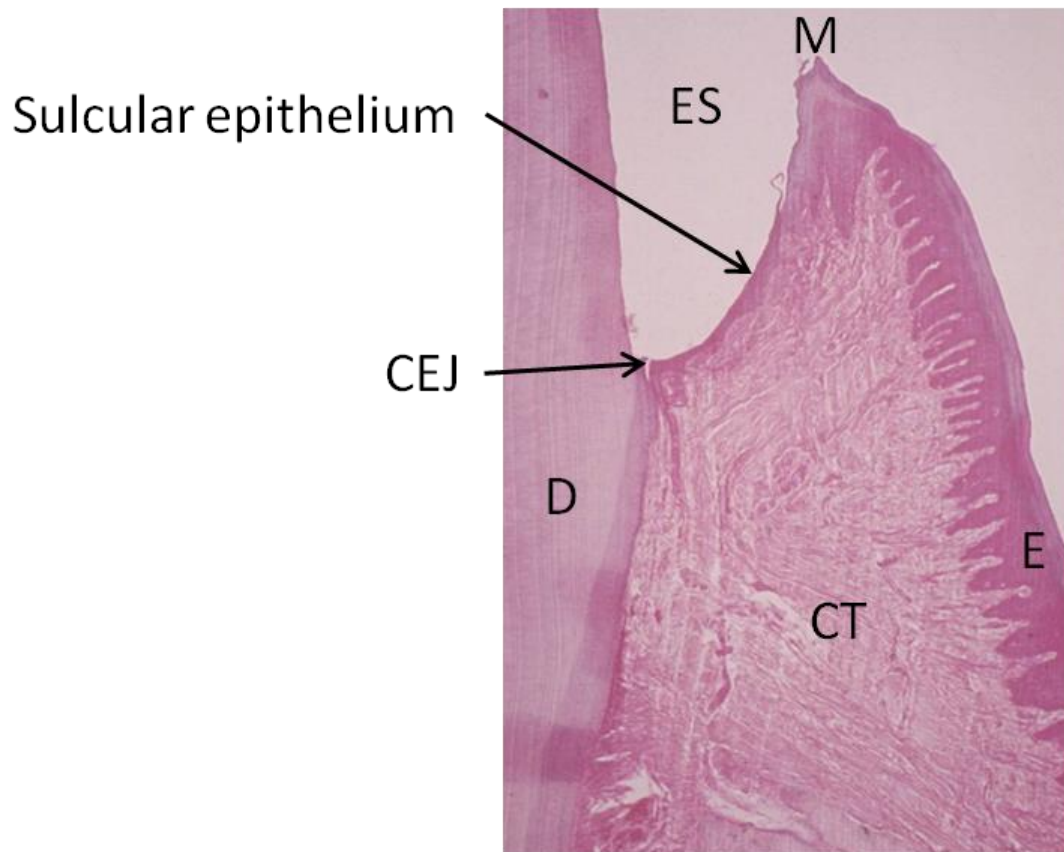

Figure 1.3: Haematoxylin and eosin section of the healthy human gingiva.

Dentine (D) which is found in the root of the tooth is covered by cementum. Cementum interacts directly with the periodontal ligament within the gingival connective tissue (CT). The gingival connective tissue is rich in collagen fibres. The epithelium (E) which covers the external surface of the gingiva consists of three distinct types. The keratinised gingival epithelium covers the external surfaces of the gingiva, from the muco-gingival margin to the free gingival margin (M). The sulcular epithelium covers the gingiva from the free gingival margin (M) into the gingival sulcus, essentially facing the enamel crown of the tooth. In this image there is a space where the enamel would have been (enamel space - ES); this is due to the processing required to section teeth for histological analysis. Junctional epithelium is found at the base of the gingival sulcus between the sulcular epithelium and the tooth surface at the cemento-enamel junction (CEJ). Image adapted from Preshaw (2014).

Table 1.1: The mammalian MMPs.

There are 26 mammalian MMPs which are split into 6 groups based on substrate specificity and structural characteristics. Example cellular sources of MMPs are displayed (Birkedal-Hansen, 1993; Kessenbrock *et al.*, 2010). MMP – matrix metalloproteinase, DCs – dendritic cells.

Group	MMPs	Cellular sources	Substrates
Collagenases	MMP-1 MMP-8 MMP-13	Macrophages Fibroblasts DCs Keratinocytes Neutrophils Fibroblasts	Fibrillar collagens
Gelatinases	MMP-2 MMP-9	Macrophages Mast cell Endothelial cells Fibroblasts DCs Keratinocytes Neutrophils Macrophages Lymphocytes Mast cells Fibroblasts DCs Keratinocytes	Broad specificity Gelatin Type IV collagen
Stromelysins	MMP-3 MMP-10 MMP-11	Lymphocytes Endothelial cells Fibroblasts DCs Keratinocytes Fibroblasts	Broad specificity
Matrilysins	MMP-7 MMP-26	Macrophages Endothelial cells	Broad specificity
Membrane-type MMPs	MMP-14 MMP-15 MMP-16 MMP-17 MMP-24 MMP-25	Macrophages Endothelial cells Fibroblasts	Broad specificity
Others	MMP-12 MMP-19 MMP-20 MMP-21 MMP-23 MMP-27 MMP-28	Macrophages Endothelial cells Fibroblasts DCs	

2 Chapter 2. Methods

2.1 Materials

Cell culture plastic-ware was supplied by Greiner Bio-one (Stonehouse, UK). All reagents were supplied by Sigma-Aldrich (Gillingham, UK) except where indicated. Molecular biology grade water was used where required; otherwise deionized, purified water was used. Chemical pathway inhibitors SP600125, UO126, Bay11-7085 and PD98059 were from Tocris (R&D systems, Abingdon, UK), while S3I-201, SB203580, Akt inhibitor VIII and I κ B kinase (IKK) inhibitors VI and VIII were from Merck Millipore (Watford, UK). All chemical pathway inhibitors were reconstituted in dimethyl sulphoxide (DMSO). The MMP inhibitor GM6001 (Tocris) was prepared at 20 mM in DMSO. Pam2CSK4 (Invivogen, Source Bioscience, Nottingham, UK) was prepared as a 100 μ g/ml solution in Limulus amebocyte lysate (LAL) reagent grade water (<0.005 EU/ml endotoxin). LPS from *Escherichia coli* (*E. coli*) strain 0111:B4 (Invivogen) was prepared as a 5 mg/ml solution in sterile water. Aliquots of inhibitors, pam2CSK4 and LPS were stored at -20 °C.

2.1.1 Recombinant proteins

Lyophilised human recombinant leptin (R&D Systems) was prepared as a 1 mg/ml solution in 20 mM tris(hydroxymethyl)aminomethane (TRIS)-HCl, pH 8. Human recombinant IL-1 α (670 ng/ml) was a gift from Dr Keith Ray (GlaxoSmithKline). Recombinant OSM (10 μ g/ml) was prepared by researchers in the musculoskeletal research group (Newcastle University) according to the method of Staunton et al (1998). Human recombinant IL-1 β (R&D Systems) was prepared at 25 μ g/ml in 0.1 % w/v endotoxin-free bovine serum albumin (BSA) in Dulbecco's phosphate buffered saline (PBS). Aliquots of reconstituted proteins were stored at -80 °C. Further dilutions were prepared in serum-free Dulbecco's modified eagle medium (DMEM). Recombinant human MMP-1 (R&D Systems) was stored at -80°C at 0.458 mg/ml.

Leptin reconstituted in the Translational Oral Biosciences lab was tested for endotoxin contamination by Dr Katrin Jaedicke using the LAL assay (Jaedicke, 2010).

Recombinant human leptin at 100 μ g/ml contained a concentration of 53 pg/ml LPS. In this study the highest concentration of leptin used was 25 μ g/ml, which would have contained 13.3 pg/ml LPS. Previous studies demonstrated that leptin at this concentration failed to stimulate TNF- α production by monocytes, further confirming the lack of biologically active LPS in this preparation (Jaedicke *et al.*, 2013). Several

studies have utilised *E. coli* LPS to stimulate gingival fibroblasts (Kent *et al.*, 1999; Xiao *et al.*, 2001; Nagasawa *et al.*, 2002; Tardif *et al.*, 2004; Mahanonda *et al.*, 2007; Minami *et al.*, 2007; Ara *et al.*, 2009; Feghali *et al.*, 2009; Jin *et al.*, 2012).

Concentrations in the ng – µg/ml range were required to generate responses.

Additionally, leptin strongly activates the JAK/STAT signalling pathway in hGFs, and has little effect on NF-κB signalling which is activated downstream of TLR ligation (Section 5.3.4).

2.2 Tissue culture techniques

All tissue culture was performed using aseptic technique in a class II laminar flow unit (BioAir, Biological Instrumentation Services, Manchester, UK). Where available reagents purchased were sterile and endotoxin-free. Subsequent sterilisation was performed by using a high temperature, high pressure autoclave and/or a 0.22 µm filter. Tissue and cells were incubated in a 5 % CO₂ atmosphere at 37 °C unless otherwise indicated. Ca²⁺/Mg²⁺-free PBS was supplemented with penicillin (100 U/ml), streptomycin (100 µg/ml) and nystatin (40 U/ml). DMEM containing 4.5 g/L glucose was supplemented with penicillin (100 U/ml), streptomycin (100 µg/ml) and L-glutamine (2 mM). DMEM was either used as a serum-free medium (SFM) or supplemented with 10% v/v foetal bovine serum (FBS) (DMEM+). Nutrient mixture F-12 Ham medium was supplemented with penicillin (200 U/ml), streptomycin (200 µg/ml) and nystatin (80 U/ml).

2.2.1 Primary hGF isolation

Gingival tissue was acquired anonymously from patients undergoing canine tooth exposure surgery (performed by Dr John Meechan, Newcastle Dental Hospital). Ethical approval was obtained from the national research ethics service committee North East (County Durham and Tees Valley). The tissue was placed in F-12 Ham medium on ice until processed. The tissue was orientated using a stereo microscope. Gingival tissue has a distinct, smooth keratinised epithelium, and a more vascular, less dense connective tissue layer. After three washes in PBS the epithelium was removed by scalpel and the remaining tissue was dissected into 2 mm³ sections. Tissue sections were squashed onto the surface of a tissue culture plate and just covered in DMEM+ to promote hGF adherence and outgrowth. The medium was replaced as required and the tissue was incubated for approximately 2 weeks to allow for hGF migration, forming a monolayer on the plate surface. The outgrowth protocol for hGFs has been published previously

(Mahanonda *et al.*, 2007; Belibasakis *et al.*, 2013; Khaled *et al.*, 2013). Consequently, the remaining tissue was removed and the hGFs subcultured.

2.2.2 Primary hGF subculture

hGFs are adherent cells that grow in monolayer to confluence on tissue culture plasticware in DMEM+. These cells demonstrate the spindle-shaped morphology characteristic of fibroblasts (Figure 2.1), and towards confluency the cells align in the same orientation (Figure 2.2), similar to that described previously (Kanda-Nakamura *et al.*, 1996; Beertsen *et al.*, 1997; Chang *et al.*, 2002b). hGFs were cultured in monolayer until 80% confluent, as determined by visual inspection with a light microscope (DM IL, Leica Microsystems, Milton Keynes, UK). To passage, cells were washed in PBS then covered with 0.25 % w/v trypsin-ethylenediaminetetraacetic acid (EDTA) solution and incubated until detached (< 3 minutes). An excess of DMEM+ was added to the cell suspension to quench the trypsin. The cells were pelleted by centrifugation (168 x g, 5 minutes, 20°C, CR3i multifunction centrifuge (ThermoFisher Scientific, Loughborough, UK)) and then resuspended in DMEM+. At this point hGFs were routinely > 99 % viable by trypan blue exclusion (Section 2.2.4). Cells were subsequently seeded either into culture flasks to maintain cultures, seeded into plates for stimulation experiments, or cryopreserved (Section 2.2.5) for future use. hGFs remained viable but were found to stop dividing at passage 13, indicative of cellular senescence. hGFs from one donor were tested for mycoplasma by Dr Helen Bosomworth and no trace of contamination was detected.

2.2.3 hGF characterisation

Vimentin is an intermediate filament protein which is expressed in mesenchymally-derived cells, such as fibroblasts. Therefore, vimentin expression was determined by immunocytochemistry (Section 2.3) in hGF cultures to investigate whether the cells isolated from the gingival tissue were indeed fibroblasts. Cells from all donors tested which were incubated with mouse monoclonal anti-human vimentin antibody stained positive strongly compared to the no antibody control (NAC), which suggests that the cells isolated from gingival tissue using the technique in Section 2.2.1 are mesenchymally-derived (Figure 2.2). The staining observed was limited to the cytoplasm but extended throughout the cell in the manner expected of an intermediate filament. In dividing cells staining was particularly intense at the periphery of the cell (Figure 2.2B). Vimentin has an altered distribution during mitosis (Aubin *et al.*, 1980),

so this staining pattern is evidence in support of the antibody binding vimentin and not other cellular targets in a non-specific manner.

2.2.4 Cell counting and viability assessment by haemocytometer

Equal volumes of cell suspension and trypan blue (0.4 %) were incubated at room temperature (RT) for 30 seconds, after which a sample of the mixture was loaded onto a haemocytometer. The cells were counted and assessed for viability, by trypan blue exclusion, under a light microscope. The Bright-Line Haemocytometer (Hausser Scientific, VWR, Lutterworth, UK) used has a Neubauer ruling pattern and therefore the number of cells/ml was determined using the formula:

$$\text{cells/ml} = \text{number of cells counted in } 1 \text{ mm}^2 \times 2(\text{dilution factor}) \times 10^4$$

Cell morphology and adherence to culture surfaces were also noted. Cells which were <90% viable or poorly adherent were not used for stimulation experiments.

2.2.5 Cryopreservation and recovery of hGFs

hGFs were pelleted by centrifugation (168 x g, 5 minutes, 20°C, CR3i multifunction centrifuge). Pellets of hGFs were resuspended in DMEM+ supplemented with 10% v/v glycerol to give a cell density of > 1x10⁶ cells/ml. Aliquots were dispensed into cryovials and placed in a propan-2-ol-containing freezing container in a -80°C freezer. Once cooled to -80°C the cryovials were transferred to liquid nitrogen for long term storage.

hGFs were revived from cryopreservation by quickly warming to 37°C. hGFs were seeded into a cell culture flask and DMEM+ was slowly added to the flask. hGFs were then incubated and after the cells were adherent the medium was changed to remove any residual cryopreservant and non-viable cells. hGFs were subcultured at least once before being used in an experiment.

2.2.6 In vitro stimulation of hGFs

hGFs were seeded at various densities in DMEM+ depending on plastic-ware format (Table 2.1). In the 96-well format wells at the edge were filled with PBS to stop evaporation of medium from hGF-containing wells. Seeded hGFs were incubated until 80-90 % confluent at which point the cells were either processed for downstream applications, or serum-starved (washed in PBS and media replaced with SFM) for 18 hours and then stimulated for ≤ 48 hours. hGFs were used in stimulation experiments between passages 5 and 9.

2.2.6.1 *Chemical pathway inhibitors*

The ability to inhibit specific signalling molecules, and therefore, particular signalling pathways is a useful tool for understanding the mechanisms of cell signalling events. Small molecule, chemical pathway inhibitors have been used extensively for this purpose, including with hGFs (Ravenhall *et al.*, 2000; Yucel-Lindberg and Brunius, 2006; Tong *et al.*, 2008). It is important to test that these inhibitors are specifically inhibiting their target, and that at the concentrations required to do this there is no alteration in cell viability.

Chemical pathway inhibitors (Section 2.1) were tested for their potential to affect cell viability. For each inhibitor, a 6-point, 3-fold dilution series (n=2 per concentration) was performed using concentrations which included those suggested to effectively inhibit the pathway of interest according to the manufacturer. Inhibitors were diluted in SFM. DMSO controls of 1, 0.4, 0.1 and 0.03 % v/v which were equivalent to the highest concentration of DMSO in inhibitor treatments were performed to investigate any effect of DMSO on cell viability. hGFs were stimulated for 24 h at which point viability was assessed using a colourimetric cell proliferation assay (Section 2.5.1).

Morphological changes indicative of toxicity (rounding/shrinking/poor adherence) were observed at 24 h by light microscope for hGFs treated with the highest concentrations of PD98059 and Akt inhibitor VIII. Indeed, Akt inhibitor VIII caused a reduction in hGF proliferation in a dose-dependent manner (Figure A.1B). In contrast, a slight increase in proliferation was observed in hGFs treated with PD98059 although not as much as the DMSO-treated control (Figure A.1D). It is likely however, that the increased proliferation and morphological changes observed by the highest concentrations of PD98059 were due to DMSO and not PD98059 itself. The highest concentration of PD98059 tested contained 1 % DMSO and this concentration of DMSO alone caused an 18 % increase in proliferation compared to non-treated cells. A dose-dependent decrease in hGF proliferation was demonstrated by Bay11-7085 treatment, while hGFs treated with the highest concentrations of S3I-201 and SB203580 had reduced proliferation compared to the untreated and DMSO controls (Figure A.1). No dose-dependent changes in proliferation were observed for hGFs treated with U0126, SP600125 or IKK inhibitors VI and VIII, and proliferative responses correlated to the untreated and DMSO controls (Figure A.1).

Concentrations of chemical pathway inhibitors that had no negative effect on cell proliferation were used to test for efficacy in inhibiting the phosphorylation of cell signalling intermediates. hGFs were pre-treated with inhibitors or a 0.1 % DMSO control for 30 min. hGFs were then stimulated with 0.05 ng/ml IL-1 α and 5 ng/ml OSM for 20 minutes. At this time point hGFs were lysed in preparation for sodium dodecyl sulphate (SDS)-polyacrylamide gel electrophoresis (PAGE) and immunoblotting (Section 2.11).

The MAPK/Erk kinase (MEK) inhibitor U0126, but not the MEK inhibitor PD98059, greatly inhibited the phosphorylation of ERK1/2 in hGFs after IL-1+OSM stimulation compared to the DMSO-pretreated control (Figure B.1A). As such, U0126 was chosen as the inhibitor used in this work to study ERK signalling. The p38 inhibitor SB203580 affects p38 activity independently of its phosphorylation by binding to the ATP-binding pocket. However, SB203580 has been reported to modulate ERK activity (Henklova *et al.*, 2008). In hGFs, SB203580 had no effect on ERK phosphorylation induced by IL-1+OSM (Figure B.1A). The JNK inhibitor SP600125 inhibited both JNK and ERK phosphorylation in a dose-dependent manner in hGFs after IL-1+OSM stimulation (Figure B.1B). The higher concentration of SP600125 (10 μ M) was chosen to study JNK activity in this thesis; however the concomitant inhibition of ERK by this inhibitor was a limitation that was taken into account. The NF- κ B inhibitors IKK VIII and Bay11-7085, but not the NF- κ B inhibitor IKK VI, inhibited NF- κ B p65 phosphorylation in hGFs after IL-1+OSM stimulation (Figure B.1C). Bay11-7085 was selected to study NF- κ B activity in this study. Akt inhibitor VIII greatly reduced the phosphorylation of both Ser473 and Thr308 in hGFs after IL-1+OSM stimulation (Figure B.1D), and was selected for use in this thesis. The STAT3 inhibitor S3I-201 slightly reduced the phosphorylation of Tyr705, but had little effect on Ser727 phosphorylation, in hGFs after IL-1+OSM stimulation (Figure B.1E).

2.2.7 Preparation of hGFs for flow cytometry

Adherent hGFs were washed with PBS then covered with 0.25 % Trypsin-EDTA and incubated until detached (< 3 minutes). An excess of DMEM+ was added to the cell suspension to quench the trypsin. hGFs were pelleted by centrifugation (168 x g, 5 minutes, 20 °C, CR3i multifunction centrifuge (ThermoFisher Scientific)) and then resuspended in 0.5 % w/v BSA in PBS. hGFs were counted and assessed for viability by trypan blue exclusion using a haemocytometer (Section 2.2.4). The cells were

centrifuged (168 x g, 5 minutes, 20 °C) and the pellet resuspended in 0.5 % w/v BSA in PBS to give a density of 4×10^6 cells/ml for flow cytometry analysis (Section 2.10).

2.2.8 Staining gingival tissue for triglycerides

Gingival tissue was acquired and processed according to Section 2.2.1. Dissected gingival tissue pieces were placed into 24-well plates and washed in PBS. Tissue pieces were resuspended in 1 ml PBS to which 30 μ l AdipoRed (Lonza, Slough, UK) was added. Tissue pieces were then incubated for 10 minutes at RT. AdipoRed contains the stain Nile Red and allows for the vital visualisation of lipids by assessing the fluorescence which occurs when Nile Red is partitioned in fat droplets. However, a pink-coloured staining can also be observed with AdipoRed using a light microscope (CKX41 model, Olympus, Southend-on-Sea, UK); this crude approach allows for quick generation of images that show tissue morphology and fat droplet localisation.

2.2.9 Gingival tissue stimulation

Gingival tissue was acquired and processed according to Section 2.2.1. One 2 mm³ piece of tissue was placed per well (96-well format), washed with PBS then suspended in 200 μ l DMEM+ overnight. The following day the DMEM+ was aspirated, and the tissue was washed with PBS. Tissue pieces were resuspended in stimulation treatments diluted in SFM. Treatments were changed routinely every 3-4 days over the 3 week culture period and removed supernatants were stored at -20 °C until analysis. At the end of the experiment the tissue pieces were washed in PBS before storage at -20 °C for subsequent analysis.

Gingival tissue pieces used for *ex vivo* culture were susceptible to both fungal and bacterial contamination. Both yeast-like single cells and hyphae were observed by light microscopy in fungal contaminations indicative of *Candida* spp, while cells with cocci morphology were observed in bacterial infection. Microbial contamination only occurred in the first few days of *ex vivo* culture, and only in particular donors.

Therefore, as the oral environment from which the tissue was isolated is microbe-rich it was thought that the most likely source of contamination was the tissue itself. If any gingival tissue pieces had visual signs of microbial contamination all tissue pieces from this donor were destroyed.

2.2.9.1 Papain-mediated digestion of gingival tissue

Papain is a cysteine protease and is effective at digesting numerous proteins, including collagen and other ECM components. Digestion of gingival tissue with papain thus

disrupts gingival tissue ECM allowing for downstream measurement of the hydroxyproline and glycosaminoglycan (GAG) content of gingival tissue. Stimulated gingival tissue pieces were digested in 200 µl of 4.5 mg/ml papain (Merck, Hoddesdon, UK) in a 0.1 M phosphate ($\text{NaH}_2\text{PO}_4/\text{Na}_2\text{HPO}_4$ (both VWR)) buffer, pH 6.5 containing 5 mM EDTA (disodium salt) and 5 mM cysteine-HCl. Tissue-containing wells were sealed to eliminate evaporation and incubated until digested (≤ 18 h). Once cooled, acid hydrolysis was performed on the digests (Section 2.13.1).

2.3 Immunocytochemistry

Glass slides (13 mm diameter) were washed (1x 100% ethanol, 3x PBS) and placed into 24 well plates. Cells were seeded into the plates (Table 2.1) and incubated until confluent. Next, cells were fixed in ice-cold methanol (Fisher Scientific) for 15 minutes, and then washed once in TRIS-buffered saline (TBS), pH 7.6. The slides were then incubated for 1 h at RT in either mouse monoclonal anti human vimentin primary antibody (IgG2b, Clone Vim 3B4) (Dako, Ely, UK) diluted 200-fold in diluent (3% v/v FBS in TBS, pH 7.6) or diluent alone as a NAC. The antibody was removed by washing (3x 5 min in TBS, pH 7.6) before the slides were incubated in Envision polymer (Dako) for 30 min at RT. The slides were washed again (3x 5 min in TBS, pH 7.6) before incubation in freshly prepared diaminobenzidine solution (Dako) for 5 min at RT. Excess diaminobenzidine was removed by washing (1x 5 min in water) before the slides were counterstained with haematoxylin for 1 min at RT. Excess haematoxylin was removed by washing (1x 5min in water) before the slides were mounted onto microscope slides. Cells were visualised and images taken with a DM500 microscope (Leica microsystems).

2.4 Histological processing of gingival tissue

Gingival tissue was acquired according to Section 2.2.1. The tissue was placed in a 10 % formalin solution for 24 h at RT either as unprocessed tissue or after sectioning using precision cutting (Section 2.4.1). Next, the tissue was rinsed in water for 10 min and stored in 70 % v/v ethanol for approximately 72 h.

Whole tissue samples were sent to a Biobank facility (Newcastle University) for processing and embedding in wax. Sections of whole gingival tissue were cut using a microtome (Leica microsystems) and placed onto microscope slides. Sections were left to dry overnight by incubating at 37 °C, and then stored at RT prior to staining (Section 2.4.2). In contrast, precision-cut tissue pieces were sent to the Royal Victoria Infirmary

(Newcastle upon Tyne) for processing, embedding and staining with haematoxylin and eosin (H+E).

2.4.1 Precision slicing of gingival tissue

This procedure was performed by Dr Stephen Hill (Fibrosis Research Group, Newcastle University). Briefly, freshly acquired gingival tissue was glued onto the stage of a vibratome (Model VTI200S, Leica microsystems). Precision cut sections of 250 µm were made using a blade speed of > 0.3 mm/s. Sections were suspended in Hank's balanced salt solution supplemented with 10 % FBS before the tissue was fixed and processed.

2.4.2 H+E staining of gingival tissue sections

Gingival tissue sections (from whole tissue samples) were de-waxed in xylene (2 x 5 min washes). Next, the sections were rehydrated through graded concentrations of ethanol (100-95-75-50 %, 3 min at each concentration). The sections were washed in water, and then stained with Mayer's haematoxylin for 90 sec. Next, the sections were washed in water for 1 min before being placed in Scott's tap water substitute for 1 min to stain the nuclei blue. The sections were washed in water for 3 min, then stained with eosin for 2 min and finally washed in water for 30 sec. The sections were then dehydrated through graded concentrations of ethanol (50-75-97-100 %, 2 min at each concentration). The slides were then cleared in xylene (2 x 5 min washes). DPX was used to mount a cover slip over the tissue section and left to dry. Tissue sections were visualised and images taken with a DM500 microscope.

2.5 Colourimetric cell proliferation assays

2.5.1 Tetrazolium compound method

Proliferation was assessed in hGFs using the Celltiter 96® A_{queous} one solution cell proliferation assay kit (Promega, Southampton, UK). The solution provided in this kit contains a tetrazolium compound which is reduced to form an insoluble coloured formazan product which can be detected by spectrophotometry. This conversion is presumed to be carried out depending on the levels of NAD(P)H, and can therefore provide an indication of the metabolic activity of a cell. However, metabolic activity may not always correlate to cell proliferation and this limitation must be taken into account.

SFM was added to two empty wells to allow for the assessment of background absorbance. After 22-23 hours post-stimulation Celltiter reagent (20 μ l/100 μ l supernatant) was added and mixed. hGFs were incubated until 24 hours post-stimulation, when all wells were mixed by pipette and the absorbance was measured at 490 nm using a Synergy HT plate reader (BioTek, Potton, UK). Results were calculated as % unstimulated or untreated control after the subtraction of the mean background absorbance. In the preliminary experiment assessing dose-dependent toxicity of chemical pathway inhibitors a four-parameter logistic (4PL) curve was fitted to the data in SigmaPlot (Systat Software, London, UK) (Section 2.2.6.1). In stimulation experiments hGFs exposed to DMEM supplemented with 5/10 % FBS were used as a positive control for proliferation (Figure 2.3).

2.5.2 Lactate dehydrogenase assay

Lactate dehydrogenase (LDH) is an enzyme found constitutively within all cells. When cell death occurs and plasma membrane integrity is lost, the contents of the cytosol are released into the supernatant. LDH activity in cell supernatants is therefore used to indicate the level of cell death in a sample.

In this study, LDH activity was measured using a LDH cytotoxicity assay kit (ThermoFisher Scientific). Substrate solution was reconstituted in 11.4 ml dH₂O. A reaction mix was prepared by adding assay buffer (0.6 ml) to the substrate solution and was stored at -20 °C until use. The positive control was prepared by diluting 1 μ l LDH positive control with 10 ml 1 % w/v BSA in PBS (assay diluent). Gingival tissue supernatants, the positive control, the diluent (blank control) and a SFM control were dispensed into a 96-well plate in duplicate (25 μ l/well). Reaction mix (25 μ l) was added to each well, mixed and incubated at RT for 30 min in the dark. Stop solution (25 μ l) was added to each well, mixed and absorbance was measured at 490 nm and 680 nm using a plate reader. The readings at 680 nm were subtracted from the readings at 490 nm to correct for plate interference. Results were calculated as % unstimulated control after the subtraction of the mean blank absorbance. A lower limit of quantification was determined as blank absorbance + 10SD as suggested by Armbruster *et al.* (1994). LDH activity was detected in the positive control supplied with the assay kit.

2.6 DNA and RNA extraction techniques

2.6.1 Total RNA purification

For conventional RT-PCR or where an assessment of the yield and quality of RNA was required, hGFs were lysed and RNA extracted from the lysate using the GenElute mammalian total RNA purification kit or RNeasy kit (Qiagen, Manchester, UK) following the manufacturer's instructions. Briefly (and for both kits), the culture medium was removed and cells were covered with ice-cold lysis buffer (containing guanidine thiocyanate and supplemented with 1 % v/v β -mercaptoethanol) for 1-2 minutes. The plates were rocked and tapped to promote total cell lysis and RNase inactivation before the lysate was transferred to a 1.5 ml tube and stored at -80°C if necessary. An equal volume of 70 % v/v ethanol was added to defrosted cell lysates and mixed by vortexing. This mixture was added to a total RNA binding silica column, centrifuged at 13000 rpm for 15 sec (Microcentaur centrifuge, MSE, London, UK), and the flow through was discarded. The RNA-bound column was washed three times to improve RNA purity. Finally, elution solution was added to the column and RNA eluted into a clean collection tube by centrifugation (13000 rpm, Microcentaur centrifuge, 1 min). RNA yield and quality were assessed by measuring absorbance at 260 and 280 nm on a spectrophotometer (Nanodrop, Thermofisher scientific). A 260/280 ratio of approximately 2 indicated pure RNA. RNA was kept on ice short-term or stored at -80°C .

2.6.2 Nucleic acid stabilisation

hGFs stimulated in a 96-well format were lysed and nucleic acids stabilised using the Sidestep lysis and stabilisation buffer (Stratagene, Agilent Technologies, Wokingham, UK). Briefly, the supernatant was removed and the cells were washed once with ice-cold PBS. To each well, 20 μl of lysis buffer was added, and cells were fully disturbed using a plate shaker (2 minutes, 900 rpm). Lysates were kept on ice short-term or stored at -80°C .

2.7 RT-PCR

2.7.1 Reverse transcription reaction

Reverse transcription was performed on RNA/lysates using the high-capacity cDNA reverse transcription kit (Applied Biosystems, Life Technologies, Paisley, UK) according to the manufacturer's instructions using a T100 thermal cycler (Bio-Rad, Hemel Hempstead, UK). Samples derived from total RNA purification were adjusted so

that they all contained the same RNA concentration. Samples derived from nucleic acid stabilisation were diluted 20-fold for reverse transcription reactions (1 µl per reaction as recommended by lysis buffer manufacturer). Controls containing nucleic acids but no reverse transcriptase were performed and were included in all downstream RT-PCR experiments. RNA (10 µl diluted in molecular grade H₂O as necessary) was mixed with 10 µl reverse transcription mastermix containing 8 mM dNTPs, 5 U/µl MuLV reverse transcriptase, and random primers and a buffer mix diluted according to the manufacturer's protocol. Samples were incubated at 25 °C for 10 min to promote primer annealing, then 37 °C for 120 min to promote reverse transcriptase-mediated extension, and finally at 85 °C for 5 min to inhibit enzyme activity. cDNA was stored at 4°C. cDNA derived from stabilised nucleic acid lysates were diluted 2.5-fold in water prior to use.

2.7.2 Conventional RT-PCR

RT-PCR was performed on cDNA (2.5 µl) by incubation with specific primers (2 µM final concentration), 1x BioMix Red reaction mix containing *Taq* DNA polymerase (Bioline, London, UK) and water for a 25 µl reaction. Controls containing water instead of cDNA were performed to control for contamination. Thermal cycling was performed in a T100 thermal cycler under the following conditions:

Step 1 (denaturation): 94°C, 5 min

Step 2: (60°C, 1 min for annealing, 72°C, 1 min for extension, 94°C, 1 min for denaturation) x 35 cycles

Step 3 (final extension): 72°C, 10 min

Table 2.2 displays the primers used and the expected product size. PCR products were confirmed by GelRed (Biotium, Cambridge Bioscience, Cambridge, UK)-containing agarose gel electrophoresis and images were captured under ultraviolet transillumination using Genesnap software on a G:Box imaging system (Syngene, Cambridge, UK). Hyperladders IV or V (Bioline) were run on all gels to confirm product size.

2.7.3 Real-time RT-PCR

cDNA (diluted in molecular grade H₂O as necessary) was mixed with 600 nM forward and reverse primers, 1X TaqMan universal mastermix (Applied Biosystems) and either 150 nM 5' carboxyfluorescein/3' tetramethylrhodamine PrimeTime qPCR probes

(Integrated DNA Technologies, Glasgow, UK) or 1X TaqMan assay (*POLR2A* Hs00172187_m1, *IL24* Hs01114274_m1, *COL6A3* Hs00915125_m1) (Applied Biosystems) to give a final reaction volume of 10 μ l per well in a 96-well PCR plate (Applied Biosystems). Controls containing water instead of cDNA were performed to control for contamination. PCR was performed on a 7900 HT real-time PCR system (Applied Biosystems). Table 2.2 lists the primer/probe sequences used. The cycling conditions used were as follows:

Step 1 (denaturation): 95°C, 10 min

Step 2 (annealing, extension, denaturation): (95°C for 15 s, 60°C for 1 min) x 40 cycles

Threshold cycle (C_t) values were acquired and the 2^{-ddC_t} analysis method was performed (Livak and Schmittgen, 2001) (Figure C.1). Relative quantitation was performed by normalisation to the reference gene RNA polymerase II (RNAP). The amount of cDNA used was determined by the ability of samples to generate sigmoidal amplification curves with a distinct exponential phase which generated a C_t between 15 and 35.

18S rRNA was also assessed for use as a reference gene in preliminary experiments. However, the C_t values for RNAP had a lower coefficient of variance (CV) than 18S rRNA both within and between treatment conditions suggesting that 18S rRNA was a less appropriate reference gene for hGFs (Figure C.2). Similar findings have been reported elsewhere (Schmittgen and Zakrajsek, 2000). As such, RNAP was chosen as the reference gene for real-time data in this study. Replicate PCR reactions were performed to establish the extent of technical variation. The CV was < 4 % and therefore subsequent PCR reactions for each sample were performed in single for each sample.

2.8 Microarray analysis

Two array formats were used to probe leptin stimulated hGFs for mRNA expression at a time point of 24 h. Ideally, gene expression would have been measured at multiple time points but only limited sample numbers could be analysed in this study. Microarray analysis requires a large quantity of good quality RNA. Therefore, samples for microarray analysis were generated using hGFs in a 6-well format.

2.8.1 TaqMan Low Density Array

The human immune panel TaqMan Low Density Array (TLDA) (Applied Biosystems) was used to explore gene expression in hGFs. For each sample, this array quantified the

expression of 96 genes. The genes on the array were pre-selected because their gene products function in immunity (Table D.1). Gene expression was determined by real-time RT-PCR but instead of preparing a reaction mix which contains primers and probes, the primers and probes were already distributed onto the microfluidic card.

Total RNA was purified from stimulated hGFs and quantified using the GenElute kit (Section 2.6.1). Equal amounts of RNA were used to generate cDNA by reverse transcription (Section 2.7.1). The amount of input RNA was calculated to generate cDNA (assuming 100 % conversion) in the range of 100-500 ng per reaction well to assess moderate levels of gene expression (as recommended in the manufacturer's protocol). cDNA (diluted in H₂O) and 1X TaqMan universal mastermix were mixed and then loaded by pipette into the sample reservoirs on the microfluidic card. The cards were then centrifuged (1200 rpm, 2 x 1 min, Heraeus multifuge 3L, Thermofisher Scientific) to distribute the sample into the reaction wells. Finally, the reaction wells were sealed using a card sealer (Applied Biosystems) and the sample reservoirs were removed.

Prior to RT-PCR of the TLDA a background run was performed to control for the microarray card format. Real-time PCR of the 384-well TLDA microarray card was performed on a 7900 HT real-time PCR system. The cycling conditions for real-time RT-PCR analysis were used (Section 2.7.3). C_t values were acquired and relative quantitation performed by normalisation to the reference genes 18S rRNA or β -actin (Livak and Schmittgen, 2001).

2.8.2 *Genome-wide expression microarray*

The Human HT-12 v4 expression beadchip (Illumina, Little Chesterford, UK) was used to explore genome-wide transcriptional profiles in hGFs. This array contains over 47000 probes from the National Center for Biotechnology Information RefSeq database release 38 that detects well-characterised genes as well as candidate genes and splice variants. This exploratory approach has the potential to identify novel genes regulated by leptin in hGFs. Each array has the capacity for 12 samples. The 12 samples chosen for analysis in this study included 4 treatment conditions (unstimulated, leptin, IL-1 β , leptin+IL-1 β) in three donors to allow for statistical analysis to be performed on the data.

hGFs from donors which were responsive to leptin and IL-1 were used in the stimulations for microarray analysis. hGFs were stimulated in duplicate to allow for

either pooling of samples or for choosing one sample for downstream analysis if poor quality RNA was generated. Total RNA was purified from stimulated hGFs using the RNeasy kit (2×10^5 cells/well) and quantified using the Nanodrop spectrophotometer (Section 2.6.1).

RNA (500 ng per sample) was sent to Cambridge Genomic Services (CGS, Cambridge, UK) for expression analysis using the Illumina beadchip. This service involved an additional quality control (QC) analysis. The RNA samples were analysed using an electrophoresis-based approach (2100 Bioanalyzer, Agilent Technologies) to generate a RNA integrity number (which should be > 8). Then, RNA amplification was performed using the TotalPrep 96-RNA amplification kit (Ambion, Life Technologies) to create biotin-labelled cRNA. This cRNA was hybridised onto the beadchip and assessed according to the workflow in Figure E.1A. Essentially, cRNA was hybridised to a complementary oligonucleotide probe. Each probe is linked via an address sequence to a bead which sits in a specific location on the array. Streptavidin conjugated to the fluorophore Cy3 is bound to biotin-conjugated cRNA and fluorescence is quantitatively detected local to each bead. The fluorescent signal intensity generated for each probe was reported by CGS and was used for bioinformatics analysis (Stekel, 2003).

Analysis of the microarray dataset was performed with the assistance of Mr Andrew Skelton (Musculoskeletal Research Group and Bioinformatics Support Unit, Newcastle University) using R Studio software (Boston, USA). The dataset acquired from CGS was normalised using the robust spline method. The quality of the dataset was confirmed using MA plots, mean v SD plots, box and whisker plots and density plots (Figure E.2). Principle component analysis identified that the datasets for the samples from one donor were different to the others in one dimension (Figure E.2E). Therefore, the dataset was corrected using the “ComBat/surrogate variable analysis” add-on to the R studio software to eliminate this variation, and to maintain the statistical power of the experiment (Johnson *et al.*, 2007; Leek and Storey, 2007).

After correction, the datasets for different treatment conditions were compared (unstimulated v leptin, unstimulated v IL-1, unstimulated v leptin+IL-1, leptin v leptin+IL-1, IL1 v leptin+IL-1) to generate lists of differentially expressed genes. Only genes which had a raw (not log-transformed) fold change of > 2 and a corrected p value of < 0.01 were considered differentially expressed. Corrected p values were generated

using the Benjamini-Hochberg method for multiple comparisons to reduce the likelihood of false positives.

Two enrichment analyses were performed on the differentially expressed gene lists to identify biological processes and pathways significantly over-represented in the selected comparisons (unstimulated v leptin, unstimulated v IL-1, unstimulated v leptin+IL-1). Gene ontology (GO) analysis (biological processes only) was performed using the “Gostats” add-on to the R Studio software. GO terms are a consistently labelled group of biological processes, arranged hierarchically, that are affiliated to genes based on existing biological knowledge regarding gene product function. Therefore, numerous genes are affiliated to the same GO term. Kyoto encyclopaedia of genes and genomes (KEGG) analysis was performed using the “pathview” add-on to the R Studio software. The KEGG database contains biological pathways in which the link between different gene products can be visualised. Therefore KEGG analysis can generate information relevant to the overall biological pathways that may be active under the conditions used to generate a dataset (e.g. pathways upregulated in leptin-stimulated hGFs compared to unstimulated hGFs).

Significant GO terms and KEGG pathways were deduced by performing a hypergeometric test. Essentially, this statistical test determines whether the observed number of genes associated with a GO term or KEGG pathway in a list of genes is significantly different to the number expected in a universal list of genes. In this study, only GO terms over-represented with a corrected p-value of <0.001 were considered significant. Only KEGG pathways over-represented with a corrected p-value of <0.01 were considered significant.

Only selected genes, GO terms and KEGG pathways relevant to inflammation or other processes in which leptin or IL-1 are thought to function (based on the existing literature) are presented in this study.

2.9 ELISA

hGF supernatants were assessed for human total MMP-1, total MMP-3, IL-6 and IL-24 by ELISA (R&D systems) according to the manufacturer’s protocol. The MMP ELISAs detected active and inactive MMP. Supernatants were stored at – 80 °C prior to analysis. The plates for the IL-6 ELISA were pre-coated and samples/standards could therefore be directly dispensed into the wells. For the other ELISAs (MMP-1, MMP-3 and IL-24), 96-well plates (R&D Systems) were coated with capture antibody diluted in

PBS at RT overnight. Next, the plates were aspirated and washed with 0.05 % Tween 20 in PBS (wash buffer) three times using a plate washer (BioTek). The plates were then blocked by filling each well with 1 % BSA in PBS (reagent diluent) for 1 h at RT. Meanwhile, 2-fold serial dilutions were performed with the standard in reagent diluent to give a seven-point standard curve (MMP-1 top standard: 10 ng/ml, MMP-3 top standard: 2 ng/ml, IL-6 top standard: 300 pg/ml, IL-24 top standard: 4 ng/ml). Similarly, cell culture supernatants were diluted in reagent diluent as necessary. The aspiration/wash step was repeated as above, and then 100 µl standards, samples or blank (reagent diluent) in duplicate were dispensed in the wells and incubated for 2 h at RT. Next, the aspiration/wash step was repeated as above, before a biotinylated detection antibody (diluted in reagent diluent) was added to the wells and incubated for 2 h at RT. Plates were aspirated/washed as above and then a streptavidin-horseradish peroxidase (HRP) solution (diluted in reagent diluent) was added to the wells for 20 min at RT in the dark. A final aspiration/wash step was performed as above before a 1:1 mixture of H₂O₂ and tetramethylbenzidine was added to the wells for 20 min at RT in the dark. Colour development was stopped by adding 2 N H₂SO₄ to the wells. The optical density of each well was determined at 450 nm and 550 nm using a Synergy HT plate reader. The readings at 550 nm were subtracted from the readings at 450 nm to correct for plate imperfections.

The mean readings for each standard concentration and the blank were used to generate a 4PL curve fit (Appendix K). Sample concentrations were determined from the standard curve and multiplied by any dilution factor. In some of the results obtained in this study there was substantial variation in the protein concentrations detected between donors; however the pattern of response remained the same. In this circumstance, protein levels were expressed in relation to the unstimulated control (either as a percentage or fold change).

2.10 Flow cytometry

hGFs isolated according to the procedures described previously (Section 2.2.7), were split into fluorescence-activated cell sorting (FACS) tubes and washed in 0.5 % v/v FBS in PBS (FACS buffer) before centrifugation at 1500 rpm for 5 min (Heraeus Megafuge 16R Thermofisher Scientific). The pellet was resuspended in residual FACS buffer and then either left unstained or stained with an isotype control antibody or target antibody for 30 min at 4 °C (Table 2.3). The cells were washed in FACS buffer and centrifuged (1500 rpm, Heraeus Megafuge 16R, 5 min). The resulting cell pellets were resuspended

in 300 µl FACS buffer then assessed for antibody staining using a FACScaliber flow cytometer (BD, Oxford, UK) by Professor Steve Todryk (Northumbria University). ≥ 10000 gated events were acquired for each sample and data was collected using CellQuest software (BD). Data analysis was performed using winMDI software. hGFs were gated as shown in Figure 2.4 to remove likely cell debris from further analysis.

2.11 SDS-PAGE and immunoblotting

SDS-PAGE uses an electric current to separate proteins in a polyacrylamide gel according to mass. Once separated the proteins are transferred to a membrane and probed with specific antibodies conjugated to HRP. The membrane is covered with a substrate that when oxidised by HRP results in the emission of light. Proteins of interest are then detected by chemiluminescence at the area of the membrane that corresponds to the proteins known molecular mass.

2.11.1 Cell preparation for SDS-PAGE

hGFs were stimulated in 6 well plates or 25 cm² culture flasks to generate enough protein for detection by immunoblotting. At selected time-points post stimulation (0 - 4 h) hGFs were washed in ice-cold PBS and the culture surface aspirated thoroughly to ensure that the lysis buffer was not diluted. Next, 100 µl (6-well plate) or 130 µl (T25) lysis buffer (50 mM TRIS/HCl (Melford, Ipswich, UK) pH 7.5, 1 mM ethylene glycol tetraacetic acid, 1 mM EDTA, 1 mM sodium orthovanadate, 10 mM β -glycerol phosphate, 50 mM sodium fluoride, 10 % v/v glycerol, 0.3 % v/v Triton X100, 5 mM sodium pyrophosphate, 1 µM microcystin LR, 1 x complete cocktail inhibitor (Roche, Burgess Hill, UK), 0.1 % v/v β -mercaptoethanol) was added per flask while on ice. This lysis buffer was based on that used by Hui et al (2012) except the amount of Triton X100 was reduced from 1 % to 0.3 % to eliminate interference with the Bradford assay (Table 2.4). Cells were scraped from the flask into a 1.5 ml centrifuge tube and then incubated on ice for 20 min. Next, the lysates were centrifuged at 15493 x g for 3 min at 4 °C (3K10 centrifuge). The resulting supernatant was transferred to a new ice-cold tube and stored at -80 °C.

2.11.2 Bradford assay

The Bradford assay was used to assess protein concentration in cell lysates. BSA standards (0.4 – 4 µg/well) (Thermofisher Scientific) and a water blank were added to 96-well plates in duplicate and used to generate a standard curve. For sample analysis, cell lysates or lysis buffer as a control, were diluted in water (final volume 10 µl) and

added to 96-well plates in duplicate. Bradford assay reagent (Pierce, Thermo Scientific) (150 µl/well) was added, mixed, and the plates were incubated for 5 min at RT. Absorbance at 595 nm was assessed using a Synergy HT plate reader.

The blank absorbance was subtracted from all samples and standards. The mean readings for each standard concentration were used to generate a 4PL curve fit (Figure 2.5). Samples with a CV > 10 % were repeated. Protein concentrations in samples were determined from the standard curve and used to normalise the concentration between lysates. Subsequently, samples were diluted in sample buffer (0.52 M TRIS, 0.16 M sodium dodecyl sulphate (SDS), 33 % v/v glycerol, 0.03 % w/v bromophenol blue, 17 % v/v β-mercaptoethanol) at a ratio of 4:1. Next, diluted samples were boiled for 5 min to promote protein denaturation and reduction, and then stored at -20 °C.

2.11.3 SDS-PAGE and immunoblotting

Polyacrylamide gels (10 %) were cast (Separating gel: 350mM Tris-base pH 8.8, 0.1 % w/v SDS, 10 % v/v bis/acrylamide (NBS Biologicals, Huntingdon, UK), 0.2 % w/v ammonium persulphate (APS), 3 % v/v tetramethylethylenediamine (TEMED)). Stacking gel (125 mM Tris-base pH 6.8, 0.1 % w/v SDS, 4.5 % v/v bis/acrylamide, 0.1 % APS, 2 % v/v TEMED) was cast on top of the separating gel and combs were inserted. Once set, samples (≤ 20 µg and equal volume for each sample per gel) or PAGERuler prestained protein ladder (5 µl) (Thermo Scientific) were loaded onto the gel. Gels were placed in a tank (Mini-PROTEAN Tetra Cell system, Bio-Rad) and submerged in electrophoresis running buffer (25 mM Tris-base, 200 mM glycine, 1 % w/v SDS). Electrophoresis was performed at 100 V while samples moved through the separating gel, and then increased to 150 V until sufficient separation was achieved. Next, the proteins were transferred from the gel to nitrocellulose membranes using a 7 min pre-programmed blotting protocol using the iBlot gel transfer device (Invitrogen, Life Technologies) according to the manufacturer's instructions.

After transfer membranes were washed in methanol (Thermo Fisher Scientific) and rinsed in water. The membranes were then blocked (5 % w/v non-fat dry milk powder (Marvel, Premier Foods, St. Albans, UK) in TBS/Tween-20 (TBS/T) (150 mM NaCl, 10 mM Tris/HCl pH 7.5, 0.1 % v/v Tween-20)) for 1 h at RT. Blocking buffer was removed by washing in TBS/T (3 x 5 min) before membranes were incubated with primary antibody (diluted in 5 % w/v BSA, 0.02 % w/v sodium azide in TBS/T) for 18 h at 4 °C (Table 2.5). Primary antibody solution was washed from the membranes using

TBS/T (3 x 5 min) and then membranes were incubated for 1 h at RT with HRP-conjugated secondary antibody (diluted in 5 % w/v non-fat dry milk powder, 0.02 % w/v sodium azide in TBS/T) with specificity for the species the primary antibody was raised in (Table 2.5). Excess secondary antibody was removed by washing the membranes in TBS/T (3 x 5 min) before the western blots were developed using enhanced chemiluminescence (ECL) Western blotting detection reagent (GE Healthcare, Hatfield, UK), Immobilon Western chemiluminescent HRP substrate (EMD Millipore, Watford, UK) or ECL Select Western blotting detection reagent (GE Healthcare). Band detection and image acquisition were performed using a Chemigenius II Bioimager (Syngene). Where required, antibodies were stripped from the membranes by washing for 30 min (3x) in 100 mM glycine, pH 2 heated to boiling point.

2.12 GAG assay

This assay compares the amount of GAG in tissue pieces to that of the tissue supernatant which gives an indication of ECM GAG degradation. This simple assay is based on that of Farndale et al (1986) using the dye dimethyl-methylene blue (DMB). Cationic DMB binds highly negatively charged sulphated GAGs. DMB is metachromatic and this binding causes a colour change that can be measured by spectrophotometry.

2.12.1 GAG assay procedure

Chondroitin 4-sulphate standards were prepared at concentrations between 0 - 40 µg/ml in 0.1 M phosphate buffer (Section 2.2.9.1 for buffer details). DMB reagent was prepared by adding 16 mg DMB to a solution of 40 mM glycine, 40 mM NaCl in 10 mM HCl, pH3. DMB reagent was stored at RT away from direct light. The absorbance of the DMB reagent at 525 nm should be approximately 0.3 (Farndale *et al.*, 1986). To confirm this, DMB (250 µl) was dispensed into 4 wells of a 96-well plate and the mean absorbance at 525 nm was measured to be 0.25 using a plate reader.

Gingival tissue digests (Section 2.2.9.1) or tissue supernatants (diluted in 0.1 M phosphate buffer as required) and standards were dispensed into a 96-well plate in duplicate (40 µl/well). DMB reagent (250 µl) was dispensed into each well and the absorbance at 525 nm was read immediately. Background absorbance was subtracted from each well. A linear standard plot was generated from the standards which was subsequently used to calculate the concentrations of GAG in samples (taking account of

any dilutions) (Figure 2.6). These concentrations were used to determine the amount of GAG in the original supernatant or tissue digest. Results are reported as % GAG release calculated using the formula:

$$\left(\text{GAG in supernatant } (\mu\text{g}) \div \text{total GAG } (\mu\text{g})(\text{supernatant} + \text{tissue}) \right) \times 100$$

2.13 Hydroxyproline assay

Hydroxyproline is an unusual amino acid formed by the hydroxylation of proline, is found almost exclusively in collagen, and therefore, hydroxyproline residues released from tissue indicate that collagen fibrils have been proteolytically cleaved (Gorres and Raines, 2010). Hydroxyproline levels are therefore used as a way of assessing relative collagen concentrations. This assay compares the amount of hydroxyproline in tissue pieces to that of the tissue supernatant, which gives an indication of collagen release from the tissue, most likely caused by collagenase activity. To analyse hydroxyproline, proteins must first undergo hydrolysis to release individual amino acids into solution. Hydroxyproline is then oxidised to form a pyrrole. This pyrrole interacts with the organic molecule 4-(dimethylamino)benzaldehyde (DAB) to form a coloured product that can be measured by spectrophotometry. This assay is based on the method of Bergman and Loxley (1963).

2.13.1 Acid hydrolysis of gingival tissue digests and supernatants

Digested gingival tissue and tissue supernatants (120-260 μl) were mixed with an equal volume of concentrated HCl in a deep-well 96 well plate. The sample/HCl mixtures were sealed thoroughly and incubated for 4 – 18 hours at 105 °C in an oven (LTE Scientific, Oldham, UK). HCl donates a proton which promotes peptide bond cleavage. Over time, this results in a mixture containing single amino acids.

Once hydrolysis was complete, the samples were briefly cooled and then the liquid was removed using an aqueous solvent protocol on the EZ-2 centrifugal evaporator (Genevac, Ipswich, UK) for ≥ 7 hours at a temperature of 55 °C. Dried samples were resuspended in dH₂O and the samples were centrifuged (CR3i multifunction centrifuge) briefly to pellet any insoluble material.

2.13.2 Hydroxyproline assay

L-hydroxyproline standards were prepared at concentrations between 0 - 30 $\mu\text{g/ml}$. Standards or hydrolysed samples (40 μl diluted in dH₂O if required) were dispensed in duplicate into a 96-well plate. Chloramine T (250 mM, prepared fresh daily) was diluted

5-fold in acetate-citrate buffer (420 mM sodium citrate, 128 mM trisodium citrate, 26 mM citric acid and 38.5 % v/v propan-2-ol), and then 25 µl was added per well. Reaction mixtures were incubated at RT for 4 minutes. DAB (4.5 M in 70 % v/v perchloric acid) was diluted 4-fold in propan-2-ol and then 150 µl was added per well. The plate was sealed well and incubated at 65 °C for 35 min in an oven. The plate was then cooled briefly, before absorbance at 560 nm was detected using a plate reader.

Background absorbance (dH₂O) was subtracted from each well. A linear plot was generated from the standards and was subsequently used to calculate the unknown concentrations of hydroxyproline in samples (taking account of any dilutions) (Figure 2.7). These concentrations were used to determine the amount of hydroxyproline in the acid hydrolysis reaction. This value was used to calculate the amount of hydroxyproline in the original supernatant or tissue digest. Results are reported as % hydroxyproline release calculated using the formula:

$$\left(\text{OHP in supernatant } (\mu\text{g}) \div \text{total OHP } (\mu\text{g})(\text{supernatant} + \text{tissue}) \right) \times 100$$

2.14 MMP activity assay

This assay for MMP activity is based on the method of Neumann et al (2004). The FS-6 substrate is a 9 amino acid peptide which contains a site that is cleaved by multiple MMPs. The fluorophore (7-methoxycoumarin-4yl)acetyl is bound to the C-terminal of the substrate with an internal dipicolinic acid quencher on the N-terminal side of the cleavage site. Therefore, before cleavage, fluorescence is quenched due to FRET. After substrate cleavage the fluorophore is no longer quenched and fluorescence can be detected and quantified.

The MMP substrate was dissolved in dH₂O at a concentration of 5 mM and stored in aliquots at -20 °C. The fluorophore 7-amino-4-methylcoumarin (AMC) was dissolved in methanol at a concentration of 5 mM and stored at -20 °C. When needed, this MMP substrate stock was diluted to 250 µM in assay buffer (100 mM TRIS, 100 mM NaCl, 10 mM CaCl₂, 0.1% (w/v) PEG6000, 0.05% (w/v) Brij 35). Similarly, AMC was diluted to a working concentration of 25 µM in assay buffer.

The total assay volume was 100 µl in 96-well format and 30 µl in 384-well format opaque black microtitre plates. In the 384-well format assay 1.5 – 6 µl of neat test sample (hGF or gingival tissue supernatant) was dispensed per well. The test sample was diluted in assay buffer to a volume of 24 µl/well. Then 6 µl of 250 µM MMP

substrate was added per well (final concentration: 50 μ M). This mixture was incubated at 37 °C to promote MMP activity and substrate cleavage. In this study incubation times of between 0 – 4 h were assessed. Fluorescence was measured using a plate reader (Excitation 310 nm, Emission 420 nm). In the 96-well format assay the volumes of sample and MMP substrate were increased by 3.33-fold to account for the increased total assay volume per well.

Several controls were performed in each assay; a blank (assay buffer only), a control for background substrate fluorescence (50 μ M substrate, no sample), and a positive control (5 μ M AMC). 5 μ M AMC gives a fluorescence reading that would be expected for 10% degradation of the substrate as the substrate is used at a final concentration of 50 μ M. The endpoint of the assay should be timed so that substrate fluorescence does not exceed that of the AMC control to ensure an excess of substrate for MMPs to target.

This assay can be adapted to measure total MMP activity by incubating samples in the presence of 4-aminophenylmercuric acetate (APMA). Where used, APMA was dissolved at a concentration of 100 mM in DMSO, and spiked into the sample/substrate mixture to give a final concentration of 1 mM.

In preliminary experiments, fluorescence was measured at different sensitivities. Assay buffer (blank control), 50 μ M substrate or 5 μ M AMC were dispensed in duplicate into a 96-well plate (100 μ l/well) or 384-well plate (30 μ l/well). Plates were incubated for 30 minutes at 37 °C and fluorescence was measured using a plate reader (BioTek). The 384-well format was adopted at a sensitivity of 120 (Table 2.6). Using this protocol, the assay had a low % CV, the greatest range between the background substrate fluorescence and the AMC control, and required less reagent/sample volume.

Recombinant human MMP-1 was spiked (100 pg) into assay buffer and tissue culture medium in the presence of APMA. After a 2 h incubation significant MMP activity could be detected in both spiked assay buffer and tissue culture medium confirming that this assay can measure MMP activity (Figure 2.8).

2.15 Statistical analysis

Experiments were performed at least in triplicate unless indicated otherwise, and each experiment was repeated in at least three different hGF donors. SPSS 15.0 (IBM, Portsmouth, UK) was used for statistical analysis. Statistical analysis of real-time RT-PCR data was performed on δ Ct values as previously described (Yuan *et al.*, 2006).

Means + SD, or medians \pm interquartile range are presented depending on whether the datasets had parametric or non-parametric distributions respectively. This was assessed by using the Shapiro-Wilk test for normality and the Levene test for homogeneity of variance. Parametric data were analysed using the Student's t test, while non-parametric data were analysed using the Mann Whitney U test as indicated in the results. Both tests were performed with the Bonferroni-Holm correction for multiple comparisons. Differences were considered significant if $p < 0.05$ for all experiments except for the Illumina microarray data analysis where $p < 0.01$ was required for significance (Section 2.8.2). Only selected comparisons are shown for clarity.

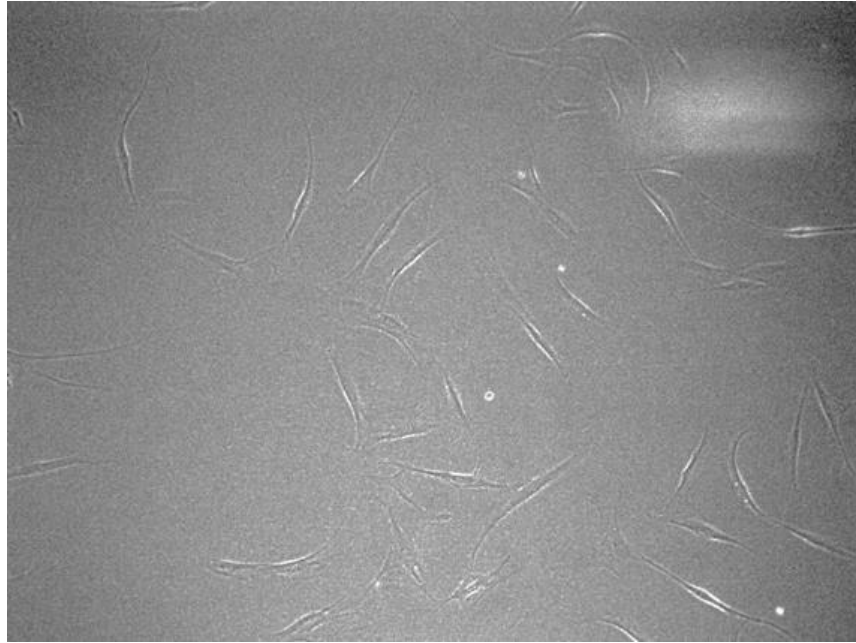
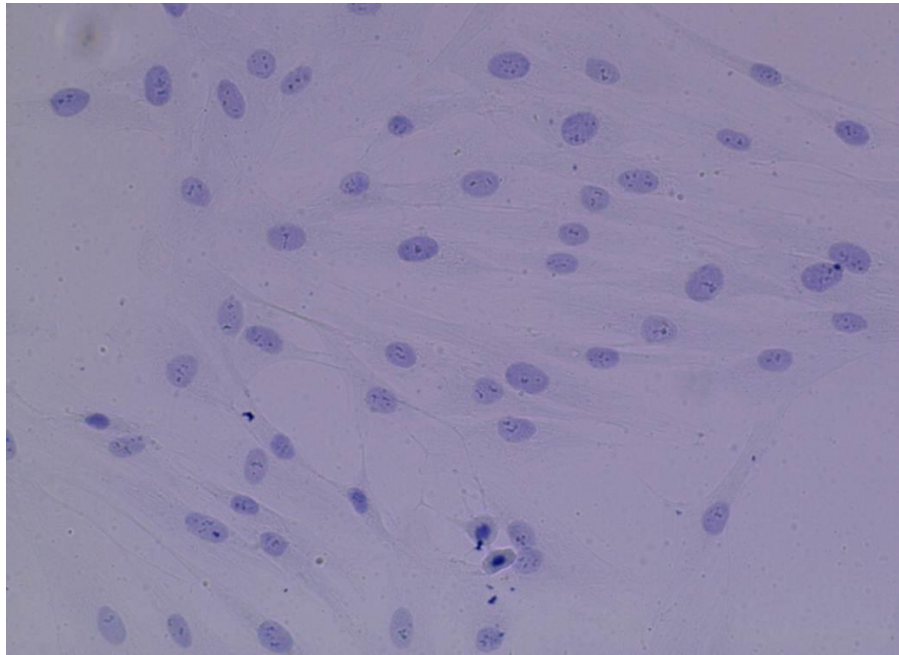

Figure 2.1: hGFs *in vitro*

Primary hGFs were isolated from gingival tissue by outgrowth. hGFs were maintained in DMEM+ in plastic culture flasks. Once confluent, hGFs were subcultured and seeded into new flasks at a lower cell density. This image was taken using a CKX41 light microscope and displays viable hGFs at a low confluency at passage 9. At low confluency the characteristic spindle-shaped morphology of fibroblasts is evident. 100x magnification.

[A]



[B]

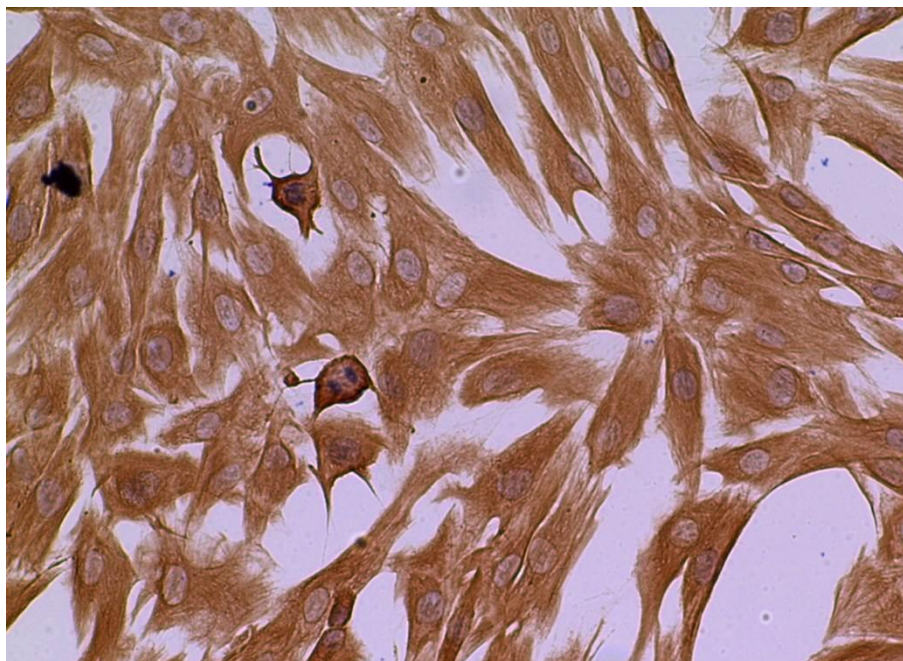

Figure 2.2: hGFs are vimentin positive.

hGFs were cultured on glass slides until confluent. Cells were fixed and stained for vimentin by immunocytochemistry (Section 2.3). Stained samples were mounted onto microscope slides and visualised by light microscopy [A] No antibody control [B] anti-vimentin antibody. Data presented is from one donor and representative of the three donors tested independently. Immunocytochemistry was performed in duplicate for each donor. Images are at x200 magnification.

Table 2.1: A summary of the plastic-ware formats, seeding densities and endpoints used throughout this study.

Seeding densities were chosen to ensure sufficient cell numbers to prevent apoptosis, but with enough space on the growing surface to allow for cell attachment and growth. RT-PCR – reverse transcription PCR, ELISA – enzyme-linked immunosorbant assay.

Plastic-ware format	Seeding density (cells/well or flask)	Maximum volume/surface	Endpoints
96 well plate	$0.3-1.4 \times 10^4$	200 μ l	real-time/conventional RT-PCR proliferation assay ELISA
6 well plate	$1-2 \times 10^5$	2 ml	conventional RT-PCR ELISA immunoblotting microarray
24 well plate	4×10^4	800 μ l	immunocytochemistry
25 cm² cell culture flask	$2-4 \times 10^5$	2.8 ml	immunoblotting

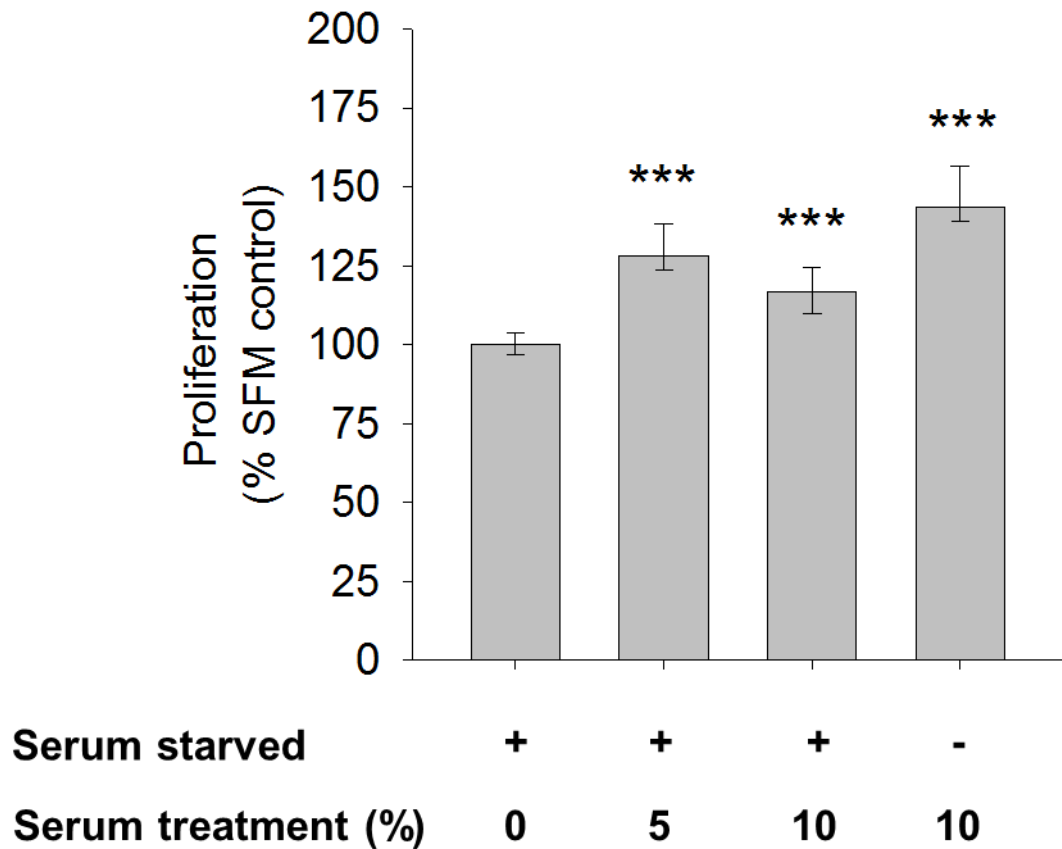

Figure 2.3: The effect of serum on hGF proliferation.

Seeded hGFs incubated in DMEM+ were washed in PBS. PBS was replaced with either SFM (serum starved) or DMEM+ and hGFs were incubated overnight (18 h). hGFs were then either maintained in SFM or DMEM+, or SFM was replaced with DMEM supplemented with 5 or 10 % FBS. hGFs were incubated for a further 24 h at which time proliferation was assessed by a colourimetric proliferation assay. Data (median±IQR, n=10-41 from 11 independent experiments in 5 different donors) are presented as % SFM-treated control. Statistics: Mann Whitney U test for independent samples (Bonferroni-corrected). ***=p<0.001 compared to SFM-treated control. SFM – serum-free medium.

Table 2.2: The forward and reverse primer and probe sequences used for RT-PCR analysis of gene expression.

Primers and probes were aliquoted and stored at -20 °C. β 2m – β 2-microglobulin, LEPR – leptin receptor (long isoform).

Gene	Forward	Reverse	Probe	Product size
MMP-1	5'-AAGATGAAAGGTGGACCAAAATT-3'	5'-CCAAGAGAATGGCCGAGTTC-3'	5'-FAM-CAGAGAGTACAACCTTACATCGTGTGCGGCTC-TAMRA-3'	
MMP-2	5'-TGGCGATGGATAACCCCTTT-3'	5'-TTCTCCCAAGGTCCATAGCTCAT-3'	5'-FAM-CTCCTGGCTCATGCCTTCGCCC-TAMRA-3'	
MMP-3	5'-TTCCGCCTGTCTCAAGATGATAT-3'	5'-AAAGGACAAAGCAGGATCACAGT T-3'	5'-FAM-TCAGTCCCTCTATGGACCTCCCCCTGAC-TAMRA-3'	150 bp
MMP-7	5'-CTTTGCGCGAGGAGCTCA-3'	5'-CAGGCGGAAAGGCATGA-3'	5'-FAM-CCATTTGATGGGCCAGGAAACACG-TAMRA-3'	
MMP-8	5'-CACTCCCTCAAGATGACATCGA-3'	5'-ACGGAGTGTGGTGATAGCATCA-3'	5'-FAM-CAAGCAACCCTATCCAACCTACTGGACCAA-TAMRA-3'	
MMP-9	5'-CCTGGGCAGATTCCAAACCT-3'	5'-GCAAGTCTTCCGAGTAGTTTTGGA T-3'	5'-FAM-CTCAAGTGGCACCACCACAACATCACC-TAMRA-3'	
MMP-10	5'-GGACCTGGGCTTTATGGAGATAT-3'	5'-CCCAGGGAGTGGCCAAGT-3'	5'-FAM-CATCAGGCACCAATTTATTCCTCGTTGCT-TAMRA-3'	
MMP-12	5'-CGCCTCTCTGCTGATGACATAC-3'	5'-GGTAGTGACAGCATCAAACTCAA A-3'	5'-FAM-TCCCTGTATGGAGACCCAAAAGAGAA CCA-TAMRA-3'	
MMP-13	5'-AAATTATGGAGGAGATGCCATT-3'	5'-TCCTTGAGTGGTCAAGACCTAA-3'	5'-FAM-CTACAACCTGTTTCTTGTTGCTGCGCATGA-TAMRA-3'	
MMP-14	5'-AGGCCGACATCATGATCTTCTTT-3'	5'-AAGTGGGTGTCTCCTCCAATGTT-3'	5'-FAM-CCATGGCGACAGCAGCCCTT-TAMRA-3'	
TIMP-1	5'-GACGGCCTTCTGCAATTCC-3'	5'-GTATAAGGTGGTCTGGTTGACTTC TG-3'	5'-FAM-ACCTCGTCATCAGGGCCAAGTTCGT-TAMRA-3'	
TIMP-2	5'-GAGCCTGAACCACAGGTACCA-3'	5'-AGGAGATGTAGCACGGGATCA-3'	5'-FAM-CTGCGAGTGCAAGATCACGCGC-TAMRA-3'	
18S rRNA	5'-CGAATGGCTCATTAAATCAGTTATG G-3'	5'-TATTAGCTCTAGAATTACCACAGT TATCC-3	5'-FAM-TCCTTTGGTCGCTCGCTCCTCTCCC-TAMRA-3'	85 bp
LEPR	5'-GAAGATGTTCCGAACCCCAAGAATT G-3'	5'-CTAGAGAAGCACTTGGTGACTGAA C-3'		428 bp
β 2m	5'-ACCCCACTGAAAAAGATGA-3'	5'-CTTATGCACGCTTAACTATC-3'		425 bp

Table 2.3: Details of the antibodies used for flow cytometry.

PE – phycoerythrin, APC - allophycocyanin, TLR – Toll-like receptor. EBioscience, Hatfield, UK; AbD Serotec, Kidlington, UK

Target	Fluorophore	Clone	Isotype	Species	Supplier
Leptin receptor	PE	52263	IgG2B	Mouse	R&D systems
Isotype control	PE	133303	IgG2B	Mouse	R&D systems
TLR2	APC	TL2.1	IgG2A	Mouse	EBioscience
TLR4	APC	HTA125	IgG2A	Mouse	EBioscience
Isotype control	APC	MRC OX-34	IgG2A	Mouse	AbD Serotec

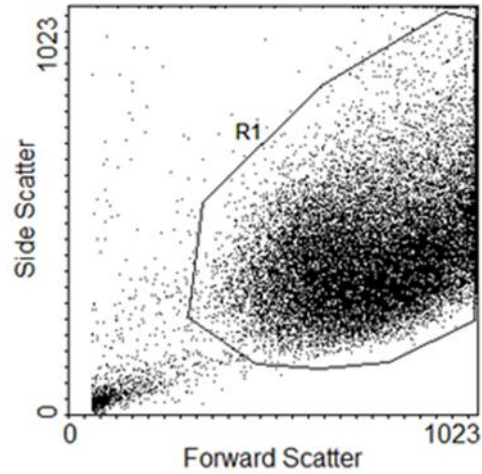

Figure 2.4: Forward and side scatter properties of hGFs.

hGFs were prepared for flow cytometry (Section 2.2.7). Forward and side scatter were assessed on unstained cells according to the methods, and this data is presented in dot plots. The region highlighted in this dot plot was used to gate cells and omit cellular debris.

Table 2.4: Absorbance values derived from the Bradford assay.

Cell lysis buffer with two different concentrations of Triton X100 or Triton X100 alone (at concentrations of 5 – 0.1 %) were used as samples for the Bradford assay (Section 2.11.2). Data (n=2-4) shows absorbance values measured at 595 nm which had the background absorbance (from a water blank) subtracted.

	Triton X100 (%)	Mean absorbance (595 nm - blank)
Lysis buffer	1	0.175
	0.3	0.002
Triton X100	5	> top standard
	2	> top standard
	1	0.191
	0.3	0.008
	0.1	0.001

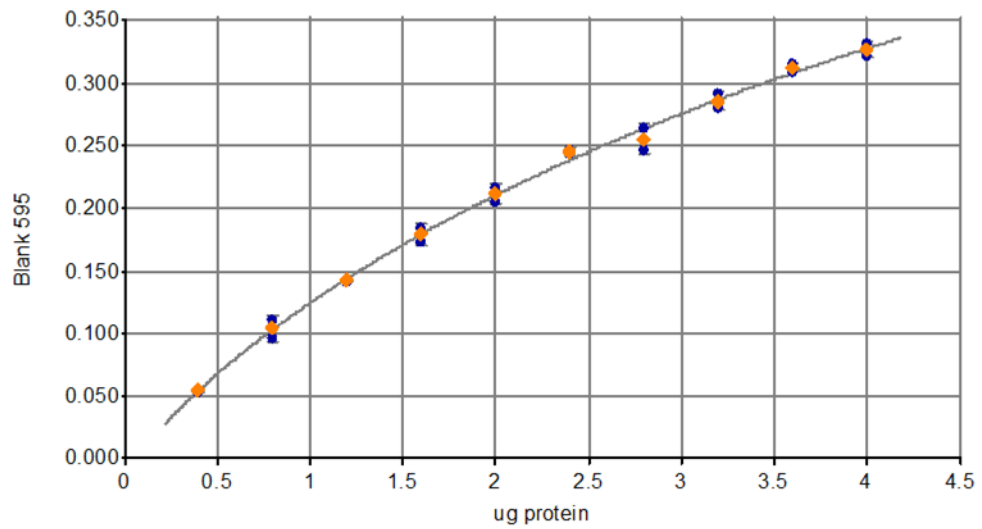

Figure 2.5: Representative standard curve for the Bradford assay.

Blank-subtracted absorbance (blank 595 nm) was plotted against standard protein (BSA) concentrations (0 – 4 $\mu\text{g}/\text{well}$, $n=2$ per concentration). A 4-parameter logarithmic curve was fitted and used to determine the unknown concentration of proteins in samples.

Table 2.5: Targets, species of origin, dilutions and suppliers for antibodies used in this study.

The site/s of phosphorylation in the phospho-epitopes detected by the antibodies used in this study are displayed in brackets using the single letter amino acid code to indicate the amino acid type, and a number which indicates how far downstream of the translation initiating methionine this amino acid residue is found in the protein (e.g. for ERK, T202 represents the amino acid threonine at position 202 in this protein). GAPDH – Glyceraldehyde-3'-phosphate dehydrogenase, JNK – c-Jun N-terminal kinase, SAPK – stress-activated protein kinase. Cell Signaling Technology, New England Biolabs, Hitchin, UK

Target (phosphorylation site/s)	Species	Dilution	Manufacturer
Phospho-p44/42 MAPK (pERK1/2) (T202/Y204)	Rabbit	1:1000	Cell Signaling Technology
Phospho-SAPK/JNK (T183/Y185)	Rabbit	1:1000	Cell Signaling Technology
Phospho-p38 MAPK (T180/Y182)	Rabbit	1:1000	Cell Signaling Technology
Phospho-STAT3 (Y705)	Rabbit	1:1000	Cell Signaling Technology
Phospho-STAT3 (S727)	Rabbit	1:1000	Cell Signaling Technology
Phospho-STAT1 (Y701)	Rabbit	1:1000	Cell Signaling Technology
Phospho-STAT1 (S727)	Rabbit	1:1000	Cell Signaling Technology
Phospho-STAT5 (Y694)	Rabbit	1:1000	Cell Signaling Technology
Phospho-AKT (S473)	Rabbit	1:1000	Cell Signaling Technology
Phospho-AKT (T308)	Rabbit	1:1000	Cell Signaling Technology
Phospho-p65 (S536)	Rabbit	1:1000	Cell Signaling Technology
GAPDH	Mouse	1:5000	Millipore
p44/42 MAPK	Rabbit	1:1000	Cell Signaling Technology
STAT3	Rabbit	1:1000	Cell Signaling Technology
Polyclonal anti-rabbit	Goat	1:2000	Dako
Polyclonal anti-mouse	Goat	1:5000	Dako

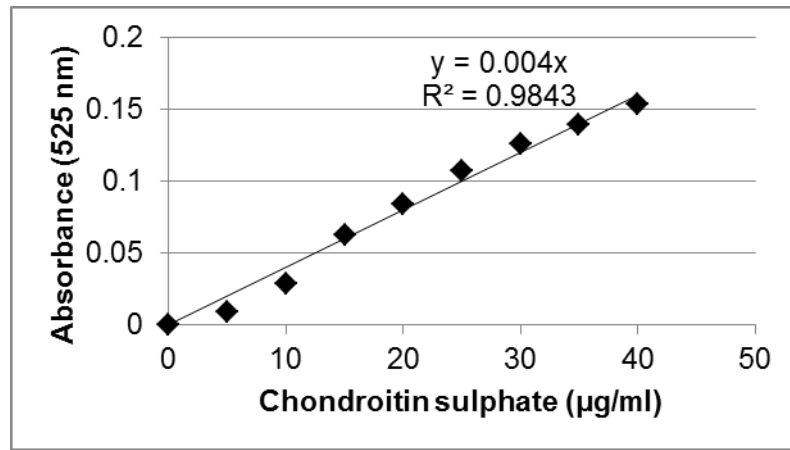

Figure 2.6: A representative standard plot for the GAG assay.

The mean blank-subtracted absorbance at 525 nm was plotted against chondroitin sulphate standard concentrations (0 – 40 µg/ml, n=2 per concentration). A linear trend line was fitted. The equation of the trend line and the R^2 value are also displayed.

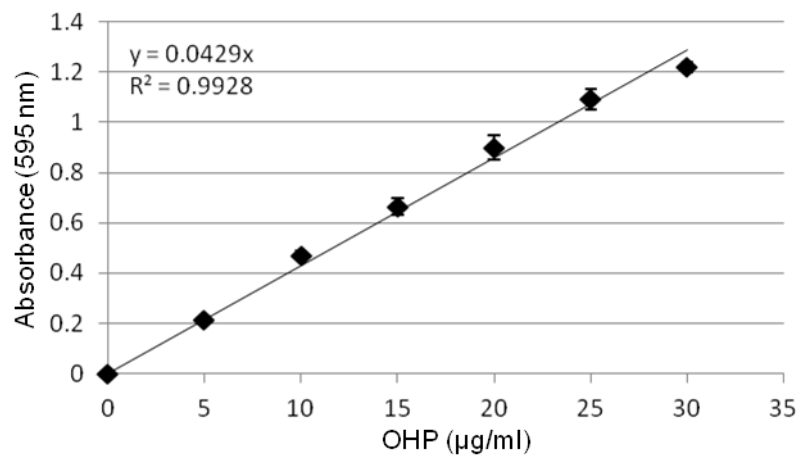

Figure 2.7: Representative standard plot for the hydroxyproline assay.

Blank-corrected absorbance (595 nm: mean+SD n=2) was plotted against standard hydroxyproline (OHP) concentrations (0 – 30 µg/ml). A linear trend line was fitted and used to determine the unknown concentration of hydroxyproline in samples. The equation of the trend line and the R^2 value are also displayed.

Table 2.6: Comparison of FS6 assay controls at different sensitivities.

Relative fluorescence units (RFU) measured in the blank, substrate and AMC controls are displayed in this table at sensitivities between 35-120 (excitation 310 nm, emission 420 nm). The mean RFU (n=2) and % CV are displayed for both 96- and 384- well plate assay formats. The fold difference between the substrate and AMC control is presented as an indication of the dynamic range of the assay. ND – not done.

			RFU					
			96-well			384-well		
			Mean	% cv	Range (fold substrate)	Mean	% cv	Range (fold substrate)
Sensitivity	35	Blank	0	0	1.8	ND		
		Substrate	2.5	28				
		AMC	4.5	47				
	70	Blank	119	7	3.1	ND		
		Substrate	133	1				
		AMC	417	1				
	95	Blank	857	6	3.3	65	0	4.9
		Substrate	1050	2		439	2	
		AMC	3540	1		2190	9	
	120	Blank	5160	10	3.4	256	1	5.1
		Substrate	5950	1		2460	4	
		AMC	20600	1		12600	8	

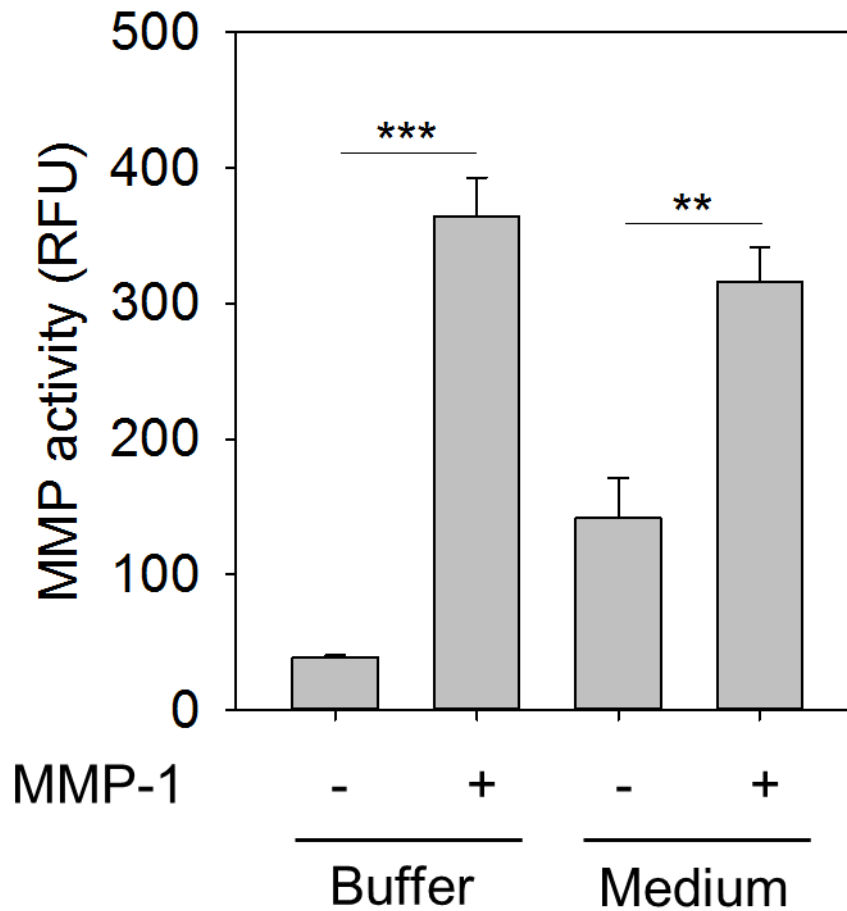

Figure 2.8: MMP activity in spiked assay buffer and tissue culture medium.

Recombinant human MMP-1 was spiked into MMP activity assay buffer or serum-free medium to result in 100 μg MMP-1/well. APMA was added to MMP-1-containing wells to activate the recombinant MMP-1 and samples were then incubated with the MMP substrate FS-6 for 2 h at 37 $^{\circ}\text{C}$. Fluorescence was measured (excitation 310 nm, emission 420 nm). Data (RFU) are presented as mean+SD (n=2-4). Statistics: T tests for independent samples (Bonferroni-corrected) ***=p<0.001, **=p<0.01 as indicated.

3 Chapter 3. Regulation of MMP and TIMP production by gingival fibroblasts stimulated with leptin

3.1 Introduction

Leptin has a broad range of functions, including regulating energy expenditure, reproductive capability and immunocompetence (Myers *et al.*, 2008). Leptin appears to regulate these functions both by signalling to the CNS, and by signalling directly to peripheral cells (Mantzoros *et al.*, 2011). One of the peripheral outcomes of leptin signalling is a change in cellular phenotype relevant to tissue remodelling (Schram *et al.*, 2010). Leptin decreases the production of the collagenase MMP-1 in HSCs (Cao *et al.*, 2007), but increases MMP-1 production in cartilage and chondrocytes (Koskinen *et al.*, 2011; Hui *et al.*, 2012). Similarly, leptin increases the expression of the MMP inhibitor TIMP-1 in HUVECs (Park *et al.*, 2001), but decreases TIMP-1 expression in a murine cardiomyocyte cell line (Schram *et al.*, 2010). These conflicting results are likely due to the different cells and tissues assessed, and the concentrations of leptin used. Several studies report that leptin increases the production of the collagenase MMP-13 in glioma cells, cartilage and chondrocytes (Yeh *et al.*, 2009; Koskinen *et al.*, 2011; Hui *et al.*, 2012). Only one study has attempted to investigate whether leptin regulates the production of the collagenase MMP-8 (Koskinen *et al.*, 2011), but no MMP-8 was detected in any of the human osteoarthritis cartilage samples used, suggesting that leptin cannot induce MMP-8 in this tissue. Several studies have reported that leptin increases the expression, secretion and activity of the gelatinases (MMP-2/9) in HUVECs (Park *et al.*, 2001), a breast cancer cell line (McMurtry *et al.*, 2009), a cardiomyocyte cell line (Schram *et al.*, 2010), and cardiac fibroblasts (Schram *et al.*, 2011). In contrast, leptin has no effect on MMP-2 and MMP-9 expression and activity in a glioma cell line (Yeh *et al.*, 2009). Increased production of the stromelysin MMP-3 and the membrane-type MMP-14 is also stimulated by leptin (Koskinen *et al.*, 2011; Schram *et al.*, 2011). Overall, these studies support a role for leptin in regulating ECM remodelling. However, only one of these studies was performed in fibroblasts, and this study used fibroblasts derived from rats (Schram *et al.*, 2011). There are no reports on the ability of leptin to regulate MMP and TIMP production by human fibroblasts.

Fibroblasts sense and respond to stimuli in the gingival microenvironment (Bartold and Narayanan, 2006). Gingival fibroblasts regulate gingival tissue integrity, particularly by altering the production of MMPs and TIMPs (Ebisawa *et al.*, 2011). Dysregulated tissue

remodelling occurs in periodontitis (Preshaw, 2008), and therefore, gingival fibroblasts are implicated in the disease pathogenesis. *In vitro* experiments have shown that primary hGFs produce MMP-1 constitutively (Yamada *et al.*, 2000; Domeij *et al.*, 2002). *In situ* hybridisation and IHC approaches showed that MMP-13 localises to fibroblasts (among other cells) within the gingiva of individuals with periodontitis (Tervahartiala *et al.*, 2000). However, in this study no healthy gingival tissue was used as a control, so it is unclear whether MMP-13 is also present in healthy gingiva. Similarly, MMP-8 protein is produced by gingival fibroblasts isolated from individuals with chronic periodontitis (Cox *et al.*, 2006); again no healthy control fibroblasts were used for comparison. The production of MMP-1 and MMP-13 by hGFs is increased by a variety of cytokines and growth factors (Domeij *et al.*, 2002; Leivonen *et al.*, 2002; Cox *et al.*, 2006; Cury *et al.*, 2007; Ujii *et al.*, 2012). Interestingly, Domeij *et al.* (2002) identified that increased MMP-1 gene expression is initially observed at a time point of 8 h, and is maintained up to 48 h (the longest time point tested). This suggests that gingival fibroblasts, unlike neutrophils which store pre-synthesised MMP protein in intracellular granules (Birkedal-Hansen, 1993), increase the production of MMPs in a manner that requires the immediate early synthesis of transcription factors which bind to MMP promoters to increase gene expression (Sorsa *et al.*, 2006).

Gingival fibroblasts isolated from individuals with periodontitis produce MMP-2 mRNA and protein (Dahan *et al.*, 2001; Cox *et al.*, 2006). Stimulation of hGF with bacteria, bacterial supernatants and LPS mildly increases the production of MMP-2 (Dahan *et al.*, 2001; Zhou and Windsor, 2006; Bodet *et al.*, 2007; Zhang *et al.*, 2011), while growth factors and nicotine have no similar effect (Cury *et al.*, 2007; Zhou *et al.*, 2007; Zhang *et al.*, 2011; Ujii *et al.*, 2012). MMP-2 is not highly regulated at the level of gene expression, and these studies suggest that this is true for gingival fibroblasts (Birkedal-Hansen, 1993). Interestingly, *P. gingivalis* supernatant and TNF- α increase the amount of active MMP-2 produced by hGFs. Also, TNF- α induces the expression of MMP-9 in rat gingival fibroblasts (Kim *et al.*, 2009).

The stromelysins MMP-3 and MMP-10 are expressed in unstimulated hGFs (Domeij *et al.*, 2002; Mah *et al.*, 2014). Using IHC, MMP-3 was found to localise to fibroblasts in the gingiva of individuals with periodontitis (Beklen *et al.*, 2006). Cytokines, PGE₂, and LPS regulate the production of MMP-3 by hGFs, generally enhancing MMP-3 production (Domeij *et al.*, 2002; Ruwanpura *et al.*, 2004; Bodet *et al.*, 2007; Cury *et al.*, 2007). Beklen *et al.* (2006) found that TNF- α -stimulated hGFs increase the production

of inactive or pro-MMP-3, and suggested that the activation of MMP-3 requires proteases from exogenous sources. In support of this, *P. gingivalis* culture supernatant (which contains numerous potent proteases) has no effect on MMP-3 gene expression in hGFs, but increases the amount of active MMP-3 (Zhou and Windsor, 2006).

The matrilysin MMP-7 is localised to fibroblasts in the gingiva of individuals with periodontitis (Tervahartiala *et al.*, 2000). Increased gene expression and protein levels of MMP-7 are detected in hGFs stimulated with epidermal growth factor (EGF) (Cury *et al.*, 2007). Similarly, EGF increases the expression of the elastase MMP-12 by hGFs (Zhou and Windsor, 2006).

MMP-14 is produced by gingival fibroblasts isolated from individuals with periodontitis (Dahan *et al.*, 2001; Cox *et al.*, 2006). Depending on the stimuli tested, both increases and decreases in the production of MMP-14 in gingival fibroblasts have been observed (Zhou and Windsor, 2006; Smith *et al.*, 2009; Zhang *et al.*, 2011); other stimuli have no effect on MMP-14 production (Zhou *et al.*, 2007; Zhang *et al.*, 2011). Both *P. gingivalis* supernatant and nicotine increase the amount of active MMP-14 in hGFs, although the mechanism underlying this effect was not explored (Zhou and Windsor, 2006; Zhou *et al.*, 2007).

The MMP inhibitors TIMP-1, TIMP-2, TIMP-3 and TIMP-4 are produced constitutively by gingival fibroblasts (Yamada *et al.*, 2000; Bodet *et al.*, 2007; Nakasone *et al.*, 2009; Leivonen *et al.*, 2013). TIMP-1 gene expression by hGFs is increased by bacterially-derived molecules (Zhou and Windsor, 2006; Bodet *et al.*, 2007). However, in these studies there are inconsistencies regarding whether the changes in TIMP-1 gene expression translate to protein. Both LPS and nicotine have no effect on the protein levels of TIMP-2 in hGFs (Bodet *et al.*, 2007; Zhou *et al.*, 2007; Zhang *et al.*, 2011), however increased TIMP-2 gene expression is described in hGFs stimulated with *P. gingivalis* supernatant (Zhou and Windsor, 2006). TIMP-2 forms complexes with MMP-14 and MMP-2, and is thought to be important in regulating the activity of MMP-2 at the plasma membrane (Nagase *et al.*, 2006). In support of this, there is some evidence that components of cigarette smoke increase the localisation of TIMP-2 to the surface of hGFs (Zhou *et al.*, 2007; Zhang *et al.*, 2011).

Overall, there is good evidence to suggest that gingival fibroblasts express and secrete a variety of MMPs and TIMPs. Numerous and diverse inflammatory stimuli increase the production of MMPs by gingival fibroblasts; this may be relevant to the ECM

destruction that occurs in periodontitis. Stimuli that bear structural and functional similarities to leptin (e.g. cytokines and growth factors) regulate the production of MMPs in hGFs. Leptin enhances the matrix-degrading potential of several cell types, however no-one has assessed whether leptin has a similar effect on gingival fibroblasts; there is a lack of data on this phenomenon in human fibroblasts and mesenchymally-derived cells in general. Therefore, the aim of the experiments presented in this chapter was to determine whether leptin increases MMP and TIMP expression in hGFs.

3.2 Basal expression of MMPs and TIMPs in gingival fibroblasts

Unstimulated hGFs from up to seven individual donors were lysed and cDNA prepared by reverse transcription. RT-PCR was used to determine the basal mRNA expression levels of MMPs and TIMPs by hGFs (Table 3.1). Regarding the collagenases, MMP-1 and MMP-8 mRNAs were detected in unstimulated hGFs from all donors tested. However, the third collagenase, MMP-13, was not detected in unstimulated hGFs from any donor.

The gelatinase MMP-2 was expressed in unstimulated hGFs derived from 3 donors, while no basal expression of MMP-9 was detected in the donors tested (Table 3.1). The stromelysin MMP-3 was not consistently expressed at a basal level in hGFs; the expression of MMP-3 varied between donors (n=4) and between replicates (n=4 different RNA samples for each donor). Another stromelysin, MMP-10, was expressed basally in the one donor tested.

No basal expression of the matrilysin MMP-7 was detected in hGFs from both donors tested (Table 3.1). In contrast, both the membrane type-MMP MMP-14 and MMP-12 were detected in unstimulated hGFs in all donors tested (n=3). Additionally, the MMP inhibitors TIMP-1, TIMP-2 and TIMP-3 were all expressed in unstimulated hGFs from all donors tested.

3.3 Regulation of MMPs and TIMPs in gingival fibroblasts by leptin

hGFs were stimulated with leptin (0.1 – 25 µg/ml) for 6 – 48 h. hGFs were lysed and cDNA prepared by reverse transcription while the supernatants were collected. RT-PCR was used to determine the relative MMP and TIMP gene expression levels after leptin stimulation. MMP concentrations in the supernatants were assessed by ELISA.

Unstimulated hGFs at each time point were used as controls.

3.3.1 *MMP-1*

Leptin significantly increased MMP-1 mRNA levels in hGFs at 24 h in a dose-dependent manner (Figure 3.1). A 4.4-fold increase in MMP-1 expression was observed in hGFs treated with 10 µg/ml leptin ($p < 0.01$), while an 8.6-fold increase was detected for the 25 µg/ml leptin concentration ($p < 0.001$) compared to the unstimulated control. To determine whether leptin had a similar effect on MMP-1 secretion, MMP-1 concentrations in the supernatants of leptin-stimulated hGFs were assessed at a 24 h time point. In agreement with the MMP-1 gene expression data, secreted MMP-1 levels were also significantly increased by leptin in a dose-dependent manner (Table 3.2). However, the concentrations of MMP-1 detected varied between donors. In one of the donors, MMP-1 was only detected in the supernatants of hGFs that had been stimulated with 10 and 25 µg/ml leptin (Table 3.2). In the other donors, MMP-1 protein was detected in the supernatants of hGFs from all treatment conditions (0 – 25 µg/ml leptin). In these donors the concentrations of MMP-1 detected were significantly higher in supernatants from hGFs stimulated with 10 or 25 µg/ml leptin compared to the unstimulated control, and the lower concentrations of leptin (0.1, 0.5, 1 µg/ml) (all $p < 0.001$). In two of the three donors, the concentrations of MMP-1 detected were significantly higher in supernatants from hGFs stimulated with 25 µg/ml leptin compared to those stimulated with 10 µg/ml leptin (Table 3.2).

Leptin-stimulated MMP-1 gene expression was assessed at two time points (6 and 24 h) to determine how MMP-1 expression in hGFs related to time (Figure 3.2). The levels of MMP-1 gene expression after leptin stimulation (10 µg/ml) in hGFs were significantly higher at 24 and 48 h respectively (both $p < 0.001$) compared to the 6 h time point in the one donor tested. No significant difference between the levels of MMP-1 at 24 h and 48 h after leptin stimulation were detected (Figure 3.2). Additionally, the level of MMP-1 expression after leptin stimulation for 6 h was not significantly different to the unstimulated 6 h control. As MMP-1 gene expression correlated with secreted MMP-1 in cell supernatants previously (as shown in Figure 3.1 and Table 3.2), MMP-1 concentrations were assessed in hGF supernatants at 24 and 48 h time points (Figure 3.3). Secreted levels of MMP-1 were significantly higher for leptin-stimulated hGFs (10 µg/ml) at 24 and 48 h (both $p < 0.001$) compared to the unstimulated control at the same time point. The concentration of MMP-1 detected in 10 µg/ml leptin-stimulated hGF supernatants was significantly higher ($p < 0.001$) at 48 h compared to 24 h (Figure 3.3).

3.3.2 *Other collagenases*

MMP-8 and MMP-13 gene expression were assessed by real-time RT-PCR (Table 3.1). Leptin (10 µg/ml) significantly increased MMP-8 mRNA expression by 2.6-fold compared to the unstimulated control at 24 h ($p < 0.05$). In contrast, MMP-13 mRNA was not detected at any leptin concentration tested (0, 0.1, 0.5, 1, 10, 25 µg/ml) at a 24 h time point in the two donors assessed (Table 3.1).

3.3.3 *Gelatinases*

Although MMP-2 was expressed constitutively (Table 3.1), leptin (0.1 – 25 µg/ml) had no significant effect on MMP-2 mRNA levels in hGFs after a 24 h stimulation (Figure 3.4). Similarly, MMP-9 mRNA, which was not detected basally by hGFs (Table 3.1), was also not detected after stimulation with leptin at any concentration tested (0.1, 0.5, 1, 10, 25 µg/ml) at a 24 h time point in the two donors assessed (using real-time RT-PCR).

3.3.4 *Stromelysins*

MMP-3 mRNA was not consistently detected using real-time RT-PCR in unstimulated hGFs or those stimulated with leptin (0.1 – 25 µg/ml) (Table 3.1), possibly due to transcript levels below the level of detection of the RT-PCR method used in this study. Similar inconsistencies in MMP-3 gene expression have been described in the literature (Domeij *et al.*, 2002; Zhou and Windsor, 2006). Therefore, semi-quantitative RT-PCR was used to assess MMP-3 gene expression (Figure 3.5). Very faint bands of the correct product size for MMP-3 were detected in leptin-stimulated (0.1 and 10 µg/ml) and unstimulated hGFs at a 24 h time point. No clear differences in the intensity of the bands between leptin-stimulated or unstimulated hGFs were identified.

Because of the inability to quantitatively detect MMP-3 mRNA levels, MMP-3 concentrations in hGF supernatants were assessed at a 24 h time point (Table 3.3A). In two of the three donors, MMP-3 was only detected in the supernatants of hGFs that had been stimulated with 25 µg/ml leptin. Interestingly, in a third donor, MMP-3 protein was detected in the supernatants of hGFs from all treatment conditions (0 – 25 µg/ml leptin). In this donor the concentrations of MMP-3 detected were significantly higher in supernatants from hGFs stimulated with 10 or 25 µg/ml leptin compared to the unstimulated control, and the lower concentrations of leptin (0.1, 0.5, 1 µg/ml) (all $p < 0.001$).

MMP-3 concentrations were also assessed at a 48 h time point (Table 3.3B). This was done to identify whether or not MMP-3 secretion increased over time, similar to that observed for MMP-1 (Figure 3.3). In one donor, no MMP-3 was detected at either 24 or 48 h time points under both unstimulated and leptin-stimulated (10 µg/ml) treatment conditions. In the other two donors tested, MMP-3 concentrations were higher in supernatants from leptin-stimulated (10 µg/ml) hGFs compared to the unstimulated controls at 24 h (donor 2: $p < 0.001$, donor 3: $p < 0.01$) and 48 h (both donors $p < 0.001$). Additionally, in both of these donors the levels of leptin-stimulated MMP-3 protein were increased at 48 h compared to 24 h (both donors $p < 0.001$). In donor 2 the levels of MMP-3 detected in supernatants from unstimulated hGFs were significantly higher at 48 h compared to 24 h ($p < 0.05$); no significant difference in unstimulated MMP-3 levels were detected between 24 and 48 h in donor 3.

Gene expression levels (assessed by semi-quantitative RT-PCR) of another stromelysin, MMP-10, appeared to be higher in hGFs after leptin stimulation (0.1 and 10 µg/ml) compared to the unstimulated control at 24 h (Figure 3.6). However, MMP-10 gene expression was only assessed in one donor.

3.3.5 Other MMPs

Gene expression levels of a matrilysin (MMP-7), a membrane-type MMP (MMP-14) and the metalloelastase (MMP-12) were assessed by real-time RT-PCR. MMP-7 mRNA was not detected at baseline nor after stimulation with any leptin concentration tested (0.1, 0.5, 1, 10, 25 µg/ml) at 24 h in the two donors assessed (Table 3.1). Similarly, leptin (10 µg/ml) had no significant effect on MMP-12 mRNA expression ($n=6$ from 3 donors stimulated in independent experiments) compared to the unstimulated control at 24 h (Table 3.1). In contrast, leptin significantly increased MMP-14 mRNA levels in hGFs from 3 donors at 24 h in a dose-dependent manner (Figure 3.7). A 2.6-fold increase in MMP-14 gene expression was detected in hGFs treated with 10 µg/ml leptin ($p < 0.05$) compared to the unstimulated control; no significant difference in MMP-14 gene expression was observed after stimulation with 0.1 µg/ml leptin compared to unstimulated hGFs.

3.3.6 TIMPs

TIMP-2 gene expression was assessed by semi-quantitative RT-PCR (Figure 3.6). Bands of the correct product size for TIMP-2 were detected in leptin-stimulated (0.1 and 10 µg/ml) and unstimulated hGFs at 24 h. The intensity of the band observed for hGFs

stimulated with 10 µg/ml leptin appeared to be fainter than that observed for the unstimulated control or 0.1 µg/ml leptin treatment condition, suggesting that leptin dose-dependently decreases TIMP-2 gene expression. The caveat to this conclusion is that this analysis was only completed in hGFs from a single donor.

TIMP-1 and TIMP-3 gene expression were determined by real-time RT-PCR. Leptin (10 µg/ml) had no significant effect on TIMP-3 mRNA levels (n=12 from 3 donors stimulated in independent experiments) compared to the unstimulated control at 24 h (Table 3.1). Similarly, TIMP-1 mRNA levels in hGFs were not significantly altered by leptin stimulation (0.1 and 10 µg/ml) compared to the unstimulated control (Figure 3.8).

3.3.7 MMP activity

hGF culture supernatants were tested for MMP activity at two dilutions (1.5 or 3 µl sample in a total volume of 30 µl) (Section 2.14). These supernatants were derived from hGFs stimulated for 24 h with leptin (0.1, 0.5, 1 10 and 25 µg/ml) or unstimulated controls. Across all treatment conditions, no fluorescence was detected in hGF supernatants above that of the substrate control, suggesting that unstimulated or leptin-stimulated hGF supernatants contained no measurable MMP activity.

3.4 Proliferative response of gingival fibroblasts to leptin stimulation

Leptin promotes cell proliferation and survival (Farooqi *et al.*, 2002; Saxena *et al.*, 2007; Shan *et al.*, 2008; Mattioli *et al.*, 2009; Fernandez-Riejos *et al.*, 2010; Uddin *et al.*, 2010). Although the use of a reference gene should account for differences in cell proliferation and activity over the course of an experiment, gene expression levels of reference genes can change after stimulation with leptin (Section 2.7.3). This can result in data that does not truly represent the expression levels of the gene of interest. In an effort to confirm whether the changes in MMP production observed in hGFs after leptin stimulation (Section 3.3) were due to non-specific increases in metabolic or cell division rates, a cell proliferation assay was performed.

hGFs were stimulated with leptin (0.1 – 25 µg/ml) for 24 h. Relative levels of cell proliferation were assessed using a tetrazolium compound-based assay (Section 2.5.1). Unstimulated hGFs were used as a negative control. Leptin dose-dependently increased hGF proliferation (Figure 3.9). hGF proliferation was significantly increased 16 % after treatment with 10 µg/ml leptin (p<0.01) and by 20 % after treatment with 25 µg/ml leptin (p<0.001) compared to the unstimulated control. hGF proliferation was increased 45 % in the FBS-stimulated positive control compared to the unstimulated control.

Interestingly, after 24 h stimulation with leptin (10 and 25 $\mu\text{g/ml}$) or IL-1 α (0.05 ng/ml, as a positive control for hGF proliferation) there was a notable change in hGF morphology with high concentration leptin-stimulated cells looking larger than unstimulated cells by visual inspection under light microscopy. This suggests that leptin increases the growth of hGFs, and supports the results of the proliferation assay.

3.5 Discussion

Gingival fibroblasts, stimulated by inflammatory mediators such as cytokines and growth factors, enhance the production of MMPs (Domeij *et al.*, 2002). As such, gingival fibroblasts are implicated in gingival tissue ECM remodelling (Sorsa *et al.*, 2006). However, gingival fibroblasts also produce TIMPs which function to regulate MMP activity (Zhou and Windsor, 2006). Leptin regulates MMP and TIMP production (Schram *et al.*, 2010), but no studies have yet investigated whether leptin has a similar effect in gingival fibroblasts. In the results presented in this chapter the basal gene expression profile of a number of MMPs and TIMPs in hGFs was described.

Furthermore, this study was the first to show that leptin stimulated hGFs to enhance the production of several MMPs, but had no similar regulatory effect on TIMP expression. These results suggest that leptin promotes an ECM remodelling in the gingiva by increasing the ratio of MMPs to TIMPs expressed by gingival fibroblasts.

In agreement with the existing literature, gingival fibroblasts from all donors tested constitutively expressed MMP-1 (Yamada *et al.*, 2000; Domeij *et al.*, 2002), MMP-2 (Zhou *et al.*, 2007; Zhang *et al.*, 2011), MMP-10 (Mah *et al.*, 2014), MMP-14 (Zhou and Windsor, 2006; Zhou *et al.*, 2007; Zhang *et al.*, 2011), TIMP-1 (Yamada *et al.*, 2000; Zhou and Windsor, 2006; Cury *et al.*, 2007), TIMP-2 (Zhou and Windsor, 2006; Cury *et al.*, 2007; Zhang *et al.*, 2011) and TIMP-3 (Arris *et al.*, 2003). Furthermore, the lack of detectable basal gene expression of MMP-9 (Zhou and Windsor, 2006; Kim *et al.*, 2009) and MMP-13 (Leivonen *et al.*, 2002) in gingival fibroblasts observed in this study has also been described previously. No MMP-7 gene expression was detected basally in hGFs which is in agreement with Zhou and Windsor (2006), and similar to Mah *et al.* (2014) who could only detect very low basal expression levels of MMP-7 mRNA in hGFs. Only one other study has reported assessing MMP-8 and MMP-12 gene expression in unstimulated hGFs (from an undisclosed number of donors), and the authors found that neither MMPs were expressed in contrast to the results of the current study (Zhou and Windsor, 2006). It is likely that this discrepancy is due to different RT-PCR methodologies as Zhou and Windsor (2006) performed 30 cycles of semi-

quantitative RT-PCR, whereas in this study 40 cycles of real-time RT-PCR were performed. Overall, the basal profile of MMPs expressed by hGFs in this study tends to agree with the existing literature, and supports the hypothesis that ECM remodelling is a key role for fibroblasts in the gingiva. Further work to characterise the basal protein levels and activities of gingival fibroblast-derived MMPs and TIMPs may help to identify the functional role of fibroblast-derived MMPs in homeostatic ECM remodelling in the gingiva.

This is the first study to report leptin-stimulated MMP and TIMP production in any human fibroblasts. Leptin dose-dependently stimulated the expression of two collagenases, namely MMP-1 and MMP-8, by hGFs. MMPs are the only enzymes which degrade collagen (Burrage *et al.*, 2006), and therefore this finding suggests that leptin could promote gingival fibroblast-mediated collagen degradation via the action of collagenases.

MMP-1 expression in other mesenchymal cells is regulated by leptin, although both upregulation (Hui *et al.*, 2012), and downregulation (Cao *et al.*, 2007) have been described. This discrepancy could be due to the different cell types studied previously (chondrocytes and HSCs) in comparison to hGFs in the current study, but could also be a dose-dependent effect of leptin. Cao *et al.* (2007) used lower concentrations of leptin (25 – 100 ng/ml) than in this study (0.1 – 25 µg/ml) and in the study by Hui *et al.* (2012). However, a 100 ng/ml leptin concentration was tested in the current study and did not alter MMP-1 gene expression in hGFs, in contrast to the decrease in MMP-1 expression at this concentration detected by Cao *et al.* (2007). The JAK/STAT and MAPK signalling pathways have a well-established positive regulatory effect on MMP expression (Vincenti and Brinckerhoff, 2002), however Cao *et al.* (2007) presented evidence that leptin suppressed MMP-1 expression via these same pathways and provided no explanation for this inconsistency.

MMP-8 is the main target of SDD, and SDD is approved as an adjunct therapy for periodontitis as it reduces the destruction of the periodontal tissues (Preshaw, 2008). It is suggested that SDD is an effective adjunct treatment for periodontitis because it is more effective at inhibiting ‘neutrophil-derived’ MMP-8 than ‘fibroblast-derived’ MMP-1 (Preshaw, 2008). This has resulted in the hypothesis that neutrophils are the mediators of periodontal tissue destruction in periodontitis, while fibroblast-derived MMPs are required for beneficial ECM remodelling. However, neutrophils are not the

only source of MMP-8; a tissue cell-derived MMP-8 (which is processed slightly differently to its neutrophil-derived counterpart) has been described (Kiili *et al.*, 2002). Additionally, MMP-8 protein is produced by gingival fibroblasts derived from individuals with chronic periodontitis (Cox *et al.*, 2006). Therefore, the implications of leptin increasing MMP-8 expression in hGFs are important, and suggest that gingival fibroblasts could be a source of MMP-8 in conditions of hyperleptinaemia, and that via gingival fibroblast derived MMP-8, leptin may promote deleterious ECM remodelling in the gingiva. Further study of MMP-8 protein secretion by leptin-stimulated hGFs should be carried out by Western blotting to determine which molecular weight forms are secreted; this should identify whether leptin drives MMP-8 secretion by hGFs, and whether any secreted MMP-8 is active.

In a previous study, leptin significantly increased the expression of the third collagenase MMP-13 in primary chondrocytes (Hui *et al.*, 2012), while leptin did not induce MMP-13 expression in hGFs in this study. This discrepancy could be due to the different cell types studied and the different anatomical locations that they were isolated from. In support of this, the cartilage specific transcription factor RUNX2 is required to promote MMP-13 expression in chondrocytes (Burrage *et al.*, 2006). This suggests that the responses that leptin generates may vary depending on cell-type and anatomical location due to inherent differences between cells/tissues.

In this study, leptin dose-dependently increased the secretion of the stromelysin MMP-3 by hGFs, which is in agreement with a previous study investigating leptin-stimulated MMP-3 production in cartilage (Koskinen *et al.*, 2011). Similarly, leptin appeared to enhance the expression of another stromelysin, MMP-10, in hGFs; no other studies have reported an ability of leptin to regulate MMP-10. However, MMP-10 expression was only assessed in one donor by semi-quantitative RT-PCR. For increased confidence in this finding, future studies should assess leptin-mediated MMP-10 expression quantitatively at the RNA and protein level, and in more donors. The stromelysins have a broad ECM substrate specificity including non fibrillar collagens, fibronectin, elastin, aggrecan and laminin, but also cleave (and therefore activate) other MMPs including the collagenases (Burrage *et al.*, 2006). Consequently, increases in, and accumulation of, fibroblast-derived collagenases and stromelysins in the gingiva at the same time may enhance widespread ECM remodelling including fibrillar collagen degradation, via the activation of collagenases by stromelysins.

The gelatinase MMP-2 is the only MMP which has no TATA box and no Ets transcription factor binding sites within its promoter (Vincenti and Brinckerhoff, 2002). Therefore, unlike the other MMPs, MMP-2 is not highly regulated at the level of gene expression. In agreement with this, leptin has no ability to regulate MMP-2 expression in a glioma cell line (Yeh *et al.*, 2009), and had no ability to regulate MMP-2 expression in hGFs in this study, although MMP-2 mRNA was detected constitutively. In contrast, leptin dose-dependently increased MMP-2 expression as assessed by semi-quantitative RT-PCR in HUVECs (Park *et al.*, 2001). However, the time point at which gene expression was assessed was not reported in this study, and may explain this inconsistency. Several studies have reported that leptin increases MMP-2 activity (McMurtry *et al.*, 2009; Schram *et al.*, 2010; Schram *et al.*, 2011). As well as targeting ECM components, membrane-type MMP-14 (in complex with TIMP-2) is thought to promote pericellular MMP-2 activity (Nagase *et al.*, 2006; Henderson *et al.*, 2007). Leptin increases MMP-14 protein production and surface expression in primary rat cardiac fibroblasts (Schram *et al.*, 2011), and similarly, leptin increased MMP-14 expression in hGFs in this study. Presuming the MMP-2 and MMP-14 gene expression levels identified in this study translate to protein levels, it is possible that leptin may enhance MMP-2 activity by increasing MMP-14 expression in hGFs. Therefore, pericellular ECM remodelling by hGFs could be increased during hyperleptinaemia. However, as leptin appeared to reduce TIMP-2 expression in hGFs in this study, further work must be done to determine if leptin affects the activity of MMP-2 via the MMP-14:TIMP-2 axis in hGFs. One approach would be to use gelatin zymography to assess the levels of active MMP secreted by hGFs. However, TIMP-2 expression was only assessed in one donor and by using semi-quantitative RT-PCR. For increased confidence in this result, leptin-mediated TIMP-2 expression should also be assessed in future studies quantitatively at the RNA and protein level, and in more donors.

Two other studies have investigated the effect of leptin on expression of the gelatinase MMP-9, both using semi-quantitative RT-PCR (Park *et al.*, 2001; Yeh *et al.*, 2009). Yeh *et al.* (2009) found that leptin had no effect on MMP-9 expression in a glioma cell line, while Park *et al.* (2001) found that leptin dose-dependently increased MMP-9 expression in HUVECs, although the time point at which gene expression was assessed was not reported in this study. However, MMP-9 was constitutively expressed in both these cell types, in contrast to the findings in gingival fibroblasts in this study. This suggests that gingival fibroblasts lack cell-specific transcription factors like RUNX2

that are required for MMP-9 expression (or at least expression at a detectable level), similar to that described for MMP-13 earlier (Pratap *et al.*, 2005).

MMP inhibitors, such as TIMPs, have a well established functional ability to reduce ECM degradation (Ellis *et al.*, 1994). Leptin had no ability to increase the expression of TIMP-1, TIMP-2 and TIMP-3 in hGFs. While no other studies have reported an ability of leptin to regulate TIMP-2 and TIMP-3, the finding regarding TIMP-1 in this study is inconsistent with previous studies (Park *et al.*, 2001; Schram *et al.*, 2010), although neither of these previous studies assessed TIMP-1 expression in human fibroblasts. For example, Park *et al.* (2001) found that leptin increased TIMP-1 expression, as assessed by semi-quantitative RT-PCR, in HUVECs. In contrast, Schram *et al.* (2010) found that leptin reduced TIMP-1 expression in a murine cardiac cell line. These inconsistencies suggest that TIMP-1 expression is regulated in a cell type-specific manner. Together, the results in this study suggest that leptin does not increase TIMP-mediated MMP inhibition by gingival fibroblasts. However, TIMPs also appear to have functions outside of regulating MMP activity. For example, TIMP-3 inhibits angiogenesis by blocking VEGF binding to its receptor (Qi *et al.*, 2003). The lack of increased TIMP expression by leptin-stimulated hGFs suggests that leptin may not affect other functions of fibroblast-derived TIMPs in the gingiva, at least in respect to functions affected by TIMP-1-3 expression levels.

The dose-dependent effect of leptin on MMP-1 and MMP-3 production was consistent between donors in this study, while the absolute concentrations of MMP-1 and MMP-3 produced by leptin-stimulated hGFs were donor-dependent. Similar differences in responses between hGF donors have been described previously (Faria Morandini *et al.*, 2012). The implications of this finding are important and suggest that the concentrations of fibroblast derived MMP-1 and MMP-3 in the gingiva, and therefore the potential for gingival ECM degradation, may be inherently different between individuals. The analysis of leptin-mediated MMP-1 and MMP-3 production in a larger number of hGF donors could identify the extent of donor-dependent variation in leptin responses. If this is confirmed then future studies could aim to identify if these donor-dependent differences in leptin responses were due to differences in the characteristics of individual donors (e.g. gender, age, BMI) or perhaps the result of genetic polymorphism.

Overall, the results presented in this chapter demonstrate that leptin-stimulated gingival fibroblasts regulate a specific group of MMPs (MMP-1, MMP-3, MMP-8, MMP-10 and MMP-14). Other MMPs are regulated by leptin in other cell types (Section 1.4.3), indicating that gingival fibroblasts have an innate ability to determine which MMPs are regulated by leptin. Nonetheless, leptin regulated (or failed to regulate) a particular selection of MMPs in hGFs which was different to the MMPs that other stimuli such as cytokines and bacterial supernatants regulate in gingival fibroblasts (Section 1.11.1). The increased hGF proliferation stimulated by leptin in this study was unlikely to account for the changes in MMP and TIMP expression observed because the extent of expression change differed between individual MMPs and TIMPs. Together, this indicates that leptin regulates MMP and TIMP expression in gingival fibroblasts in a specific manner. Several mechanisms may determine how leptin regulates the MMPs in gingival fibroblasts that can be expressed such as increasing MMP gene transcription, mRNA stability or secretion rate.

All of the promoters of the MMPs upregulated by leptin contain binding sites for the transcription factor Ets. Ets is activated downstream of the MAPK signalling pathway (Yordy and Muise-Helmericks, 2000), and this signalling pathway is activated by leptin (Section 1.2.2). Therefore, leptin could regulate MMP expression in hGFs via Ets. However, leptin activates a number of intracellular signalling pathways that are implicated in regulating MMP production (Section 1.2.2), and MMP gene expression is widely thought to be regulated by the coordinate action of multiple cis-acting factors (Fanjul-Fernandez *et al.*, 2010). Further studies investigating the intracellular signalling pathways and the transcription factors by which leptin regulates MMP synthesis in hGFs are warranted; subsequently an investigation into which signalling pathways are involved was performed in this study (Chapter 5).

The results presented in this chapter also suggest that leptin-stimulated gingival fibroblasts promote MMP activity by increasing the MMP:TIMP ratio. However, the results of the MMP activity assay described in this chapter suggest that either MMP activity in hGF supernatants was below the sensitivity of the assay, or that leptin only increases the production, and not activity, of MMPs by hGFs. If the latter is true, these results could still be relevant to ECM degradation in the gingiva during hyperleptinaemia because proteases derived from non-gingival fibroblasts and microbial proteases are implicated in activating MMPs (Beklen *et al.*, 2006; Cox *et al.*, 2006). Therefore, gingival fibroblasts could be a source of pro-MMPs, but these pro-MMPs

may only be activated in the presence of existing protease activity in the gingiva, which is not present in *in vitro* single cell type studies.

The results presented in this chapter suggest that leptin promotes gingival ECM remodelling. ECMs are not fixed structures; for example, altered ECM remodelling is a feature of fibrosis and tissue destruction (Lu *et al.*, 2011), however ECM remodelling (and MMP activity) also serves physiological purposes (e.g. in development and wound healing) (Page-McCaw *et al.*, 2007). Therefore, while leptin may promote gingival ECM remodelling, this may not necessarily be involved in the deleterious tissue destruction of periodontitis. Indeed, while elevated levels of MMPs are found in numerous pathologies related to ECM degradation, evidence is lacking to show that MMPs play a causal role (Fanjul-Fernandez *et al.*, 2010). For example, many clinical studies have identified increased MMP levels in individuals with chronic periodontitis compared to health (Section 1.9.2). It would be more informative to measure MMP levels across a range of clinical categories (e.g. gingivitis and mild to severe periodontitis). This kind of approach has been performed in our laboratory and it was found that total salivary MMP-8 (i.e. active and inactive) is highly predictive for both gingivitis and periodontitis (Preshaw *et al.*, 2013). Therefore, if MMP-8 is involved in ECM destruction in periodontitis, the MMP-8 measured in gingivitis must be predominantly inactive. Alternatively, MMP-8 may not be as important in the deleterious ECM destruction observed in periodontitis as first thought.

Numerous physiological and biochemical alterations have been described as part of the starvation response (Friedman and Halaas, 1998). Perhaps in periods of starvation (and consequently hypoleptinaemia) the optimal level of gingival ECM remodelling would cost too much energy. Leptin could serve to inform gingival fibroblasts of the metabolic status of an organism, thereby ensuring that the functions of gingival fibroblasts (e.g. ECM remodelling) use an available amount of energy. A similar link between leptin, energy status and peripheral cell function has been described previously regarding the immunocompetence of T cells (Saucillo *et al.*, 2014).

Further lines of work could be pursued in relation to the results presented in this chapter. It would be interesting to identify the full profile of MMPs, TIMPs, other proteases/inhibitors and ECM components produced by hGFs and how the production of these molecules are affected by leptin in an effort to gain an holistic understanding of the ECM remodelling potential of leptin-stimulated gingival fibroblasts. It would be

useful to use alternative methods to assess whether the MMPs produced by leptin-stimulated hGFs are active; gelatin zymography could be used to assess MMP-2 activity, while an immunoblotting approach could be used to assess whether the inactive or active forms of other MMPs are produced. As the gingival microenvironment is complex, it is highly improbable that leptin would be the only stimulus affecting gingival fibroblasts. Therefore, studies investigating how leptin regulates the ECM-degrading phenotype of gingival fibroblasts in combination with other stimuli relevant to gingivitis and periodontitis are warranted; this is presented in Chapter 4. Further, it would be valuable to determine whether the ability of leptin to regulate the ECM-degrading phenotype of gingival fibroblasts translates to ECM degradation in the gingiva, and whether this is beneficial or deleterious; *in vivo* or 3-dimensional tissue models may be suitable tools for this (see Chapter 7).

In conclusion, the results presented in this chapter provide the first evidence that leptin selectively regulates MMP and TIMP expression in hGFs. These results imply that leptin promotes an ECM-degrading gingival fibroblast phenotype by increasing the MMP:TIMP ratio, and by increasing the expression of MMPs that can activate other MMP family members. These results add valuable information regarding the potential for gingival fibroblast-mediated ECM remodelling during hyperleptinaemia.

Table 3.1: MMP and TIMP gene expression in hGFs under basal conditions and after stimulation with leptin.

cDNA was prepared from unstimulated hGFs or hGFs after stimulation with leptin (0.1, 0.5, 1, 10, 25 µg/ml) for 24 h and gene expression was determined by RT-PCR. For each MMP/TIMP the number of donors assessed is indicated. + indicates basal gene expression in all donors, +/- indicates basal gene expression in some donors, - indicates no basal gene expression in all donors assessed. The value for MMP-8 mRNA expression (fold unstimulated control) is presented as mean±SD (n=6 from three donors stimulated in independent experiments), and was tested for statistical significance using the t test for independent samples.

Group	MMP	Basally expressed	Regulated by leptin (10µg/ml)	Number of donors tested
Collagenase	MMP-1	+	Yes - upregulated	7
	MMP-8	+	Yes - upregulated 2.6±1.0-fold control	3
	MMP-13	-	No	4
Gelatinase	MMP-2	+	No	3
	MMP-9	-	No	2
Stromelysin	MMP-3	+/-	No	4
	MMP-10	+	Yes - upregulated	1
Matrilysin	MMP-7	-	No	2
Membrane-type MMP	MMP-14	+	Yes - upregulated	3
Other MMPs	MMP-12	+	No	3
TIMPs	TIMP-1	+	No	4
	TIMP-2	+	No - downregulated	1
	TIMP-3	+	No	3

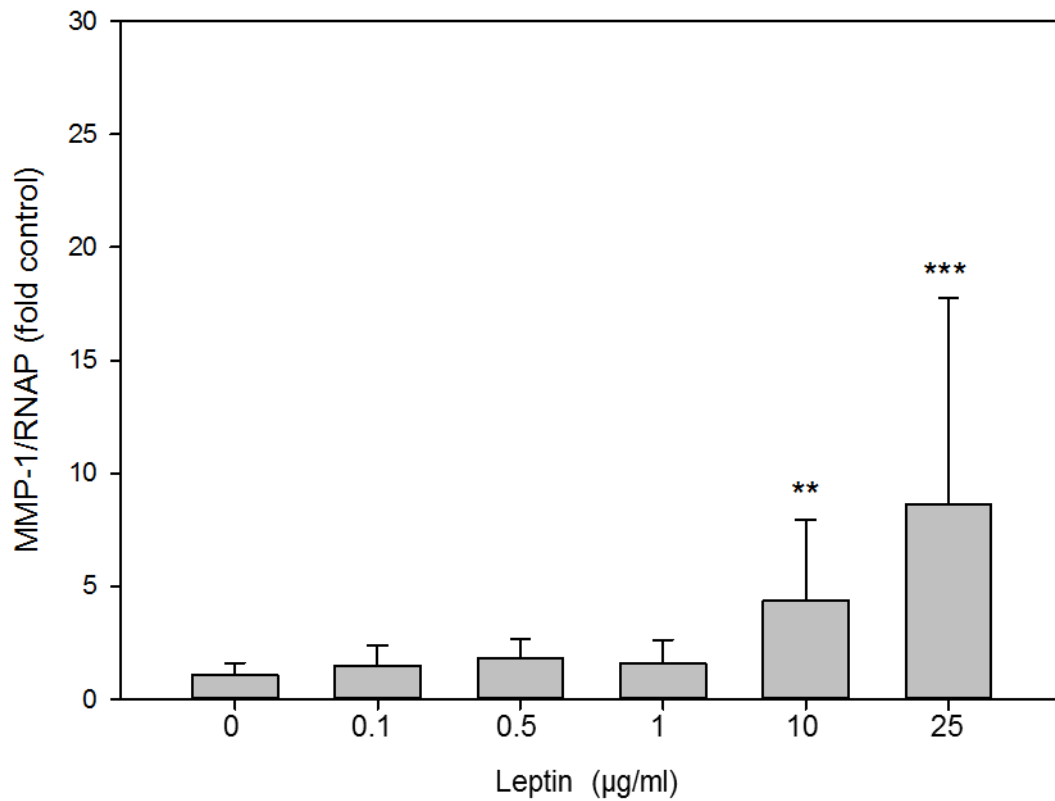

Figure 3.1: MMP-1 mRNA expression in hGFs after leptin stimulation.

hGFs were stimulated with leptin (0 – 25 µg/ml) for 24 h. Cells were lysed and cDNA was prepared by reverse transcription. Real-time RT-PCR was used to assess MMP-1 and RNAP gene expression. Relative MMP-1 gene expression was determined using the $2^{-\Delta\Delta C_t}$ method by using RNAP as the reference gene. Data are shown as mean+SD (n=12) from three donors stimulated in independent experiments. Statistics: T tests for independent samples (Bonferroni-corrected) **=p<0.01, ***=p<0.001 compared to unstimulated control.

Table 3.2: MMP-1 protein secretion by hGFs after leptin stimulation.

hGFs were stimulated with leptin (0 – 25 µg/ml) for 24 h. Supernatants were collected and MMP-1 concentrations were assessed by ELISA. Table displays the mean±SD (n=4) MMP-1 concentration (ng/ml) for each donor tested at each concentration of leptin. Statistics: T tests for independent samples (Bonferroni-corrected) ***=p<0.001 compared to 0, 0.1, 0.5 and 1 µg/ml leptin, ###=p<0.001 compared to 10 µg/ml leptin. ND – not detected.

Leptin (µg/ml)	0	0.1	0.5	1	10	25
Donor 1	ND	ND	ND	ND	0.32 ± 0.08	1.07 ± 0.14 ^{###}
Donor 2	0.34 ± 0.05	0.34 ± 0.10	0.36 ± 0.03	0.42 ± 0.02	2.74 ± 0.29 ^{***}	7.64 ± 1.07 ^{***###}
Donor 3	0.72 ± 0.14	0.85 ± 0.26	0.66 ± 0.02	0.79 ± 0.10	2.48 ± 0.52 ^{***}	3.06 ± 0.67 ^{***}

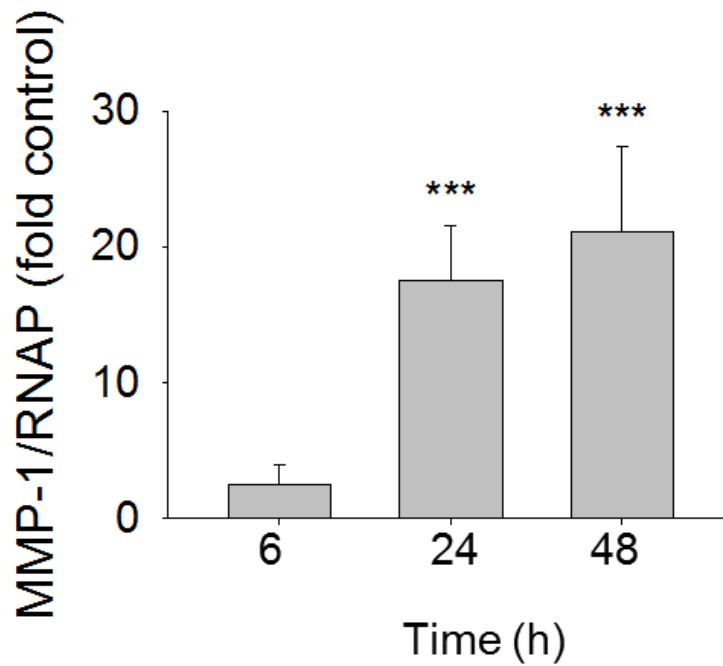

Figure 3.2: MMP-1 mRNA expression in hGFs after different durations of leptin stimulation.

hGFs were stimulated with leptin (10 $\mu\text{g/ml}$) for 6 - 48 h. Cells were lysed and cDNA was prepared by reverse transcription. Real-time RT-PCR was used to assess MMP-1 and RNAP gene expression. Relative MMP-1 mRNA expression was determined using the $2^{-\text{ddCt}}$ method by using RNAP as the reference gene and the 6 h unstimulated control as the reference treatment condition. Data are shown as mean+SD (n=4) from one donor as fold MMP-1 gene expression compared to the 6 h unstimulated control (not shown). Statistics: T tests for independent samples (Bonferroni-corrected) ***= $p < 0.001$ compared to 6 h time point.

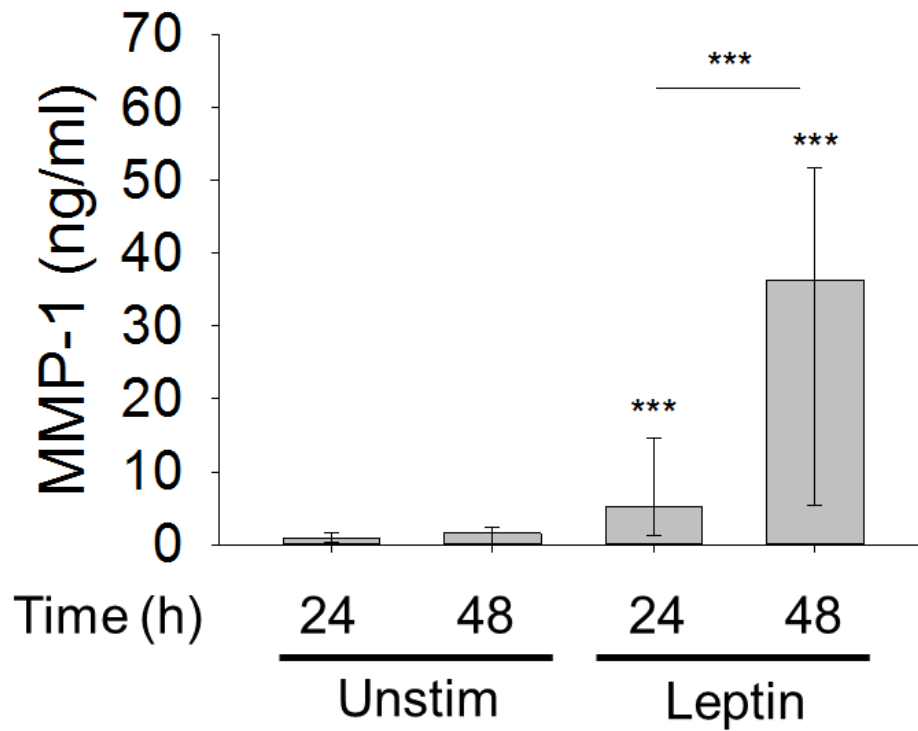

Figure 3.3: MMP-1 protein secretion by hGFs after different durations of leptin stimulation.

hGFs were stimulated with leptin (10 $\mu\text{g/ml}$) for 24 or 48 h. Supernatants were collected and MMP-1 concentrations were assessed by ELISA. Data (median +IQR, n=12) are presented as fold unstimulated control at 24 h from three donors stimulated in independent experiments. Statistics: Mann-Whitney U test for independent samples (Bonferroni-corrected) ***= $p < 0.001$ compared to unstimulated control at the same time point unless indicated otherwise.

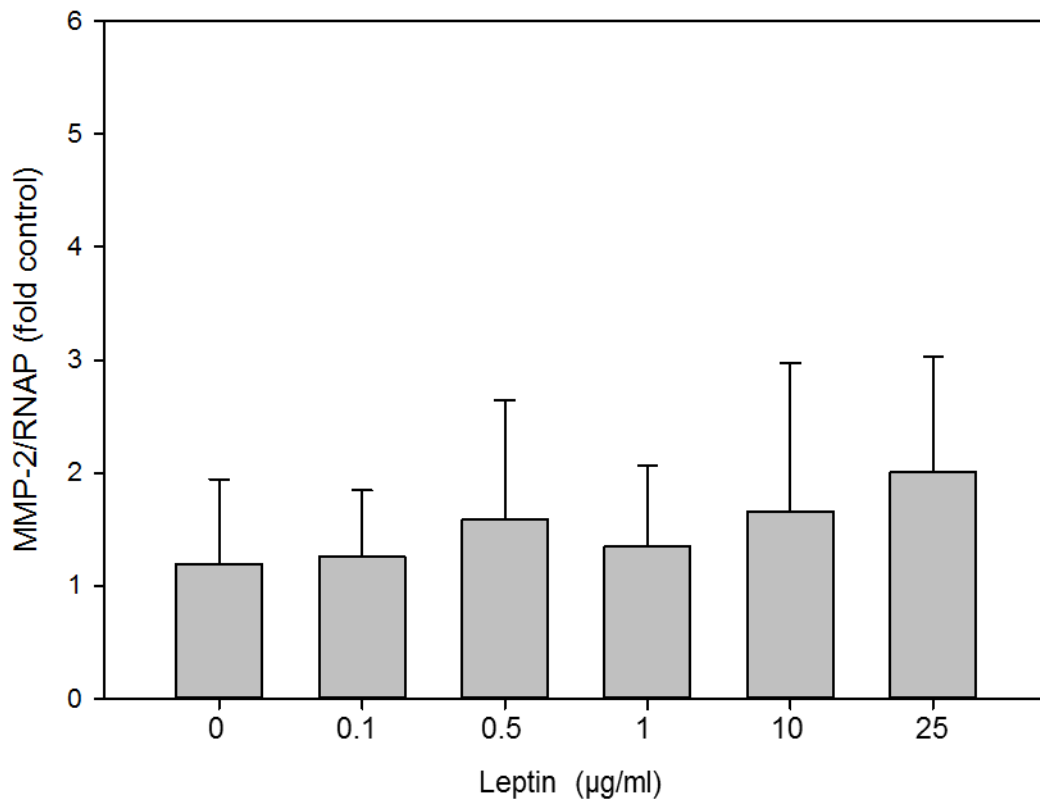

Figure 3.4: MMP-2 mRNA expression in hGFs after leptin stimulation.

hGFs were stimulated with leptin (0 – 25 µg/ml) for 24 h. Cells were lysed and cDNA was prepared by reverse transcription. Real-time RT-PCR was used to assess MMP-2 and RNAP gene expression. Relative MMP-2 mRNA expression was determined using the $2^{-\Delta\Delta C_t}$ method by using RNAP as the reference gene. Data are shown as mean+SD (n=12) from three donors stimulated in independent experiments. Statistics: T tests for independent samples (Bonferroni-corrected).

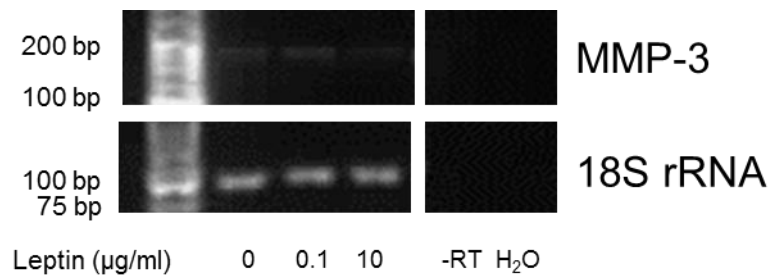

Figure 3.5: MMP-3 mRNA expression in hGFs after leptin stimulation.

hGFs were stimulated with leptin (0 – 10 µg/ml) for 24 h. Cells were lysed and cDNA was prepared by reverse transcription. Semi-quantitative RT-PCR was used to assess MMP-3 and 18S rRNA gene expression. The expected product size for MMP-3 was 150 bp, and for 18S rRNA was 85 bp. For clarity several other lanes from these gels have been omitted; however the entire gel is displayed in Figure 4.3. The MMP-3 mRNA expression levels detected in this donor are representative of those observed in two other donors stimulated with leptin in independent experiments.

Table 3.3: MMP-3 protein secretion by hGFs stimulated with leptin.

hGFs were stimulated with 10 µg/ml leptin (unless otherwise indicated for [A] 24 h or [B] 24-48 h. Supernatants were collected and analysed for MMP-3 by ELISA. Tables displays the mean±SD (n=4) MMP-3 concentration (pg/ml) for each donor tested. Statistics: T tests for independent samples (Bonferroni-corrected) [A] ***=p<0.001 compared to 0, 0.1, 0.5 and 1 µg/ml leptin. [B] **=p<0.01, ***=p<0.001 compared unstimulated control at the same time point; #=p<0.05, ###=p<0.001 compared to 24 h time point for the same treatment conditions. ND – not detected.

[A]

Leptin (µg/ml)	0	0.1	0.5	1	10	25
Donor 1	ND	ND	ND	ND	ND	123 ± 13
Donor 2	ND	ND	ND	ND	ND	302 ± 24
Donor 3	236 ± 66	235 ± 15	222 ± 23	226 ± 49	667 ± 56***	838 ± 31***

[B]

	24 h unstimulated	24 h leptin	48 h unstimulated	48 h leptin
Donor 2	95.1 ± 27	437 ± 62***	152 ± 34 [#]	825 ± 12***###
Donor 3	432 ± 72	1760 ± 510**	930 ± 440	3350 ± 180***###
Donor 4	ND	ND	ND	ND

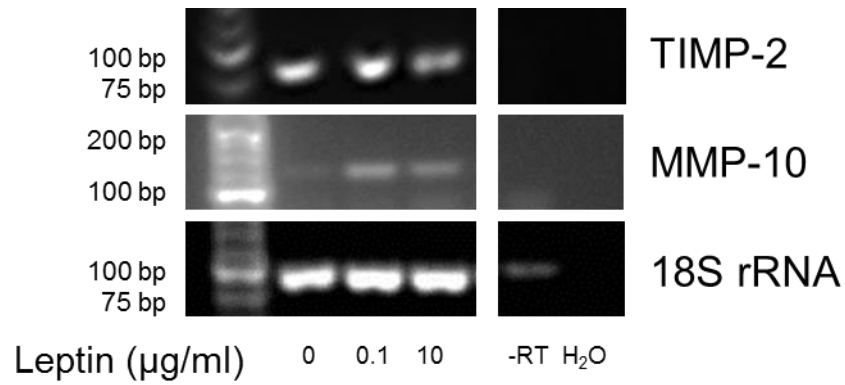

Figure 3.6: TIMP-2 and MMP-10 gene expression in hGFs after leptin stimulation.

hGFs from one donor were stimulated with leptin (0 – 10 $\mu\text{g/ml}$) for 24 h. Cells were lysed and cDNA was prepared by reverse transcription. Semi-quantitative RT-PCR was used to assess TIMP-2, MMP-10 and 18S rRNA gene expression. The expected product size for TIMP-2 was 77 bp, MMP-10 was 113 bp and for 18S rRNA was 85 bp. For clarity several other lanes from these gels have been omitted; however the entire gel is displayed in Figure 4.7. The faint band for 18S observed in the –RT control may be due to the nature of the cell lysis and cDNA generation protocol. No similar band was detected in the H₂O control.

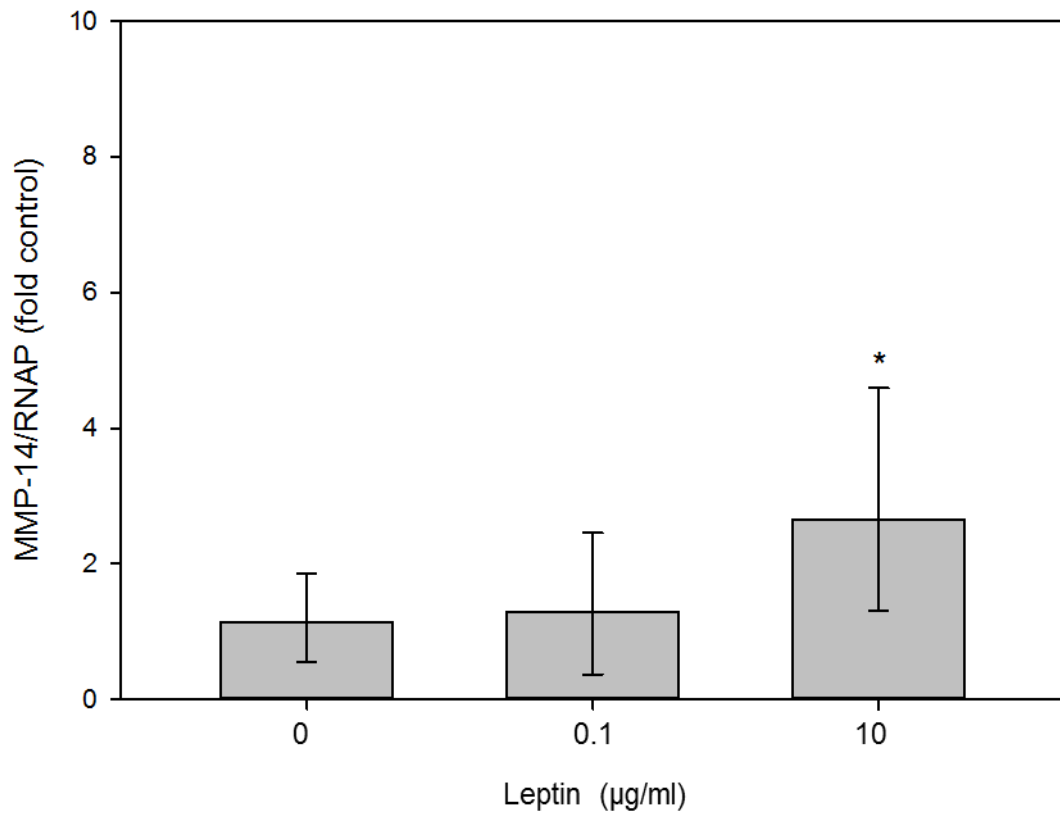

Figure 3.7: MMP-14 gene expression in hGFs after leptin stimulation.

hGFs were stimulated with leptin (0 – 10 µg/ml) for 24 h. Cells were lysed and cDNA was prepared by reverse transcription. Real-time RT-PCR was used to assess MMP-14 and RNAP gene expression. Relative MMP-14 mRNA expression was determined using the $2^{-\text{ddCt}}$ method by using RNAP as the reference gene. Data are shown as median+IQR (n=12-26) from 3 donors stimulated in independent experiments. Statistics: Mann-Whitney U test for independent samples (Bonferroni-corrected) $*=p<0.05$ compared to unstimulated control.

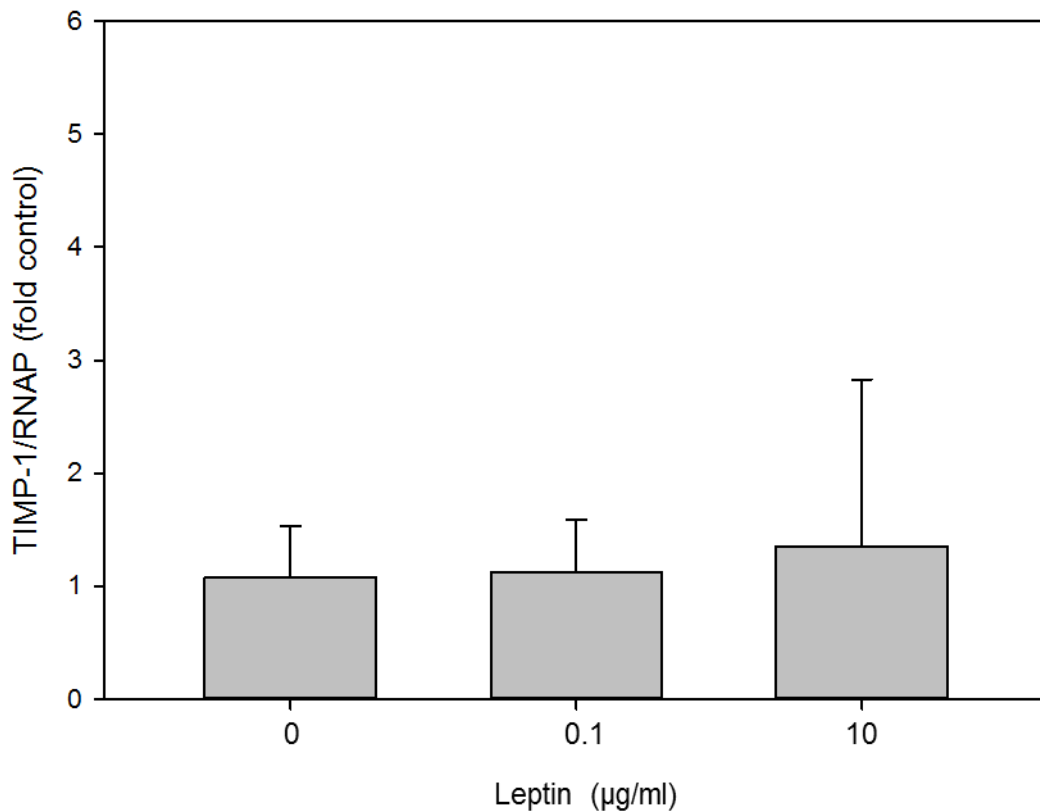

Figure 3.8: TIMP-1 gene expression in hGFs after leptin stimulation.

hGFs were stimulated with leptin (0 – 10 µg/ml) for 24 h. Cells were lysed and cDNA was prepared by reverse transcription. Real-time RT-PCR was used to assess TIMP-1 and RNAP gene expression. Relative TIMP-1 gene expression was determined using the $2^{-\Delta\Delta C_t}$ method by using RNAP as the reference gene. Data are shown as mean+SD (n=12-26) from three donors stimulated in independent experiments. Statistics: T tests for independent samples (Bonferroni-corrected).

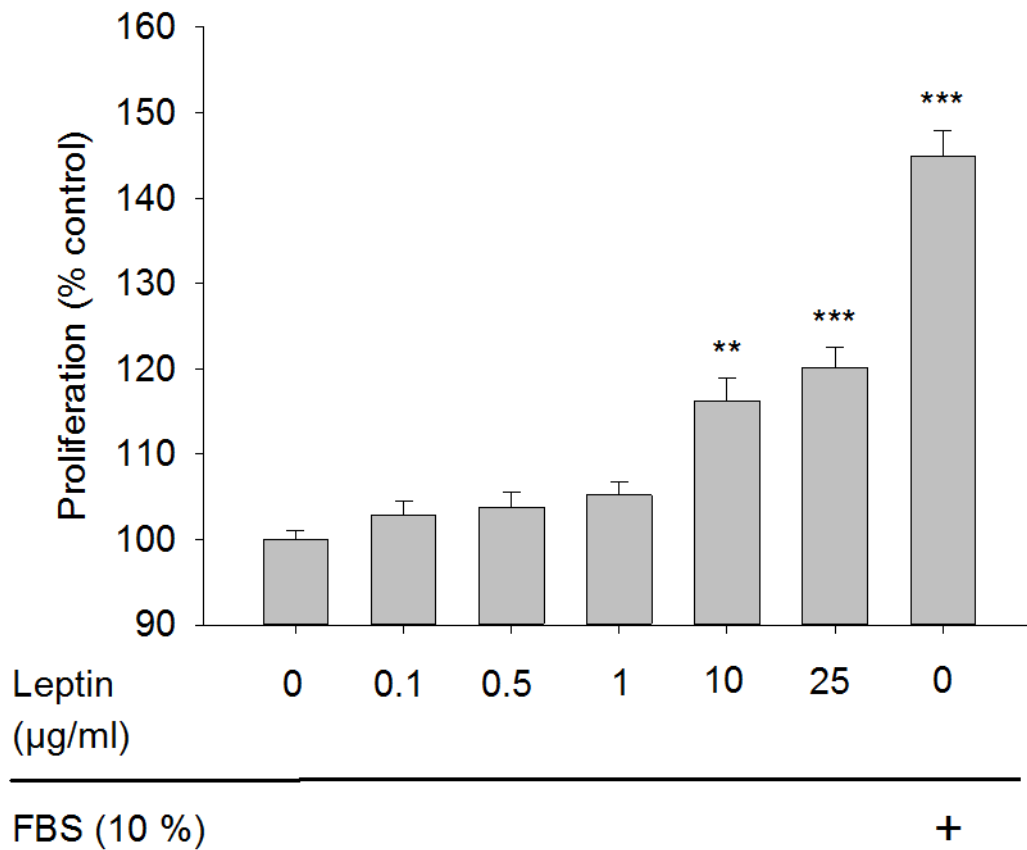

Figure 3.9: hGF proliferation after stimulation with leptin

hGFs were stimulated with leptin for 24 h. Proliferation was assessed using a tetrazolium compound based assay. Data (mean+SD, n=12) are shown relative to the unstimulated control (% control) from three donors stimulated in independent experiments. Statistics: T tests for independent samples (Bonferroni-corrected): **= $p < 0.01$, ***= $p < 0.001$ compared to unstimulated control.

4 Chapter 4. Synergistic regulation of MMP and TIMP production in gingival fibroblasts by leptin and pro-inflammatory mediators

4.1 Introduction

Leptin is one of a number of inflammatory mediators that regulate MMP and TIMP production in mesenchymal cells (Vincenti and Brinckerhoff, 2002). The pro-inflammatory cytokine IL-1 β enhances the expression of the collagenases MMP-1, MMP-8 and MMP-13 in gingival fibroblasts (Abe *et al.*, 2001). IL-1 β also stimulates the secretion of MMP-1 and the stromelysin MMP-3 by gingival fibroblasts (Domeij *et al.*, 2002; Kida *et al.*, 2005). Increased levels of active or partially active MMP-1 and MMP-13 are observed in gingival fibroblasts isolated from individuals with chronic periodontitis after stimulation with IL- β (Cox *et al.*, 2006); whether or not IL-1 β elicits the same response in fibroblasts isolated from periodontally healthy individuals was not tested. IL-1 β also significantly increases the production of the gelatinase MMP-2 in PDL cells (Xiang *et al.*, 2009). The pro-inflammatory cytokine TNF- α stimulates the secretion of MMP-1, MMP-3, MMP-8 and the gelatinase MMP-9 by gingival fibroblasts (Domeij *et al.*, 2002; Beklen *et al.*, 2006). The adipokine adiponectin, lipoxin A4, and the cytokines IL-17 and TGF- β also increase the production of MMPs and TIMPs in fibroblasts (Sodin-Semrl *et al.*, 2000; Stuelten *et al.*, 2005; Cortez *et al.*, 2007; Kim *et al.*, 2010b). Taken together, these studies support an ability for numerous, and distinct, endogenous inflammatory mediators to regulate the ECM-degrading phenotype of fibroblasts and cells found within the periodontium by controlling MMP and TIMP production.

Supernatants from *P. gingivalis* cultures enhance the proportions of active MMP-1, MMP-2 and MMP-3 in cultures of gingival fibroblasts; these supernatants also increase the collagen degrading ability of gingival fibroblasts (Zhou *et al.*, 2007; Zhang *et al.*, 2010). This suggests that microbial molecules can increase MMP activity. Additionally, LPS derived from numerous bacteria (including periodontal pathogens) regulates MMP and TIMP production by gingival fibroblasts; however, MMPs and TIMPs are differentially regulated by LPS from different bacteria (Bodet *et al.*, 2007; Herath *et al.*, 2013). The regulation of gingival fibroblast-derived MMPs and TIMPs by bacteria is potentially relevant to periodontitis as microbial products are implicated in disease pathogenesis (Darveau, 2010). It is possible that microbial stimuli regulate MMP and

TIMP production due to their ability to stimulate IL-1 β and TNF- α (Wang and Ohura, 2002; Tardif *et al.*, 2004).

IL-1 α and OSM synergise to increase MMP-1 secretion by gingival and synovial fibroblasts (Cawston *et al.*, 1998; Sukkar *et al.*, 2007). Only one other study has investigated the interaction between pro-inflammatory stimuli in regulating the ECM-degrading phenotype of gingival fibroblasts (Ruwanpura *et al.*, 2004). In this study, PGE₂ regulated the ability of IL-1 β to promote MMP-3 secretion by gingival fibroblasts. However, the regulatory effect of PGE₂ was positive in fibroblasts derived from individuals with periodontitis, and negative in fibroblasts derived from healthy periodontium. These studies suggest that the extent of gingival fibroblast-mediated ECM degradation depends, in part, on the combination of inflammatory mediators present.

Leptin synergises with LPS derived from periodontal pathogens (*P. gingivalis* and *P. intermedia*) to increase the production of TNF- α by THP-1 monocytes or macrophages (Kim, 2010; Jaedicke *et al.*, 2013). However, leptin and LPS have no synergistic ability to regulate IL-6 and CXCL8 production by PDL fibroblasts (Park *et al.*, 2013). However, Park *et al.* (2013) did not report the type of LPS used, the number of donors tested and experimental repeats performed. As such, the ability of leptin to synergise with inflammatory mediators in models relevant to periodontitis is unclear. However, leptin synergises with IL-1 α to increase MMP-1 and MMP-13 production in chondrocytes, and to increase bovine cartilage degradation (Hui *et al.*, 2012). Similarly, leptin and IL-1 synergistically increase the production of MMP-1, MMP-3 and MMP-13 by human cartilage acquired from individuals with osteoarthritis (Koskinen *et al.*, 2011). These studies suggest that leptin may enhance ECM degradation under inflammatory conditions by promoting the production of MMPs. No studies have reported whether leptin interacts with pro-inflammatory mediators to regulate MMP and TIMP production in cells of the periodontium.

Periodontitis is characterised by destruction of the periodontal tissues, and I have already demonstrated that leptin may enhance an ECM-degrading gingival fibroblast phenotype (Chapter 3); however, other inflammatory mediators have a similar effect. Leptin can synergise with inflammatory mediators to enhance the production of MMPs in chondrocytes and cartilage explants. No-one has yet assessed whether the production of MMPs by gingival fibroblasts is similarly synergistically regulated, and therefore

whether or not leptin might have a role in gingival fibroblast-regulated ECM homeostasis during inflammation. Therefore, the aim of the experiments presented in this chapter was to determine whether leptin synergises with pro-inflammatory stimuli to regulate the production of MMPs and TIMPs in hGFs.

4.2 MMP and TIMP production by gingival fibroblasts in response to stimulation with leptin and pro-inflammatory cytokines

hGFs were stimulated for 24 h with or without leptin (0.1 and 10 µg/ml) and:

1. IL-1 α (0.05 ng/ml).
2. OSM (5 ng/ml).
3. IL-1 α +OSM (IL-1 α 0.05 ng/ml, OSM 5 ng/ml)

A 24 h stimulation was chosen because increases in MMP production by gingival fibroblasts have been detected at this time point previously (See sections 1.11.1 and 3.3). The pro-inflammatory stimuli were chosen because they synergistically regulate MMP production in chondrocytes and cartilage (Cawston *et al.*, 1998; Koshy *et al.*, 2002; Milner *et al.*, 2006; Hui *et al.*, 2012). hGFs were either lysed and cDNA prepared by reverse transcription or relative levels of cell proliferation were assessed using a tetrazolium compound-based assay. RT-PCR was used to determine the relative MMP and TIMP gene expression levels after leptin stimulation. MMP concentrations in the supernatants were assessed by ELISA. Unstimulated hGFs at each time point were used as a control, while hGFs treated with DMEM+ were used as a positive control for the proliferation assay. A synergistic relationship was inferred if MMP/TIMP expression in hGFs was significantly different after stimulation with multiple stimuli in comparison to the individual stimuli (e.g. leptin+IL-1 significantly different to leptin or IL-1).

Leptin (0.1 µg/ml) did not synergise with IL-1 α , OSM or IL-1 α +OSM to enhance MMP or TIMP synthesis (Table 4.1). Because of these results, and the finding that 0.1 µg/ml leptin had no effect on MMP or TIMP production as observed previously (Section 3.3), the remaining results in this section refer to leptin at a concentration of 10 µg/ml unless otherwise indicated.

hGF proliferation was significantly increased by IL-1 α , OSM and IL-1 α +OSM at 24 h (Figure F.1). Leptin (0.1 and 10 µg/ml) did not synergise with IL-1 α , OSM and IL-1 α +OSM to increase hGF proliferation at 24 h.

A summary of the MMP/TIMP gene expression levels in hGFs after stimulation with 10 µg/ml leptin, IL-1 and OSM as determined by real-time RT-PCR can be found in Table 4.2.

4.2.1 Synergistic regulation of MMP-1 production by gingival fibroblasts after stimulation with leptin, IL-1 and OSM

Leptin and IL-1 α synergised to increase MMP-1 mRNA levels in hGFs at 24 h (Figure 4.1). MMP-1 expression in leptin+IL-1 α -stimulated hGFs was 16-fold higher than leptin and 15-fold higher than IL-1 α -stimulated hGFs (both $p < 0.001$). To determine whether leptin and IL-1 α had a similar effect on MMP-1 secretion, MMP-1 concentrations in leptin and IL-1 α -stimulated hGF supernatants were assessed. Leptin and IL-1 α synergistically increased secreted MMP-1 protein levels in hGFs (Figure 4.2). MMP-1 secretion in leptin+IL-1 α -stimulated hGFs (15.9 ng/ml, $p < 0.001$ compared to the unstimulated control) was 11-fold higher than leptin and 27-fold higher than IL-1 α -stimulated hGFs (both $p < 0.001$) (Figure 4.2).

OSM increased MMP-1 mRNA levels in hGFs at 24 h ($p < 0.001$), whether leptin was present or not (Table 4.2). Similarly, MMP-1 protein in leptin+OSM-stimulated hGF supernatants was significantly higher than in the unstimulated control ($p < 0.001$, Table 4.3); secreted levels of MMP-1 after leptin+OSM stimulation were not significantly different to those detected for hGFs stimulated with leptin alone.

Leptin+IL-1 α +OSM-stimulated hGFs did not significantly increase MMP-1 mRNA or protein levels in hGFs at 24 h above that detected for leptin+IL-1-stimulated hGFs (Table 4.2 and Table 4.3).

4.2.2 Synergistic regulation of MMP-3 production by gingival fibroblasts after stimulation with leptin, IL-1 and OSM

Leptin and IL-1 α synergised to increase MMP-3 mRNA levels in hGFs at 24 h in all three donors tested (Figure 4.3), as assessed by semi-quantitative RT-PCR. However, semi-quantitative differences in MMP-3 mRNA levels in response to leptin and IL-1 between the donors tested were apparent. For example, in hGFs from donors 2 and 3, but not donor 4, IL-1 α stimulation resulted in detectable MMP-3 gene expression (Figure 4.3). Similarly, the extent to which leptin (0.1 µg/ml) synergised with IL-1 α to regulate MMP-3 gene expression in hGFs appeared to be donor-dependent. hGFs isolated from donor 2 had increased MMP-3 mRNA after stimulation with 0.1 µg/ml leptin+IL-1 α ; no similar effect was observed in donors 3 and 4 (Figure 4.3).

In donors 2 and 4 no MMP-3 mRNA was detected in hGFs stimulated with OSM (\pm leptin) at 24 h (Figure 4.3). In donor 3, very faint bands of the correct product size for MMP-3 were detected in hGFs stimulated with OSM (\pm leptin) at 24 h, and were possibly reduced in hGFs treated with 0.1 μ g/ml leptin+OSM compared to OSM and 10 μ g/ml leptin+OSM.

MMP-3 protein was not detected in the supernatants of unstimulated hGFs or hGFs stimulated with OSM (Table 4.3). However, leptin and IL-1 α synergised to increase MMP-3 protein secretion by hGFs (Figure 4.4). MMP-3 secretion in leptin+IL-1 α -stimulated hGFs was 16-fold higher than leptin and 13-fold higher than IL-1 α -stimulated hGFs (both $p < 0.001$) (Figure 4.4). The levels of MMP-3 protein detected were not significantly different between leptin and leptin+OSM-stimulated hGFs (Table 4.3).

Leptin+IL-1 α +OSM-stimulated hGFs did not significantly increase MMP-3 mRNA or protein levels in hGFs at 24 h above that detected for leptin+IL-1-stimulated hGFs (Figure 4.3 and Table 4.3).

4.2.3 Effect of leptin, IL-1 and OSM on the expression of other MMPs and TIMPs in gingival fibroblasts

MMP-2, MMP-7, MMP-9, MMP-13, MMP-14 and TIMP-1 gene expression were assessed by real-time RT-PCR. No synergistic regulation of MMP-2 gene expression was detected in any combination of leptin, IL-1 and OSM-stimulated hGFs (Table 4.2). However, MMP-2 mRNA levels were 3.8-fold reduced in leptin+OSM-stimulated hGFs compared to cells stimulated with leptin at 24 h ($p < 0.05$) (Figure 4.5).

No synergistic regulation of MMP-14 gene expression was detected in any combination of leptin, IL-1 and OSM-stimulated hGFs (Table 4.2) but, MMP-14 mRNA levels in hGFs were significantly increased after leptin+IL-1 α stimulation at 24 h compared to the unstimulated control ($p < 0.001$) (Figure 4.6). MMP-14 gene expression in leptin+IL-1 α -stimulated hGFs was not significantly different from leptin-stimulated hGFs, but was 3.6-fold higher than hGFs stimulated with IL-1 α ($p < 0.01$) (Figure 4.6).

No synergistic regulation of TIMP-1 gene expression was detected in any combination of leptin, IL-1 and OSM-stimulated hGFs (Table 4.2).

MMP-7 and MMP-9 mRNAs were not detected in hGFs basally or after stimulation with any combination of leptin, IL-1 and OSM (Table 4.2). In contrast, MMP-13

mRNA was detected in hGFs stimulated with leptin+IL-1 α at 24 h, but was not detected in any other treatment conditions (Table 4.2).

MMP-10 and TIMP-2 gene expression were determined by semi-quantitative RT-PCR (Figure 4.7). IL-1 α and/or OSM (with or without leptin) appeared to have no ability to increase MMP-10 gene expression in hGFs at 24 h compared to the unstimulated control. In contrast, TIMP-2 expression in leptin+IL-1 α -stimulated hGFs appeared to be reduced compared to either leptin or IL-1 α -stimulated hGFs (at the 10 μ g/ml leptin concentration) (Figure 4.7). Similarly, TIMP-2 expression in OSM (\pm leptin) - stimulated hGFs appeared to be reduced compared to leptin-stimulated hGFs and the unstimulated control, particularly in hGFs stimulated with 0.1 μ g/ml leptin+OSM. Also, TIMP-2 expression in leptin+IL-1 α +OSM-stimulated hGFs appeared to be reduced compared to either leptin or IL-1 α +OSM-stimulated hGFs (at the 10 μ g/ml leptin concentration) (Figure 4.7).

4.3 MMP and TIMP production by gingival fibroblasts after stimulation with leptin and TLR agonists

hGFs were stimulated for 24 h with or without leptin (10 μ g/ml) and:

1. Pam2CSK4 (50 and 100 ng/ml), a TLR2/6 agonist.
2. *E. coli* LPS (10 and 1000 ng/ml), a TLR4 agonist.

These stimuli were chosen as they signal via specific TLRs and because signalling via TLRs regulates MMP production by gingival fibroblasts (Bodet *et al.*, 2007; Herath *et al.*, 2013). Two concentrations of both pam2CSK4 and *E. coli* LPS were used to stimulate hGFs in this study, chosen based on the existing literature and manufacturer recommendations (Nagasawa *et al.*, 2002; Minami *et al.*, 2007; Souza *et al.*, 2010; Morandini *et al.*, 2012). hGFs were either lysed and cDNA prepared by reverse transcription or relative levels of cell proliferation were assessed using a tetrazolium compound-based assay. RT-PCR was used to determine the relative MMP and TIMP gene expression levels after leptin stimulation. MMP concentrations in the supernatants were assessed by ELISA. Unstimulated hGFs at each time point were used as a control, while hGFs treated with DMEM+ were used as a positive control for the proliferation assay.

MMP-1 and MMP-3 protein concentrations for hGFs stimulated with pam2CSK4 were not significantly different between 50 and 100 ng/ml concentrations, and for hGFs

stimulated with LPS were not significantly different between 10 and 1000 ng/ml concentrations (Table 4.4). Subsequently, unless otherwise indicated the results presented in this section correspond to 50 ng/ml pam2CSK4 and 10 ng/ml LPS. A summary of the MMP/TIMP gene expression levels in hGFs after stimulation with 10 µg/ml leptin, 50 ng/ml pam2CSK4 and 10 ng/ml *E. coli* LPS as determined by real-time RT-PCR can be found in Table 4.5.

A similar pattern of response was detected between MMP-3 mRNA and protein levels in hGFs stimulated with leptin and pro-inflammatory cytokines previously (Figures 4.3 and 4.4). Therefore, in this section MMP-3 was only assessed at the protein level by ELISA.

hGF proliferation was significantly increased by pam2CSK4 (50 and 100 ng/ml) ($p < 0.01$), but no similar effect was observed in hGFs stimulated with LPS (10 and 1000 ng/ml) (Figure F.2). Leptin did not synergise with pam2CSK4 (50 and 100 ng/ml) to increase hGF proliferation.

In a separate experiment, hGFs under basal conditions were prepared for flow cytometry (Section 2.2.7). This was performed to assess whether the hGFs used in this study expressed TLR2 or TLR4 on the cell surface.

4.3.1 Leptin and pam2CSK4 synergistically regulate MMP production by gingival fibroblasts

4.3.1.1 MMP-1

Leptin and pam2CSK4 synergised to increase MMP-1 mRNA levels in hGFs (Figure 4.8). MMP-1 expression in leptin+pam2CSK4-stimulated hGFs (33-fold control, $p < 0.001$) was 3-fold higher than leptin and 4-fold higher than pam2CSK4-stimulated hGFs (both $p < 0.05$). To determine whether leptin and pam2CSK4 had a similar effect on MMP-1 secretion, MMP-1 concentrations in leptin and pam2CSK4-stimulated hGF supernatants were assessed. Leptin and pam2CSK4 synergised to increase MMP-1 protein levels in hGFs (Figure 4.9). MMP-1 secretion in leptin+pam2CSK4-stimulated hGFs (23-fold control, $p < 0.001$) was 4-fold higher than leptin and 3-fold higher than pam2CSK4-stimulated hGFs (both $p < 0.001$).

4.3.1.2 MMP-3

Leptin and pam2CSK4 synergised to increase MMP-3 protein levels in hGF supernatants (Table 4.6). In donor 4, MMP-3 was only detected in the supernatants of

hGFs that had been stimulated with leptin+pam2CSK4. In donors 2 and 3, MMP-3 secretion in leptin+pam2CSK4-stimulated hGFs was higher than leptin and pam2CSK4-stimulated hGFs (leptin+pam2CSK4 compared to leptin: donor 2 $p<0.05$, donor 3 $p<0.001$; leptin+pam2CSK4 compared to pam2CSK4: both donors $p<0.001$) (Table 4.6).

4.3.1.3 MMP-14

MMP-14 mRNA levels in hGFs were increased 3.2-fold after leptin+pam2CSK4 stimulation compared to the unstimulated control ($p<0.01$) (Figure 4.10). MMP-14 gene expression in leptin+pam2CSK4-stimulated hGFs was not significantly different from leptin-stimulated hGFs, but was 3.3-fold higher than hGFs stimulated with pam2CSK4 ($p<0.05$).

4.3.1.4 TIMP-1

TIMP-1 gene expression was assessed by real-time RT-PCR. In comparison to the unstimulated control no significant differences in TIMP-1 mRNA levels were observed in pam2CSK4-stimulated hGFs, both in the absence and presence of leptin ($n=12$ from 3 donors stimulated in independent experiments) (Table 4.5).

4.3.1.5 TLR2 surface expression

hGFs isolated from all donors tested expressed TLR2 on the cell surface (Figure 4.11); the median fluorescence intensity (MFI) increased 6.7 ± 0.8 -fold in samples stained for TLR2 compared to the isotype control.

4.3.2 Synergistic regulation of MMP and TIMP production by gingival fibroblasts after stimulation with leptin and *E. coli* LPS

4.3.2.1 MMP-1

Leptin and *E. coli* LPS synergised to increase MMP-1 mRNA levels in a donor-dependent manner (Table 4.7A). MMP-1 expression in leptin+LPS-stimulated hGFs was significantly higher than leptin or LPS-stimulated hGFs (both $p<0.05$) in donor 3; no similar synergy was observed for donors 2 and 4. Leptin and LPS also synergised to increase MMP-1 protein levels in hGFs in a donor-dependent manner (Table 4.7B). MMP-1 secretion in leptin+LPS-stimulated hGFs was significantly higher than leptin or LPS-stimulated hGFs (both $p<0.01$) in donor 3; no similar synergy was observed for donors 2 and 4.

4.3.2.2 MMP-3

Leptin and *E. coli* LPS synergised to increase MMP-3 protein levels in a donor-dependent manner in hGF supernatants (Table 4.8). In donor 3, MMP-3 secretion in leptin+*E. coli*-stimulated hGFs was significantly higher than leptin and *E. coli*-stimulated hGFs (both $p < 0.01$); no significant difference in MMP-3 secretion between leptin and leptin+*E. coli* LPS-stimulated hGFs was observed in donor 2. No MMP-3 protein was detected in any of the supernatants of donor 4 (Table 4.8).

4.3.2.3 MMP-14 and TIMP-1

MMP-14 and TIMP-1 gene expression was assessed by real-time RT-PCR (Table 4.5). No synergistic regulation of MMP-14 expression was observed in hGFs stimulated with leptin+LPS. In comparison to the unstimulated control no significant differences in TIMP-1 mRNA levels were observed in *E. coli* LPS-stimulated hGFs at 24 h, both in the absence and presence of leptin (both $n=12$ from 3 donors stimulated in independent experiments).

4.3.2.4 TLR4 surface expression

TLR4 surface expression on hGFs was assessed to determine whether the donor-dependent responses to LPS were due to the absence or presence of surface TLR4. hGFs isolated from all donors tested expressed TLR4 on the cell surface (Figure 4.12); the median fluorescence intensity (MFI) increased 3.8 ± 0.5 -fold in samples stained for TLR4 compared to the isotype control.

4.4 Discussion

Periodontitis is characterised by destruction of the periodontal tissues (Darveau, 2010). Gingival fibroblasts enhance the production of ECM-degrading MMPs after stimulation with inflammatory mediators (Domeij *et al.*, 2002) or leptin (Chapter 3). Circulating levels of leptin are elevated in obesity and T2DM (Maffei *et al.*, 1995; Coppari and Bjorbaek, 2012); both of these conditions are positively associated with periodontitis (Pischon *et al.*, 2007; Preshaw *et al.*, 2012). Therefore, leptin could act as a molecular link between obesity, T2DM and periodontitis by stimulating the production of MMPs by gingival fibroblasts. Leptin synergises with IL-1 α and TNF- α to enhance the production of MMPs in chondrocytes and cartilage (Koskinen *et al.*, 2011; Hui *et al.*, 2012), yet no studies have investigated whether the production of MMPs by gingival fibroblasts is similarly regulated. However, the cytokines IL-1 α +OSM synergistically

increase MMP-1 production by gingival fibroblasts (Sukkar *et al.*, 2007); a finding confirmed in the present study.

The results presented in this chapter are the first to show that leptin synergised with IL-1 α and the TLR2/6 agonist pam2CSK4 to enhance the production of the collagenase MMP-1 and the stromelysin MMP-3 by gingival fibroblasts. This is the first report of such synergies in any human fibroblasts, and the first report of synergy between leptin and a TLR2 agonist in any primary human cells.

Gene expression of the collagenase MMP-13 increases in gingival fibroblasts after stimulation with IL-1 β at concentrations above and below the 0.05 ng/ml IL-1 α used in the current study (Abe *et al.*, 2001). In contradiction to this, MMP-13 gene expression was only induced in hGFs stimulated with leptin+IL-1 α in this study; no similar induction of MMP-13 gene expression in hGFs was detected after the presumably equally potent leptin+IL-1 α +OSM stimulation. It is difficult to understand the inconsistency between these studies as it is unclear how many donors the results presented by Abe *et al.* (2001) represent. Additionally, in the present study MMP-13 gene expression was only assessed in one hGF donor. Therefore, further analysis of MMP-13 expression in hGFs from other donors may help to understand the regulation of this MMP during hyperleptinaemic and inflammatory conditions. Nonetheless, these studies suggest that under certain stimulatory conditions MMP-13 expression, which is thought to be induced only in RUNX2-expressing osteogenic cells (including PDL fibroblasts (Iwayama *et al.*, 2012)) as described in Section 3.5, can be upregulated in non-osteogenic cell types. If MMP-13 expression was found to be increased in hGFs more consistently, it would be interesting to measure RUNX2 expression to help understand the mechanism behind MMP-13 regulation in these cells.

Increased production of the stromelysin MMP-10 has been observed after IL-1 α +OSM stimulation of chondrocytes and synovial fibroblasts (Barksby *et al.*, 2006), in contradiction to the results presented in this chapter. This disparity may be because MMP-10 gene expression was only determined in one donor using semi-quantitative RT-PCR in this study. Further study of MMP-10 production by quantitative methods and in more donors will be required to better understand the regulation of MMP-10 in gingival fibroblasts, and how this compares to other mesenchymal cells.

Together, these findings have similar implications to those discussed in Section 3.5; leptin may enhance fibrillar collagen degradation in the gingiva as the stromelysin

MMP-3 can activate the collagenase MMP-1 (Burrage *et al.*, 2006). The synergistic increases in MMP-1 and MMP-3 production by gingival fibroblasts described in this chapter add to the results presented in Chapter 3, and suggest that under inflammatory conditions leptin substantially enhances gingival fibroblast-mediated collagen remodelling. Both MMP-1 and MMP-3 target other ECM components (Nagase *et al.*, 2006), and therefore, under inflammatory conditions leptin may also substantially enhance the remodelling of a range of ECM components by gingival fibroblasts.

IL-1 α and IL-1 α +OSM appear to increase MMP-14 gene expression in chondrocytes (although no statistical analysis was performed) (Koshy *et al.*, 2002), which is in contrast to the results of the current study. This inconsistency may be explained by the different concentrations of IL-1 α used (Koshy *et al.* (2002) used 1 ng/ml IL-1 α while 0.05 ng/ml IL-1 α was used in this study) or by the different cell types studied. The lack of regulation of MMP-2 gene expression observed in the results presented in this chapter are in agreement with the evidence that MMP-2 is not highly regulated at the transcriptional level (Burrage *et al.*, 2006). However, the expression of MMP-2 is significantly increased in PDL cells after stimulation with concentrations of IL-1 similar to those used in this study (Xiang *et al.*, 2009); this discrepancy could illustrate a difference between PDL and gingival cells. In this study, TIMP-2 mRNA levels appeared to be lower in hGFs after stimulation with any combination of leptin, IL-1 α and OSM compared to the individual stimuli or unstimulated control. However, TIMP-2 expression was only determined in one donor using semi-quantitative RT-PCR. Further analysis of TIMP-2 production by quantitative methods and in more donors are required to confirm whether leptin, IL-1 and OSM have an additive or synergistic effect on TIMP-2 expression in hGFs. MMP-14, MMP-2 and TIMP-2 are implicated in regulating pericellular ECM remodelling as described in Section 3.5. As combinations of leptin, IL-1 and OSM had no ability to synergistically increase the expression of MMP-14, MMP-2 and TIMP-2, it is possible that this axis of pericellular ECM remodelling by gingival fibroblasts is not enhanced during hyperleptinaemic and inflammatory conditions above that observed in hyperleptinaemia.

Lack of detectable gene expression for the other gelatinase MMP-9 and the matrilysin MMP-7 have been described previously in gingival fibroblasts after stimulation with *P. gingivalis* supernatant (Zhou and Windsor, 2006), which is in agreement with the MMP-9 and MMP-7 expression results in stimulated hGFs in this study. This finding supports the evidence that MMP-9 (as described in Section 3.5) and MMP-7 are

expressed in a cell type-specific manner (Loffek *et al.*, 2011). TNF- α increases MMP-9 secretion from gingival fibroblasts (Beklen *et al.*, 2006), suggesting that MMP-9 production by gingival fibroblasts may be regulated at a level downstream of gene expression.

None of the combinations of leptin, IL-1 α , OSM, pam2CSK4 and LPS had any ability to significantly regulate TIMP-1 expression in hGFs adding to the results of leptin-stimulated TIMP-1 expression presented in Section 3.3.6. Interestingly, TIMP-1 gene expression is increased in IL-1 α +OSM-stimulated bovine cartilage (Milner *et al.*, 2006), and possibly by gingival fibroblasts after stimulation with LPS derived from periodontal pathogens (Bodet *et al.*, 2007). In the study by Bodet *et al.* (2007) no loading control was presented for the immunoblotting used to assess TIMP concentrations therefore it is possible that the results are biased by non-specific changes in protein production after LPS stimulation. The inconsistency between the results in this chapter and the results of Milner *et al.* (2006) regarding TIMP expression are likely to be due to the different cell types/tissue studied. In another study, 1 μ g/ml *E. coli* LPS (which had no effect on TIMP-1 expression in this study) increased TIMP-1 gene expression in gingival fibroblasts (Herath *et al.*, 2013); however, it was not reported whether the results in their study were representative of multiple gingival fibroblast donors. The results in this study imply that under hyperleptinaemic and pro-inflammatory conditions TIMP-1 (and TIMP-2)-mediated inhibition of MMPs by gingival fibroblasts is not increased. However, there are still some inconsistencies in the literature regarding the regulation of TIMPs (TIMP-1 in particular) by gingival fibroblasts and further studies of TIMP expression, secretion and biological activity in hGF cultures are therefore warranted.

IL-1 concentrations (usually IL-1 β) in the gingiva, GCF and saliva are generally positively associated with gingivitis and periodontitis (Preshaw and Taylor, 2011); IL-1 is likely produced after activation of TLRs or other PRRs by microbes in the periodontal plaque biofilm. IL-1 is thought to play a role in the pathogenesis of periodontitis by promoting inflammation and tissue destruction (Preshaw and Taylor, 2011). Gingival fibroblasts express the IL-1 receptor on their surface (Kanda-Nakamura *et al.*, 1996), and IL-1 stimulates a range of responses in gingival fibroblasts relevant to inflammation and tissue homeostasis (Section 1.11). Therefore, IL-1 was used in this study to model one of the signals that fibroblasts are likely exposed to during gingival inflammation.

Numerous bacterial species are positively associated with periodontitis; however no individual microbe has been identified as causal in the pathogenesis of periodontitis (Darveau, 2010). Indeed, current hypotheses suggest that particular polymicrobial communities may determine the pathogenesis of periodontitis (Darveau, 2010). Dental plaque contains both TLR2 and TLR4 agonists (Yoshioka *et al.*, 2008). Some of the well-established periodontal pathogens stimulate inflammatory responses by activating TLR2 (de Aquino *et al.*, 2014). For example, *P. gingivalis* strains express a LPS that stimulates TLR2, but commensal microbes can also activate TLR2 responses (Darveau, 2010). TLR2 (but not TLR4) was found to promote periodontal bone resorption in a model of mouse periodontitis (Burns *et al.*, 2006), which suggests that TLR2 activation promotes deleterious inflammatory responses in the periodontium.

Gingival fibroblasts express multiple TLRs (Section 1.11.2), including TLR2 and TLR4 which were detected on the surface of gingival fibroblasts in this study. It is likely that gingival fibroblasts express surface TLRs to activate inflammatory responses that help kill and clear any microbes in the gingival connective tissue. The approach in this study to stimulate TLR2 and TLR4 responses in gingival fibroblasts was performed in an attempt to model two of the relevant microbial inflammatory signals that exist in the periodontium.

Alone, both IL-1 and pam2CSK4 increased MMP-1 and MMP-3 production by gingival fibroblasts and had no effect on TIMP-1 expression, in agreement with previous studies (see Section 4.1). Therefore, these proinflammatory stimuli (and leptin) may increase gingival fibroblast-derived MMP activity in the gingiva by increasing the MMP:TIMP ratio. A key finding presented in this chapter is the scale of the synergistic upregulation of MMP-1 and MMP-3 production by gingival fibroblasts stimulated with IL-1+leptin and pam2CSK4+leptin. For example, the fold change in MMP-1 expression in leptin+IL-1-stimulated hGFs in this study was approximately 10 times higher than that observed in a previous study in chondrocytes using the same concentrations of leptin and IL-1 (Hui *et al.*, 2012); Hui *et al.* (2012) found that these concentrations of leptin and IL-1 synergistically enhanced collagen degradation in bovine cartilage. Although these results are not entirely comparable, it could be speculated that during simultaneous hyperleptinaemic and inflammatory conditions gingival fibroblasts may promote ECM remodelling at a rate higher than ECM components can be laid down, thereby disturbing ECM homeostasis and promoting deleterious ECM degradation. Therefore, individuals who have gingivitis and are hyperleptinaemic may be more likely

to develop periodontitis. However, ECM components are not the only targets of MMPs; MMPs can also degrade molecules that have pro-inflammatory functions, potentially dampening the inflammatory response (Page-McCaw *et al.*, 2007). Three-dimensional *ex vivo* or *in vivo* models of ECM degradation in the gingiva during hyperleptinaemic and inflammatory conditions may help to provide information regarding the functional relevance of elevated gingival fibroblast-derived MMPs.

One previous study stimulated gingival fibroblasts with leptin and *E. coli* LPS, and found that these stimuli do not synergistically regulate IL-6 and CXCL8 production (Park *et al.*, 2013); although the number of donors tested was not reported. Unlike the other inflammatory mediators tested in this study, the ability of *E. coli* LPS (alone and in combination with leptin) to regulate MMP production by gingival fibroblasts was donor-dependent. As such, this is the first report that leptin and *E. coli* LPS can synergistically regulate MMP production in gingival fibroblasts (albeit in a single donor).

Cell surface levels of TLR4 on immune cells and synovial fibroblasts are modulated by cytokines and LPS respectively (Mita *et al.*, 2002; He *et al.*, 2013). Therefore, *E. coli* LPS responses could vary between gingival fibroblasts from different donors because surface expression of TLR4 is altered. In this study, TLR4 was expressed on gingival fibroblasts from all donors tested, including those that did not regulate MMP production in response to LPS. This suggests that a lack of TLR4 surface expression was not the reason why gingival fibroblasts from two of the three donors tested did not respond to LPS.

Fibroblasts from different areas of the periodontium have different phenotypes (Irwin *et al.*, 1994; Jonsson *et al.*, 2011), and donor-donor variability has been described in other studies of gingival fibroblasts (Tipton *et al.*, 1991; Sukkar *et al.*, 2007; Uehara and Takada, 2007). Another possible reason that in this study the gingival fibroblast response to LPS varied could be because an anatomically and/or phenotypically distinct gingival fibroblast population was isolated and selected from the gingival tissue donated by the individual that responded to *E. coli* LPS. Future studies of LPS responses by gingival fibroblasts from more donors and an extensive phenotyping of the isolated gingival fibroblasts may help to identify how often varied responses to LPS occur, and whether any particular fibroblast populations are involved.

Sensitivity to LPS varies between individuals (Michel *et al.*, 2001; Wurfel *et al.*, 2005). Together with the results in this study, this suggests that the ability of leptin to determine ECM remodelling during microbial-derived inflammation in the gingiva may be dependent on individual LPS sensitivity. The identification of the genetic or environmental basis for this finding may help to elucidate individual risks in the hyperleptinaemic population for developing periodontitis.

Overall, the results presented in this chapter demonstrated that leptin synergises with IL-1 and pam2CSK4 to regulate specific MMPs (MMP-1 and MMP-3) in gingival fibroblasts. A different MMP (MMP-13) is synergistically regulated by leptin and pro-inflammatory cytokines in chondrocytes (Hui *et al.*, 2012), which adds to the idea discussed in Section 3.5 that gingival fibroblasts have an innate ability to determine which MMPs are subject to regulation. Not all the MMPs (e.g. MMP-14) upregulated by leptin were synergistically regulated by leptin in combination with these proinflammatory mediators. Together, these findings indicate that the regulation of MMP (and TIMP) expression in gingival fibroblasts during inflammatory and hyperleptinaemic conditions requires the intracellular integration of multiple signals at the same time. Mechanisms that may determine how MMP production is synergistically regulated in gingival fibroblasts include activating multiple signalling pathways/transcription factors that converge on MMP promoters to maximise gene expression, or increasing multiple processes in the pathway of MMP production (e.g. increasing transcription, translation and secretion rates). For example, cytokines increase MMP mRNA stability (Loffek *et al.*, 2011); perhaps this complements the regulatory action of leptin on MMP production.

One previous study investigating leptin and OSM in combination found that leptin promoted cartilage collagen degradation independent of whether OSM was present (Hui *et al.*, 2012). Similarly, in the present study leptin and OSM did not synergistically increase MMP-1 or MMP-3 production by gingival fibroblasts; however OSM alone did significantly increase MMP-1 production. Leptin and OSM are both members of the IL-6 cytokine family and share several characteristics; for example, both leptin and OSM activate the JAK/STAT intracellular signalling pathway (Taga and Kishimoto, 1997b). The MMP-1 promoter requires binding of transcription factors derived from several intracellular signalling pathways to promote maximal gene expression (Vincenti and Brinckerhoff, 2002). Therefore, it is possible that leptin and OSM regulate MMP-1 production by activating the same signalling pathways resulting in the activation of the

same transcription factors. As such, leptin and OSM may regulate MMP production by gingival fibroblasts in a redundant manner. OSM is present in GCF albeit at levels not significantly different between health and periodontitis (Lin *et al.*, 2005; Becerik *et al.*, 2012). This suggests that OSM is present in the gingiva, and therefore, that leptin may have no effect on MMP production by gingival fibroblasts *in vivo*. In this study OSM did not promote MMP-3 production by gingival fibroblasts, in contrast to leptin. This suggests that leptin and OSM do not function redundantly regarding the regulation of MMP-3 production by gingival fibroblasts, although only one OSM concentration was tested. Further work assessing how a range of OSM concentrations affect MMP production by gingival fibroblasts would help to address this possibility.

Leptin activates a number of intracellular signalling pathways that are implicated in regulating MMP production (Section 1.10). Similarly, IL-1 and TLR2 agonists activate multiple intracellular signalling pathways, including the NF- κ B and MAPK pathways (Bowie and O'Neill, 2000). The MMP-1 and MMP-3 promoters contain NF- κ B binding sites (Fanjul-Fernandez *et al.*, 2010), suggesting that the synergistic upregulation of MMP-1 and MMP-3 in gingival fibroblasts could be due to a NF- κ B-mediated increase in gene expression. However, the MMP-14 promoter also contains an NF- κ B binding site and was not synergistically regulated in this study (Fanjul-Fernandez *et al.*, 2010), suggesting that other critical factors not activated by leptin are required for MMP-14 upregulation, or that increased NF- κ B activity is not sufficient for synergistic increases in MMP-1/3 expression in gingival fibroblasts. The MMP-1 and MMP-3 promoters have two binding sites for the transcription factor AP-1, while most other MMP promoters only have one (Fanjul-Fernandez *et al.*, 2010). The MMP-9 promoter is an exception to this as it has three AP-1 binding sites, but as discussed previously MMP-9 appears to be regulated by cell-type specific transcription factors (e.g. RUNX2) (Fanjul-Fernandez *et al.*, 2010). Increased expression of the proteins which AP-1 comprises (e.g. c-Fos, c-Jun), and increased AP-1 activity are promoted by the MAPK signalling pathway (Hess *et al.*, 2004); leptin, IL-1 and pam2CSK4 all activate the MAPK signalling pathway (Section 1.2) (Toshchakov *et al.*, 2005). Therefore, leptin and IL-1 or pam2CSK4 could synergistically regulate MMP-1 and MMP-3 production in gingival fibroblasts by amplifying AP-1-mediated MMP gene expression.

In this study leptin and OSM increased MMP-14 gene expression, while IL-1 α and pam2CSK4 had no similar effect. This suggests that members of the IL-6 cytokine family regulate MMP-14 gene expression in a manner distinct to that of other

inflammatory stimuli. Mechanistically, this could be regulated via the activation of signalling pathways (e.g. JAK/STAT) which IL-6 family cytokines, but not IL-1 or TLR2 agonists, stimulate (Taga and Kishimoto, 1997b). However, the MMP-14 promoter does not contain a STAT binding site (Fanjul-Fernandez *et al.*, 2010). Interestingly, the MMP-14 promoter also lacks binding sites for AP-1 and other transcription factors that are important for regulating the expression of MMPs (Lohi *et al.*, 2000) (Fanjul-Fernandez *et al.*, 2010). MMP-14 was not synergistically regulated in this study and together this supports the idea discussed above that AP-1 activity could be involved in determining synergistic regulation of MMPs in gingival fibroblasts.

IL-1, TLR2 and TLR4 all activate the same canonical signalling events e.g. the NF- κ B signalling pathway in a MyD88-dependent manner (Bowie and O'Neill, 2000). As *E. coli* LPS failed to reproducibly synergise with leptin, this suggests that the canonical TLR/IL-1 intracellular signalling pathway may not regulate the synergy observed between leptin and IL-1/pam2CSK4 in hGFs. Alternatively, somewhere along the complex intracellular signalling pathways activated in IL-1 and pam2CSK4-stimulated hGFs molecules unique to these stimuli are activated or available which are not similarly utilised after *E. coli* LPS stimulation (except in hGFs from the responsive donor). For example, TLR2 and TLR4 have a differential ability to activate IRF transcription factors (Jung *et al.*, 2005), and a differential requirement for TIR domain-containing adaptor proteins which interact with the intracellular tail of TLRs (Toshchakov *et al.*, 2005).

Clearly, further studies that investigate the likely multiple and complicated intracellular mechanisms behind these synergies are warranted. One approach to investigate this would be to use chemical inhibitors or siRNA to specifically target molecules within intracellular signalling pathways in the aim to identify which pathways/molecules are required to enhance MMP gene expression in hGFs stimulated with leptin and inflammatory mediators (Chapter 5).

In conclusion, the results in this chapter provide the first evidence that gingival fibroblast-mediated ECM remodelling may be synergistically enhanced during hyperleptinaemia and inflammation. These results support the hypothesis that leptin is a molecular link between conditions associated with hyperleptinaemia (e.g. obesity, T2DM) and periodontitis.

Further lines of work could be pursued in relation to the results presented in this chapter. Numerous other endogenous and exogenous molecules (including anti-inflammatory molecules) regulate MMP and TIMP production by gingival fibroblasts (Domeij *et al.*, 2002; Matsushita *et al.*, 2006; Sukkar *et al.*, 2007; Zhang *et al.*, 2011; Kuo *et al.*, 2012; Ujii *et al.*, 2012). Therefore, it is unknown whether the synergistic regulation of MMP-1 and MMP-3 by leptin and IL-1/TLR2 agonists in gingival fibroblasts is relevant to gingival ECM remodelling *in vivo* where other stimuli will also be present. This could be addressed by using *in vivo* or 3D tissue models where a more genuine inflammatory response could be induced (Chapter 7).

Table 4.1: MMP and TIMP expression in hGFs after stimulation with leptin (0.1 µg/ml), IL-1 and OSM.

Supernatants were collected and cDNA was prepared from hGFs after stimulation with leptin (0.1 µg/ml), IL-1α (0.05 ng/ml), leptin+IL-1α (leptin 0.1 µg/ml, IL-1α 0.05 ng/ml), OSM (5 ng/ml), leptin+OSM (leptin 0.1 µg/ml, OSM 5 ng/ml), IL-1α+OSM (IL-1α 0.05 ng/ml, OSM 5 ng/ml) and leptin+IL-1α+OSM (leptin 0.1 µg/ml, IL-1α 0.05 ng/ml, OSM 5 ng/ml) for 24 h. Real-time RT-PCR was used to assess MMP/TIMP and RNAP gene expression. Relative MMP/TIMP gene expression was determined using the $2^{-\text{ddCt}}$ method by using RNAP as the reference gene. Data (fold unstimulated control) are shown as mean±SD or median (IQR) (n=12) from three donors stimulated in independent experiments. MMP-13, MMP-9 and MMP-7 gene expression was not detected in hGFs after any treatment conditions (n=4, one donor). ND – not detected. Statistics: T tests for independent samples or Mann-Whitney U test (Bonferroni-corrected). For clarity no indications of significance are displayed in this table; however, selected p values are indicated in the relevant body text or figure.

		IL-1			OSM		IL-1+OSM	
0.1 µg/ml leptin		+	-	+	-	+	-	+
Collagenase	MMP-1	1.22 (0.92-3.58)	6.75 (3.80-8.89)	6.15 (4.72-11.6)	6.06 (3.56-10.4)	6.37 (3.47-12.7)	104 (63-173)	94.2 (70.5-146)
	MMP-13	ND	ND	ND	ND	ND	ND	ND
Gelatinase	MMP-2	1.84 ±1.65	1.18 ±0.86	1.93 ±1.51	1.36 ±1.19	2.00 ±2.99	2.84 ±1.44	1.60 ±1.10
	MMP-9	ND	ND	ND	ND	ND	ND	ND
Matrilysin	MMP-7	ND	ND	ND	ND	ND	ND	ND
MT-MMP		1.29	1.25	2.07	3.33	0.95	2.72	2.31
	MMP-14	(0.37-2.45)	(0.65-1.92)	(1.77-2.62)	(1.81-4.87)	(0.18-5.82)	(1.45-6.73)	(0.52-11.3)
TIMPs	TIMP-1	1.13 ±0.47	0.994 ±0.398	1.16 ±0.40	1.13 ±0.45	1.00 ±0.79	1.35 ±1.29	6.33 ±17.5

Table 4.2: MMP and TIMP expression in hGFs after stimulation with leptin (10 µg/ml), IL-1 and OSM.

Supernatants were collected and cDNA was prepared from hGFs after stimulation with leptin (10 µg/ml), IL-1α (0.05 ng/ml), leptin+IL-1α (leptin 10 µg/ml, IL-1α 0.05 ng/ml), OSM (5 ng/ml), leptin+OSM (leptin 10 µg/ml, OSM 5 ng/ml), IL-1α+OSM (IL-1α 0.05 ng/ml, OSM 5 ng/ml) and leptin+IL-1α+OSM (leptin 10 µg/ml, IL-1α 0.05 ng/ml, OSM 5 ng/ml) for 24 h. Real-time RT-PCR was used to assess MMP/TIMP and RNAP gene expression. Relative MMP/TIMP gene expression was determined using the $2^{-\text{ddCt}}$ method by using RNAP as the reference gene. Data (fold unstimulated control) are shown as mean±SD or median (IQR) (n=12) from three donors stimulated in independent experiments. MMP-9 and MMP-7 gene expression was not detected in hGFs after any treatment conditions (n=4, one donor); MMP-13 was only detected in hGFs stimulated with leptin+IL-1 (indicated by +). ND – not detected. Statistics: T tests for independent samples or Mann-Whitney U test (Bonferroni-corrected). For clarity no indications of significance are displayed in this table; however, selected p values are indicated in the relevant body text or figure.

		IL-1			OSM		IL-1+OSM	
10 µg/ml leptin		+	-	+	-	+	-	+
Collagenase	MMP-1	12.1 (11.0-16.2)	6.75 (3.80-8.89)	191 (147-424)	6.06 (3.56-10.4)	10.6 (8.56-16.7)	104 (63-173)	278 (166-480)
	MMP-13	ND	ND	+	ND	ND	ND	ND
Gelatinase	MMP-2	3.65 ±2.82	1.18 ±0.86	6.79 ±7.05	1.36 ±1.19	0.971 ±1.00	2.84 ±1.44	2.64 ±2.09
	MMP-9	ND	ND	ND	ND	ND	ND	ND
Matrilysin	MMP-7	ND	ND	ND	ND	ND	ND	ND
MT-MMP		3.64	1.25	3.78	3.33	4.11	2.72	3.46
	MMP-14	(2.62-7.98)	(0.65-1.92)	(2.95-7.23)	(1.81-4.87)	(0.37-12.1)	(1.45-6.73)	(1.94-8.60)
TIMPs	TIMP-1	1.84 ±2.10	0.994 ±0.398	0.920 ±0.408	1.13 ±0.45	1.22 ±0.81	1.35 ±1.29	1.19 ±0.82

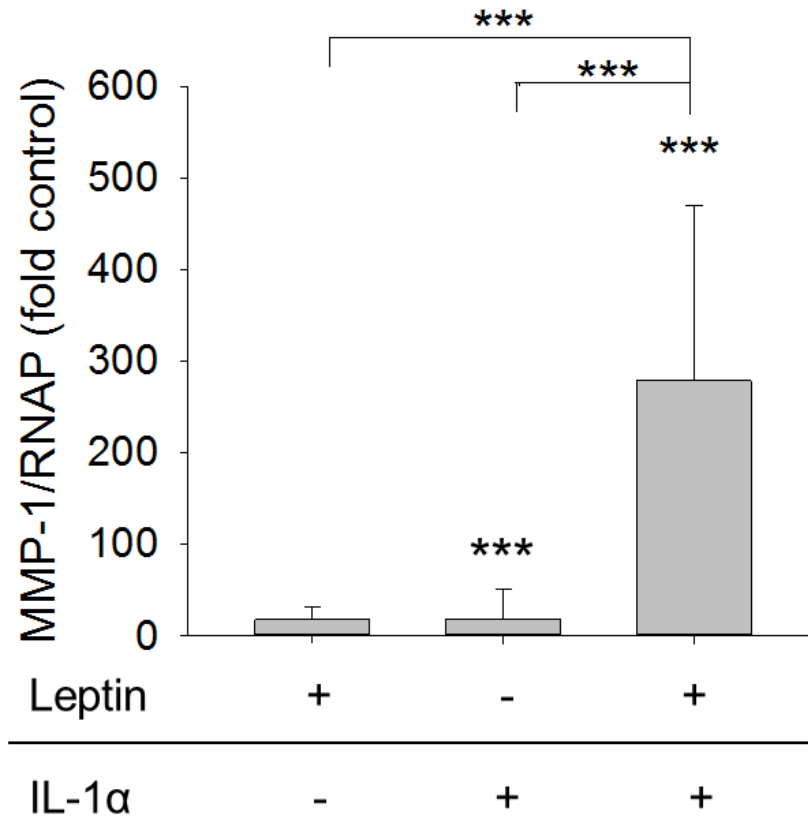

Figure 4.1: MMP-1 gene expression in hGFs after stimulation with leptin and IL-1α.

hGFs were stimulated with leptin (10 µg/ml), IL-1α (0.05 ng/ml) or leptin+IL-1α (leptin 10 µg/ml, IL-1α 0.05 ng/ml) for 24 h. Cells were lysed and cDNA was prepared by reverse transcription. Real-time RT-PCR was used to assess MMP-1 and RNAP gene expression. Relative MMP-1 gene expression was determined using the 2^{-ddCt} method by using RNAP as the reference gene. Data (fold unstimulated control) are shown as mean+SD (n=12) from three donors stimulated in independent experiments. Statistics: T tests for independent samples (Bonferroni-corrected) ***=p<0.001 compared to unstimulated control unless otherwise indicated.

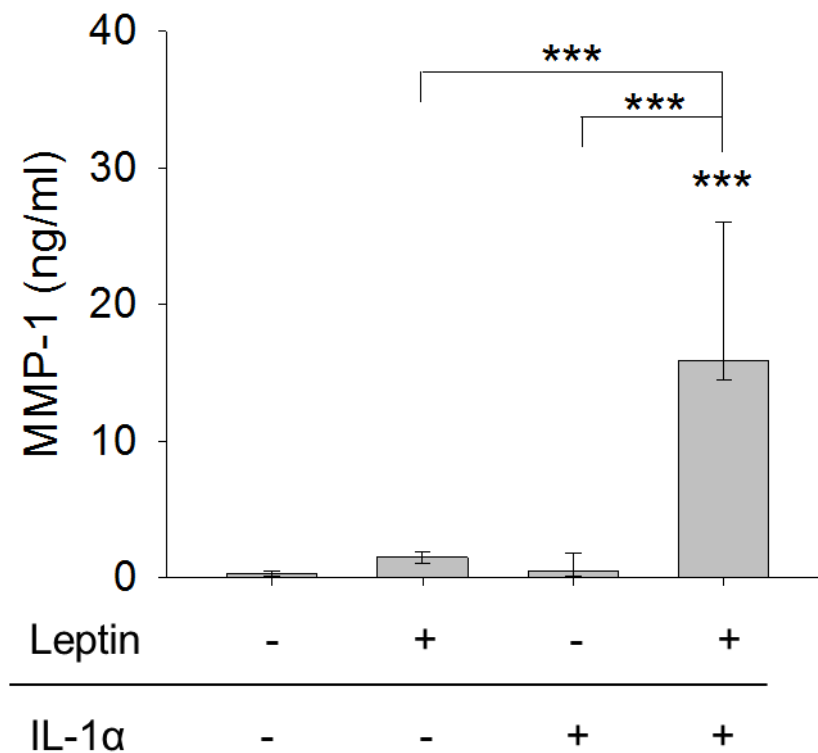

Figure 4.2: MMP-1 protein secretion by hGFs after stimulation with leptin and IL-1α.

hGFs were stimulated with leptin (10 µg/ml), IL-1α (0.05 ng/ml) or leptin+IL-1α (leptin 10 µg/ml, IL-1α 0.05 ng/ml) for 24 h. Supernatants were collected and MMP-1 concentrations were assessed by ELISA. Data are shown as median+IQR (n=12) from three donors stimulated in independent experiments. Statistics: Mann-Whitney U test for independent samples (Bonferroni-corrected) ***=p<0.001 compared to unstimulated control unless otherwise indicated.

Table 4.3: MMP-1 and MMP-3 secretion by hGFs after stimulation with leptin (10 µg/ml), IL-1 and OSM.

Supernatants were collected and cDNA was prepared from hGFs after stimulation with leptin (10 µg/ml), IL-1α (0.05 ng/ml), leptin+IL-1α (leptin 10 µg/ml, IL-1α 0.05 ng/ml), OSM (5 ng/ml), leptin+OSM (leptin 10 µg/ml, OSM 5 ng/ml), IL-1α+OSM (IL-1α 0.05 ng/ml, OSM 5 ng/ml) and leptin+IL-1α+OSM (leptin 10 µg/ml, IL-1α 0.05 ng/ml, OSM 5 ng/ml) for 24 h. Supernatants were collected and MMP1 and MMP-3 concentrations were assessed by ELISA. Data are shown as median (IQR) or mean ±SD (n=12) from three donors stimulated in independent experiments. ND – not detected. Statistics: T tests for independent samples or Mann-Whitney U test (Bonferroni-corrected). For clarity no indications of significance are displayed in this table; however, selected p values are indicated in the relevant body text or figure.

				IL-1		OSM		IL-1+OSM	
10 µg/ml leptin		-	+	-	+	-	+	-	+
Collagenase	MMP-1	0.266 (0.128-0.515)	1.49 (1.02-1.93)	0.501 (0.116-1.75)	15.9 (14.5-26.0)	0.444 (0.230-1.23)	1.28 (0.90-3.62)	4.32 (0.79-9.73)	17.4 (11.9-36.0)
Stromelysin	MMP-3	ND	0.171 ±0.060	0.211 ±0.062	2.73 ±1.21	ND	0.208 ±0.060	0.323 ±0.310	2.60 ±1.20

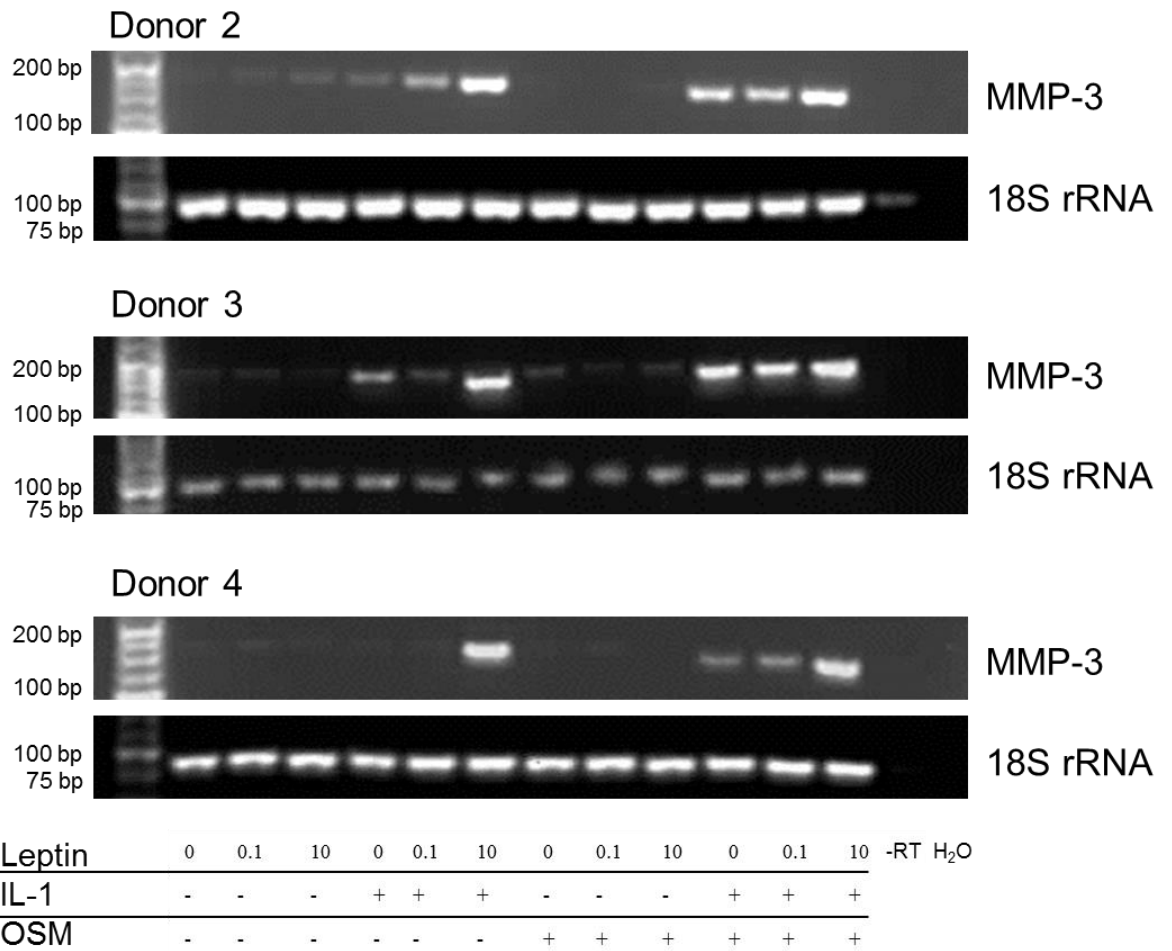

Figure 4.3: MMP-3 gene expression in hGFs after stimulation with leptin, IL-1 α and OSM.

hGFs were stimulated with leptin (0.1 or 10 $\mu\text{g/ml}$), IL-1 α (0.05 ng/ml), OSM (5 ng/ml), leptin+IL-1 α (leptin 0.1 or 10 $\mu\text{g/ml}$, IL-1 α 0.05 ng/ml), leptin+OSM (leptin 0.1 or 10 $\mu\text{g/ml}$, OSM 5 ng/ml) or leptin+IL-1 α +OSM (leptin 0.1 or 10 $\mu\text{g/ml}$, IL-1 α 0.05 ng/ml, OSM 5 ng/ml) for 24 h. Cells were lysed and cDNA was prepared by reverse transcription. Semi-quantitative RT-PCR was used to assess MMP-3 mRNA and 18S rRNA expression. The expected product size for MMP-3 was 150 bp, and for 18S rRNA was 85 bp. This experiment was performed in three donors (donors 2-4) and the results for each are displayed.

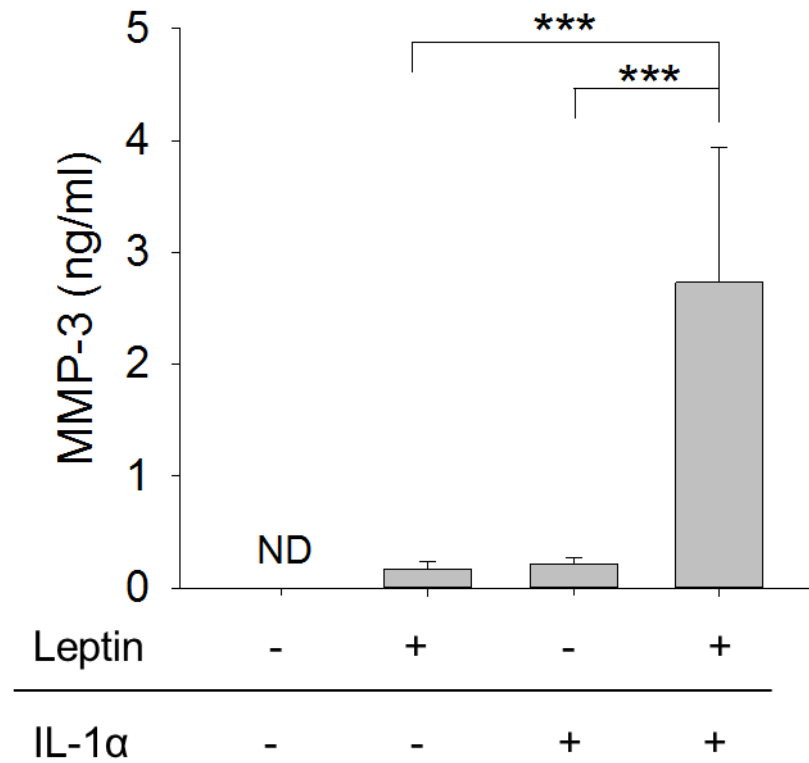

Figure 4.4: MMP-3 protein secretion by hGFs after stimulation with leptin and IL-1α.

hGFs were stimulated with leptin (10 µg/ml), IL-1α (0.05 ng/ml) or leptin+IL-1α (leptin 10 µg/ml, IL-1α 0.05 ng/ml) for 24 h. Supernatants were collected and MMP-3 concentrations were assessed by ELISA. Data are shown as mean+SD (n=12) from three donors stimulated in independent experiments. ND – not detected. Statistics: T tests for independent samples (Bonferroni-corrected) ***=p<0.001 for comparisons as indicated.

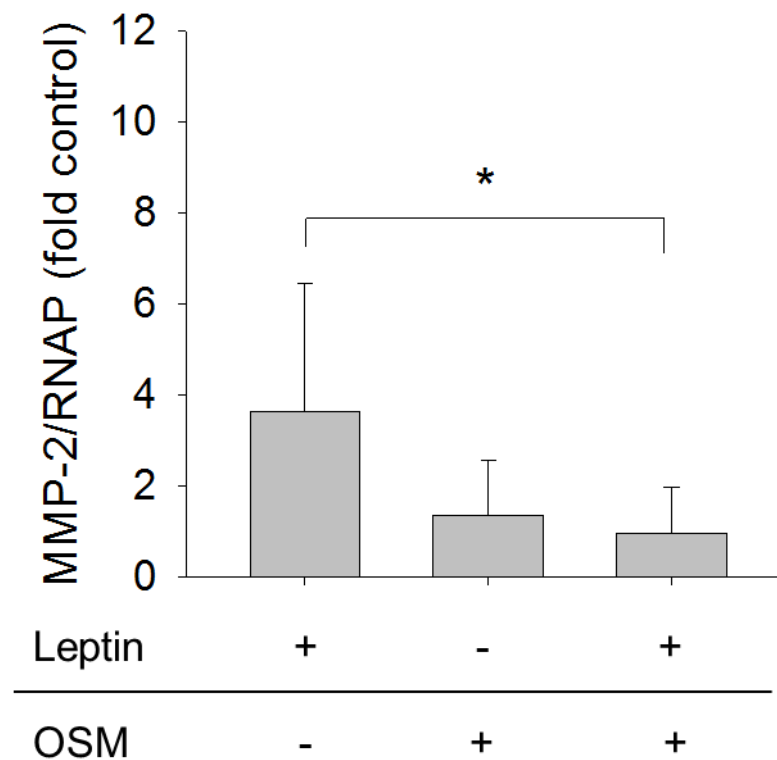

Figure 4.5: MMP-2 gene expression in hGFs after stimulation with leptin and OSM.

hGFs were stimulated with leptin (10 $\mu\text{g/ml}$), OSM (5 ng/ml) or leptin+OSM (leptin 10 $\mu\text{g/ml}$, OSM 5 ng/ml) for 24 h. Cells were lysed and cDNA was prepared by reverse transcription. Real-time RT-PCR was used to assess MMP-2 and RNAP gene expression. Relative MMP-2 gene expression was determined using the $2^{-\text{ddCt}}$ method by using RNAP as the reference gene. Data (fold unstimulated control) are shown as mean+SD (n=12) from three donors stimulated in independent experiments. Statistics: T tests for independent samples (Bonferroni-corrected) $^* = p < 0.05$ as indicated.

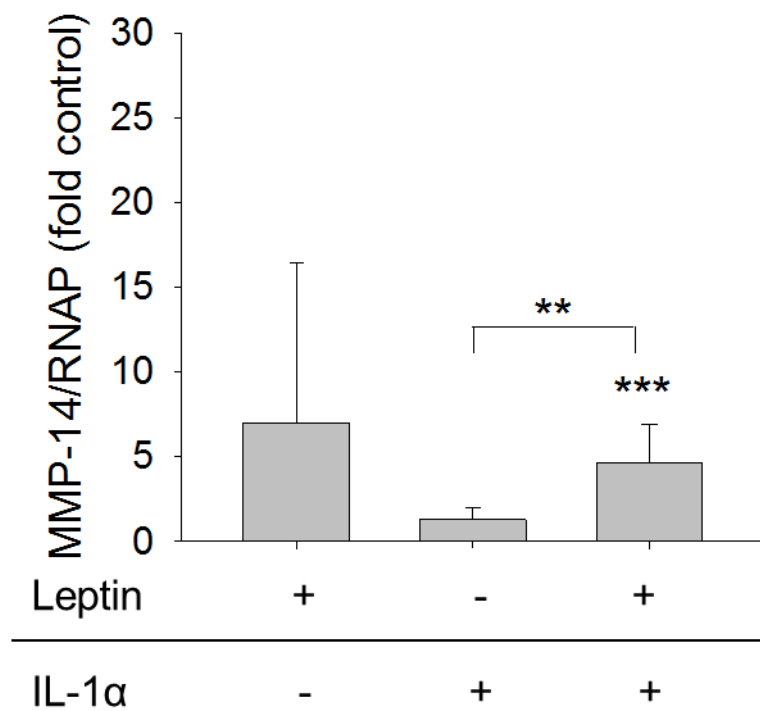

Figure 4.6: MMP-14 gene expression in hGFs after stimulation with leptin and IL-1 α .

hGFs were stimulated with leptin (10 μ g/ml), IL-1 α (0.05 ng/ml) or leptin+IL-1 α (leptin 10 μ g/ml, IL-1 α 0.05 ng/ml) for 24 h. Cells were lysed and cDNA was prepared by reverse transcription. Real-time RT-PCR was used to assess MMP-14 and RNAP gene expression. Relative MMP-14 gene expression was determined using the 2^{-ddCt} method by using RNAP as the reference gene. Data (fold unstimulated control) are shown as mean+SD (n=12) from three donors stimulated in independent experiments. Statistics: T tests for independent samples (Bonferroni-corrected) **=p<0.01, ***=p<0.001 compared to unstimulated control unless otherwise indicated.

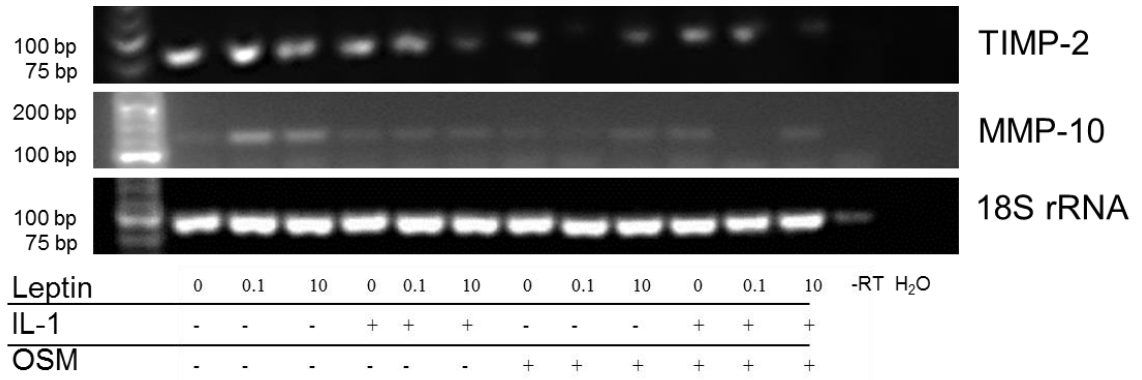

Figure 4.7: TIMP-2 and MMP-10 gene expression in hGFs after stimulation with leptin, IL-1 α and OSM.

hGFs from one donor were stimulated with leptin (0.1 or 10 $\mu\text{g/ml}$), IL-1 α (0.05 ng/ml), OSM (5 ng/ml), leptin+IL-1 α (leptin 0.1 or 10 $\mu\text{g/ml}$, IL-1 α 0.05 ng/ml), leptin+OSM (leptin 0.1 or 10 $\mu\text{g/ml}$, OSM 5 ng/ml) or leptin+IL-1 α +OSM (leptin 0.1 or 10 $\mu\text{g/ml}$, IL-1 α 0.05 ng/ml, OSM 5 ng/ml) for 24 h. Cells were lysed and cDNA was prepared by reverse transcription. Semi-quantitative RT-PCR was used to assess TIMP-2 and MMP-10 mRNA and 18S rRNA expression. The expected product size for TIMP-2 was 77 bp, for MMP-10 was 113 bp, and for 18S rRNA was 85 bp.

Table 4.4: MMP-1 and MMP-3 secretion by hGFs after stimulation with two concentrations of pam2CSK4 or *E. coli* LPS.

hGFs were stimulated with leptin (10 µg/ml), pam2CSK4 (50 or 100 ng/ml), leptin+pam2CSK4 (leptin 10 µg/ml, pam2CSK4 50 or 100 ng/ml), *E. coli* LPS (10 or 1000 ng/ml) and leptin+*E. coli* LPS (leptin 10 µg/ml, *E. coli* LPS 10 or 1000 ng/ml) for 24 h. Supernatants were collected and MMP1 and MMP-3 concentrations were assessed by ELISA. Data are shown as mean ±SD or median (IQR) (n=12) fold control (MMP-1) or concentration in ng/ml (MMP-3) from three donors stimulated in independent experiments. Statistics: T tests for independent samples or Mann-Whitney U test (Bonferroni-corrected).

		Basal	pam2CSK4				<i>E. coli</i> LPS			
			50	100	50	100	10	1000	10	1000
10 µg/ml leptin		-	-	-	+	+	-	-	+	+
Collagenase	MMP-1	1.00 ±0.16	5.59 ±2.90	5.60 ±2.85	19.8 ±4.5	20.2 ±5.6	2.27 ±2.16	2.19 ±2.14	8.41 ±3.41	6.79 ±2.90
Stromelysin	MMP-3	0.00 (0.00-0.377)	1.87 (0.00-2.24)	1.65 (0.00-2.52)	3.63 (0.15-3.93)	4.02 (0.25-4.20)	0.00 (0.00-1.59)	0.135 (0.00-1.59)	0.396 (0.00-2.81)	0.368 (0.00-2.57)

Table 4.5: MMP and TIMP expression in hGFs after stimulation with leptin, pam2CSK4 and *E. coli* LPS.

Supernatants were collected and cDNA was prepared from hGFs after stimulation with leptin (10 µg/ml), pam2CSK4 (50 ng/ml), leptin+pam2CSK4 (leptin 10 µg/ml, pam2CSK4 50 ng/ml), *E. coli* LPS (10 ng/ml) and leptin+*E. coli* LPS (leptin 10 µg/ml, *E. coli* LPS 10 ng/ml) for 24 h. Real-time RT-PCR was used to assess MMP/TIMP and RNAP gene expression. Relative MMP/TIMP gene expression was determined using the $2^{-\Delta\Delta C_t}$ method by using RNAP as the reference gene. Data (fold unstimulated control) are shown as mean±SD (n=12) from three donors stimulated in independent experiments. MMP-1 expression in LPS-stimulated hGFs was donor dependent and these results are presented in Table 4.7. Statistics: T tests for independent samples (Bonferroni-corrected). For clarity no indications of significance are displayed in this table; however, selected p values are indicated in the relevant body text or figure.

		pam2CSK4			<i>E. coli</i> LPS	
10 µg/ml leptin		+	-	+	-	+
Collagenase	MMP-1	9.76 ±2.34	8.67 ±6.47	33.2 ±16.4	Donor-dependent	
MT-MMP	MMP-14	2.17 ±2.07	0.97 ±0.74	3.19 ±2.08	1.35 ±1.48	1.78 ±0.72
TIMPs	TIMP-1	1.14 ±0.43	1.01 ±0.33	1.26 ±0.50	1.03 ±0.35	1.09 ±0.89

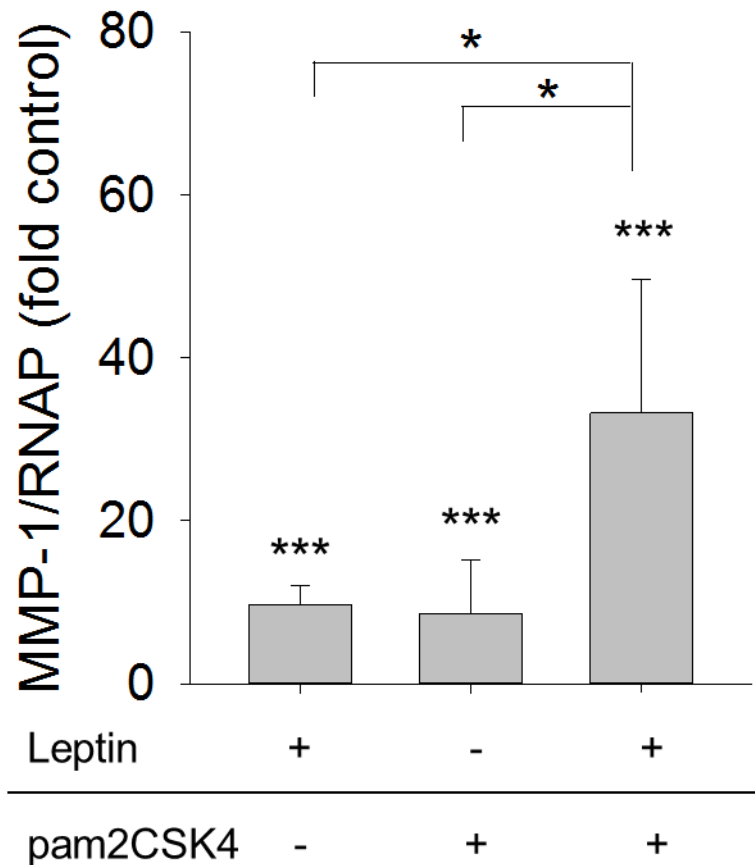

Figure 4.8: MMP-1 gene expression in hGFs after stimulation with leptin and pam2CSK4.

hGFs were stimulated with leptin (10 $\mu\text{g/ml}$), pam2CSK4 (50 ng/ml) or leptin+pam2CSK4 (leptin 10 $\mu\text{g/ml}$, pam2CSK4 50 ng/ml) for 24 h. Cells were lysed and cDNA was prepared by reverse transcription. Real-time RT-PCR was used to assess MMP-1 and RNAP gene expression. Relative MMP-1 mRNA expression was determined using the $2^{-\text{ddCt}}$ method by using RNAP as the reference gene. Data (fold unstimulated control) are shown as mean+SD (n=12) from three donors stimulated in independent experiments. Statistics: T tests for independent samples (Bonferroni-corrected) $*=p<0.05$, $***=p<0.001$ compared to unstimulated control unless otherwise indicated.

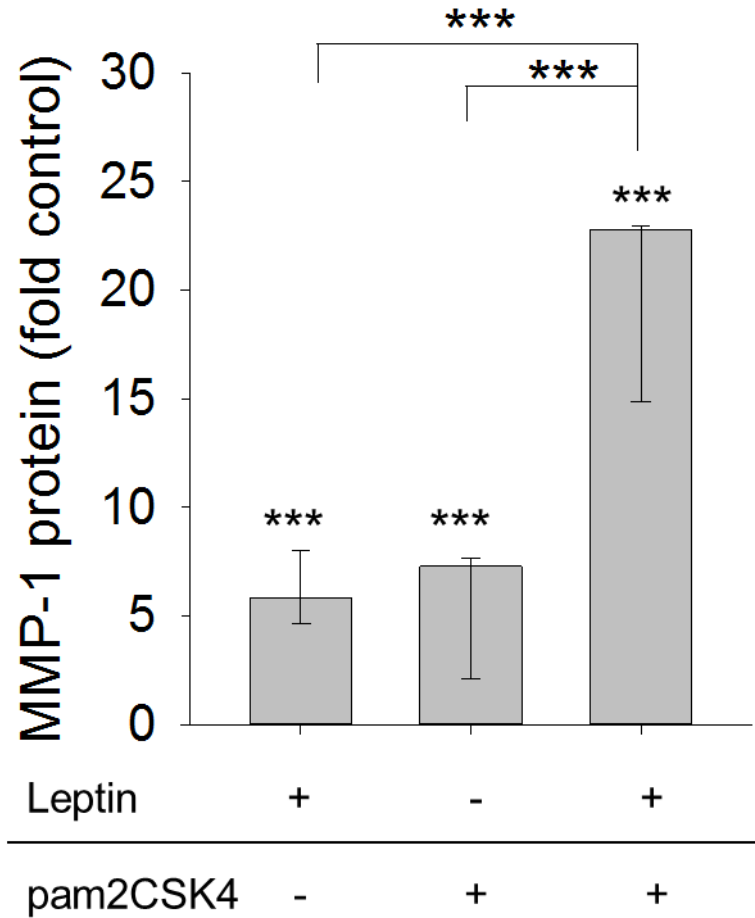

Figure 4.9: MMP-1 protein secretion by hGFs after stimulation with leptin and pam2CSK4.

hGFs were stimulated with leptin (10 µg/ml), pam2CSK4 (50 ng/ml) or leptin+pam2CSK4 (leptin 10 µg/ml, pam2CSK4 50 ng/ml) for 24 h. Supernatants were collected and MMP-1 concentrations were assessed by ELISA. Data (fold unstimulated control) are shown as median+IQR (n=12) from three donors stimulated in independent experiments. Statistics: Mann-Whitney U test for independent samples (Bonferroni-corrected) ***=p<0.001 compared to unstimulated control unless otherwise indicated.

Table 4.6: MMP-3 protein secretion by hGFs stimulated with leptin and pam2CSK4.

hGFs were stimulated with leptin (10 µg/ml), pam2CSK4 (50 ng/ml) or leptin+pam2CSK4 (leptin 10 µg/ml, pam2CSK4 50 ng/ml) for 24 h. Supernatants were collected and analysed for MMP-3 by ELISA. Data is presented as the mean±SD (n=4) MMP-3 concentration (ng/ml) for each donor tested by treatment condition. ND – not detected. Statistics: T tests for independent samples (Bonferroni-corrected) **=p<0.01, ***=p<0.001 compared to unstimulated control; # p<0.05, ###=p<0.001 compared to leptin-stimulated hGFs; \$\$\$=p<0.001 compared to pam2CSK4-stimulated hGFs.

	Unstimulated control	Leptin	Pam2CSK4	Leptin+pam2CSK4
Donor 2	ND	0.44 ± 0.06	1.89 ± 0.40	4.06 ± 0.16 ^{###}
Donor 3	0.43 ± 0.07	1.76 ± 0.51 ^{**}	2.19 ± 0.31 ^{***}	3.65 ± 0.20 ^{####}
Donor 4	ND	ND	ND	0.15 ± 0.01

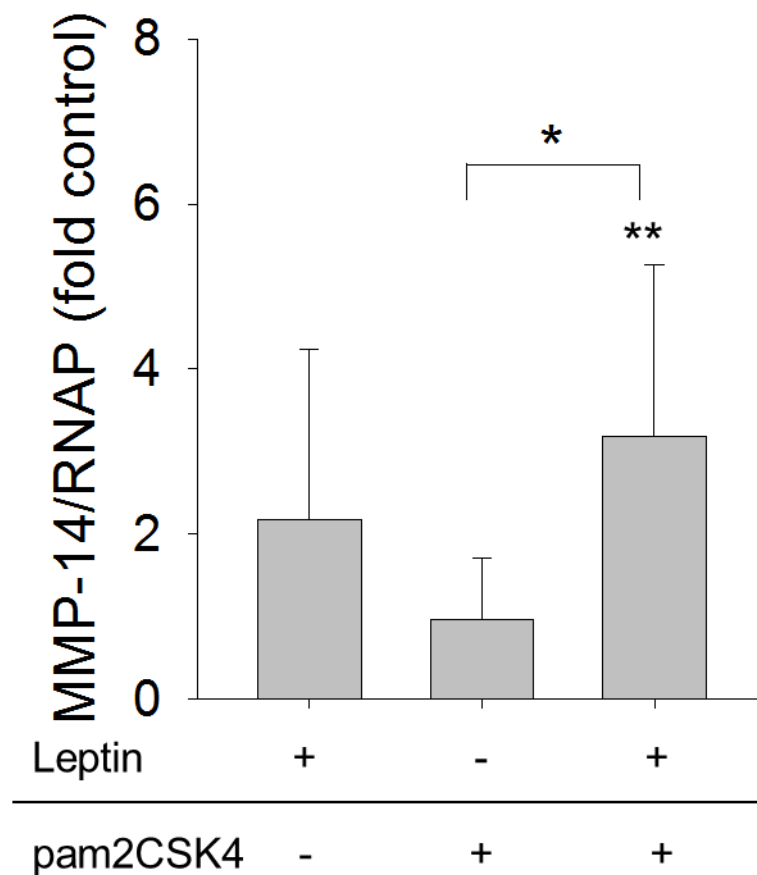

Figure 4.10: MMP-14 gene expression in hGFs after stimulation with leptin and pam2CSK4.

hGFs were stimulated with leptin (10 $\mu\text{g/ml}$), pam2CSK4 (50 ng/ml) or leptin+pam2CSK4 (leptin 10 $\mu\text{g/ml}$, pam2CSK4 50 ng/ml) for 24 h. Cells were lysed and cDNA was prepared by reverse transcription. Real-time RT-PCR was used to assess MMP-14 and RNAP gene expression. Relative MMP-14 gene expression was determined using the $2^{-\text{ddCt}}$ method by using RNAP as the reference gene. Data are shown as mean+SD (n=12) from three donors stimulated in independent experiments. Statistics: T tests for independent samples (Bonferroni-corrected) *=p<0.05, **=p<0.01 as indicated.

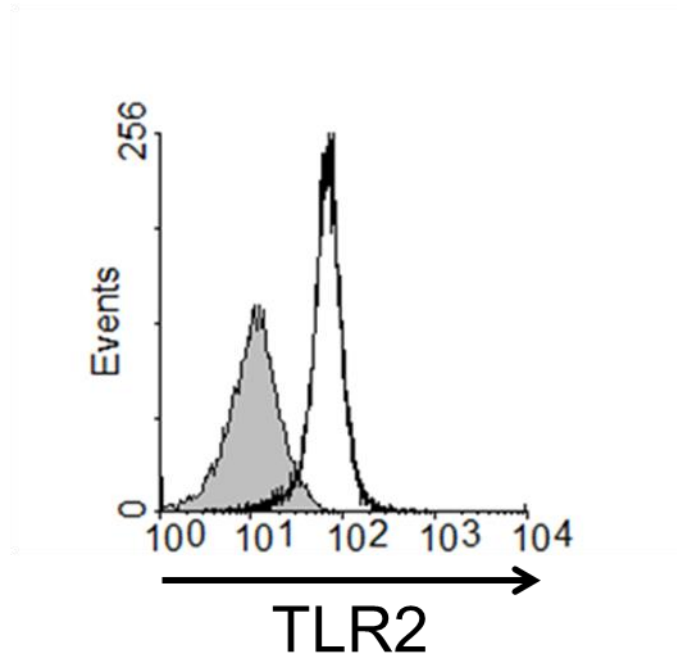

Figure 4.11: TLR2 surface expression on hGFs.

Unstimulated hGFs were prepared and analysed for cell surface TLR2 expression by flow cytometry. Cells were stained with mouse anti-human TLR2 APC-conjugated monoclonal antibody or isotype control antibody. 10000 gated events were acquired using a FACSCalibur flow cytometer. This histogram displays the events for TLR2 staining (no fill) compared to an isotype control (grey fill) and is representative of results from 4 different hGF donors.

Table 4.7: MMP-1 production in hGFs after stimulation with leptin and *E. coli* LPS.

hGFs were stimulated with leptin (10 µg/ml), *E. coli* LPS (10 ng/ml) or leptin+*E. coli* LPS (leptin 10 µg/ml, *E. coli* LPS 10 ng/ml) for 24 h. [A] Cells were lysed and cDNA was prepared by reverse transcription. Real-time RT-PCR was used to assess MMP-1 and RNAP gene expression. Relative MMP-1 gene expression was determined using the $2^{-\Delta\Delta C_t}$ method by using RNAP as the reference gene. Data (fold unstimulated control) are shown as mean±SD (n=4) for each donor. [B] Supernatants were collected and analysed for MMP-1 by ELISA. Data (fold unstimulated control) are shown as mean±SD (n=4) for each donor. Statistics: T tests for independent samples (Bonferroni-corrected) *= $p < 0.05$, **= $p < 0.01$, ***= $p < 0.001$ compared to unstimulated control; #= $p < 0.05$, ##= $p < 0.01$ compared to leptin-stimulated hGFs; §= $p < 0.05$ §§= $p < 0.01$ compared to LPS-stimulated hGFs.

[A] Gene expression (fold control)

	Leptin	LPS	Leptin+ LPS
Donor 2	10.4 ± 2.4*	1.24 ± 0.24	13.7 ± 10.6
Donor 3	9.78 ± 2.8*	7.12 ± 4.72	41.1 ± 13.4 ^{#§}
Donor 4	8.76 ± 2.1**	1.30 ± 0.49	8.41 ± 2.7

[B] Protein (fold control)

	Leptin	LPS	Leptin+ LPS
Donor 2	4.72 ± 0.56***	0.94 ± 0.12	4.53 ± 0.86
Donor 3	5.22 ± 1.57**	4.79 ± 2.06**	11.9 ± 2.1 ^{##§§}
Donor 4	8.45 ± 1.08***	1.07 ± 0.24	8.78 ± 0.90

Table 4.8: MMP-3 protein secretion by hGFs after stimulation with leptin and *E. coli* LPS.

hGFs were stimulated with leptin (10 µg/ml), *E. coli* LPS (10 ng/ml) or leptin+*E. coli* LPS (leptin 10 µg/ml, *E. coli* LPS 10 ng/ml) for 24 h. Supernatants were collected and analysed for MMP-3 by ELISA. Data (ng/ml) are shown as mean±SD (n=4) for each donor. ND – not detected. Statistics: T tests for independent samples (Bonferroni-corrected) **=p<0.01 compared to unstimulated control; ##=p<0.01 compared to leptin-stimulated hGFs; §§=p<0.05 compared to LPS-stimulated hGFs.

	Unstimulated control	Leptin	LPS	Leptin+ LPS
Donor 2	ND	0.44 ± 0.06	ND	0.40 ± 0.02
Donor 3	0.43 ± 0.07	1.76 ± 0.51**	1.88 ± 0.42**	2.94 ± 0.31##§§
Donor 4	ND	ND	ND	ND

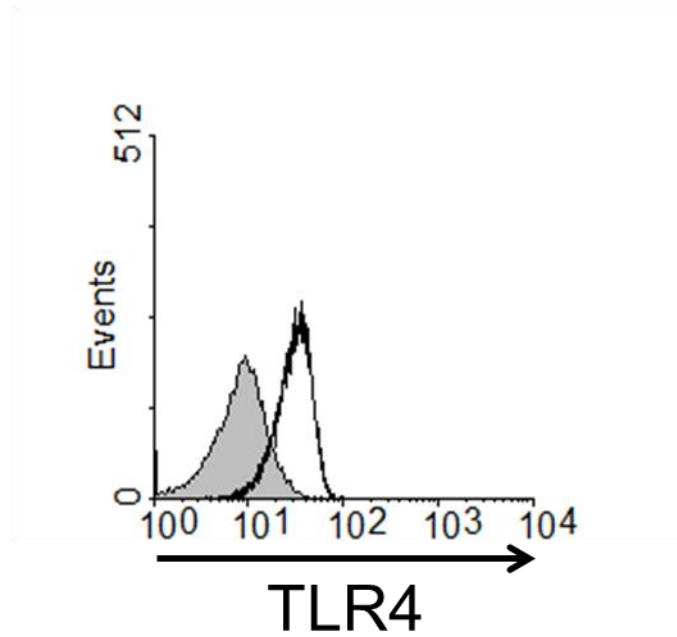

Figure 4.12: TLR4 surface expression on hGFs.

Unstimulated hGFs were prepared and analysed for cell surface TLR4 expression by flow cytometry. Cells were stained with mouse anti-human TLR4 APC-conjugated monoclonal antibody or isotype control antibody. 10000 gated events were acquired using a FACSCalibur flow cytometer. This histogram displays the events for TLR4 staining (no fill) compared to an isotype control (grey fill) and is representative of results from 4 different hGF donors.

5 Chapter 5. Investigation of intracellular signalling pathways which regulate MMP-1 expression in leptin-stimulated hGFs

5.1 Introduction

MMP production is regulated at multiple levels in an effort to ensure that ECM remodelling only occurs when necessary (Section 1.10). MMP-1 is highly regulated at the level of gene transcription and the MMP-1 promoter has binding sites for numerous transcription factors (e.g. NF- κ B, STATs, AP-1, Ets, C/EBP) (Fanjul-Fernandez *et al.*, 2010). These transcription factors are upregulated and/or activated downstream of intracellular signalling cascades. Several signalling pathways are implicated in promoting growth factor and cytokine-stimulated MMP-1 expression, including the NF- κ B, MAPK and JAK/STAT pathways (Vincenti, 2001).

Many studies have shown that cytokines (e.g. IL-1, TNF- α , OSM) enhance MMP-1 production via the MAPK signalling pathway in fibroblasts and chondrocytes (Barchowsky *et al.*, 2000; Mengshol *et al.*, 2000; Han *et al.*, 2001; Cortez *et al.*, 2007; O'Kane *et al.*, 2010). However, the particular MAPK signalling intermediates thus identified vary between studies. ERK and p38 MAPK activity are required for MMP-1 production in cytokine-stimulated synovial fibroblasts, chondrocytes and cardiac fibroblasts (Barchowsky *et al.*, 2000; Mengshol *et al.*, 2000; Cortez *et al.*, 2007). JNK (and ERK) MAPK activity is required for enhancing cytokine-stimulated MMP-1 production in synovial fibroblasts isolated from individuals with RA (Han *et al.*, 2001; Tagoe *et al.*, 2008). This could suggest that different signalling pathway intermediates regulate MMP-1 production in synovial fibroblasts during RA; however, a pharmacological inhibitor of JNK has only relatively recently been available (Bennett *et al.*, 2001). Therefore, earlier studies investigating MAPK signalling often only investigated the ERK and p38 arms of the MAPK signalling pathway; JNK activity was not explored (Barchowsky *et al.*, 2000; Mengshol *et al.*, 2000). Fibroblasts isolated from different sites require different MAPK intermediates to regulate MMP-1 production (Han *et al.*, 2001; O'Kane *et al.*, 2010). For example, synovial fibroblasts require JNK and ERK, but not p38, to regulate cytokine-stimulated MMP-1 production (Han *et al.*, 2001); in contrast, p38, but not ERK or JNK, is required to regulate MMP-1 production by lung fibroblasts under inflammatory conditions (O'Kane *et al.*, 2010). This suggests that the regulation of MMP-1 expression is not necessarily translatable

between different fibroblast populations, and supports investigations into the signalling pathway intermediates that regulate MMP-1 in distinct fibroblast populations.

The MAPK signalling pathway is not the only pathway that regulates MMP-1 production. Cytokine-stimulated MMP-1 expression in human RA synovial fibroblasts and cardiac fibroblasts requires NF- κ B activity (Cortez *et al.*, 2007; Tagoe *et al.*, 2008). However, cytokine-stimulated MMP-1 production in rabbit synovial fibroblasts is not dependent on NF- κ B, even though NF- κ B is activated (Barchowsky *et al.*, 2000). This suggests that the signalling pathways that regulate MMP-1 expression vary between species, and supports investigations into the signalling pathway intermediates that regulate MMP-1 in human cell populations. STAT3 activity regulates MMP-1 production in EGF-stimulated bladder epithelial cells (Itoh *et al.*, 2006), and OSM-stimulated chondrocytes (Catterall *et al.*, 2001). Furthermore, Itoh *et al.* (2006) found that only STAT3 and not STAT1 or STAT5 regulated EGF-stimulated MMP-1 production in bladder epithelial cells, suggesting that specific members of the STAT transcription factor family regulate MMP-1 production. OSM activates the PI3K/Akt signalling pathway and MMP-1 expression in chondrocytes (Litherland *et al.*, 2008); however PI3K/Akt activity only regulates the synergistic increases in MMP-1 expression when chondrocytes are stimulated with OSM in combination with IL-1. This suggests that during the presence of multiple stimuli additional signalling pathways may play a role in regulating MMP-1 expression. This supports investigations into the signalling pathway intermediates that regulate MMP-1 during exposure to single stimuli and combinations of stimuli.

Leptin activates multiple intracellular signalling pathways, including the JAK/STAT and MAPK pathways (Section 1.2), which suggests that leptin signalling could regulate MMP production. Indeed, several studies have found that leptin regulates MMP production (Section 1.4.3). MAPK, NF- κ B and PKC signalling are required for leptin-mediated MMP-1 production by human osteoarthritis cartilage (Koskinen *et al.*, 2011). Similarly, MAPK (p38 and ERK) and PI3K/Akt signalling are required for leptin-mediated MMP-1 gene expression in primary human chondrocytes (Hui *et al.*, 2012). The same mediators are required to regulate MMP-1 expression in chondrocytes synergistically stimulated by leptin+IL-1, suggesting that leptin and IL-1 synergistically regulate MMP-1 expression by amplifying the activity of the same intracellular signalling pathways. In contrast, the MAPK ERK and JAK2 (which is upstream of STAT transcription factor activation) are required to regulate leptin-mediated decreases

in MMP-1 production by HSCs (Cao *et al.*, 2007). Together, these studies demonstrate that several signalling pathway intermediates regulate leptin stimulated-MMP-1 production, and that the intermediates required vary between cell types. This supports investigations into the signalling pathway intermediates that determine leptin-regulated MMP-1 expression in different cell types.

Gingival fibroblasts can be stimulated to increase the production of MMPs (Section 1.11.1), however relatively few studies have investigated which intracellular signalling pathway intermediates regulate this response. Pro-inflammatory cytokines and platelet-derived growth factor increase MMP-1 expression in gingival fibroblasts in a MAPK-dependent manner (Domeij *et al.*, 2002; Kida *et al.*, 2005; Ujii *et al.*, 2012). In all of these studies p38 MAPK was required to regulate MMP-1 expression. Only Kida *et al.* (2005) investigated the role of other MAPKs in regulating MMP-1 production in gingival fibroblasts, and found that ERK and JNK are also required. Additionally, Kida *et al.* (2005) found that NF- κ B signalling regulates MMP-1 expression in IL-1-stimulated gingival fibroblasts.

No studies to date have investigated intracellular signalling pathway activation in leptin-stimulated gingival fibroblasts, and whether these signalling events are involved in the regulation of MMP expression. Gingival fibroblasts express all four of the human leptin receptor isoforms at the mRNA level (Park *et al.*, 2013). Additionally, leptin receptor protein is present at low levels in buccal connective tissue (Umeki *et al.*, 2014). These studies suggest that gingival fibroblasts have the potential to respond to leptin directly.

The results presented thus far in this study suggest that leptin, alone or synergistically with IL-1 or pam2CSK4, increases MMP-1 mRNA levels and secretion (Chapters 3 and 4). Therefore, the aim of the experiments presented in this chapter was to investigate which signalling pathways are involved in leptin-mediated MMP expression in hGFs.

5.2 Leptin receptor expression by gingival fibroblasts

hGFs were lysed either under basal conditions or after stimulation with leptin (0.1 or 10 μ g/ml) for 24 h. cDNA was prepared from the cell lysates and semi-quantitative RT-PCR was used to determine whether hGFs expressed the long isoform of the leptin receptor (Figure 5.1). The long isoform of the leptin receptor was expressed in all donors tested (n=7).

hGFs were prepared and analysed for cell surface leptin receptor expression by flow cytometry (Section 2.2.7) (Figure 5.2). hGFs isolated from all donors tested expressed leptin receptor on the cell surface (n=4). Across the donors tested, the MFI increased 2.2 ± 0.2 -fold in samples stained for leptin receptor compared to the isotype control.

5.3 Activation of intracellular signalling pathways in gingival fibroblasts stimulated with leptin, IL-1, OSM and pam2CSK4

The pathways investigated in this study were chosen because they are activated by leptin and can regulate MMP expression (Sections 1.2 and 1.10). hGFs were stimulated with leptin (10 μ g/ml), IL-1 (0.05 ng/ml), leptin+IL-1 (leptin 10 μ g/ml, IL-1 0.05 ng/ml), pam2CSK4 (50 ng/ml), leptin+pam2CSK4 (leptin 10 μ g/ml, pam2CSK4 50 ng/ml) or OSM (5 ng/ml) for 20 min. Cell lysates were prepared for SDS-PAGE. Selected intracellular signalling pathway intermediates were assessed by Western blot (Section 2.11.3). A 20 min time point was chosen as phosphorylation of MAPK, JAK/STAT and PI3K signalling pathway intermediates is detected at this time point after leptin and IL-1 stimulation of chondrocytes (Hui *et al.*, 2012). Additionally, in a preliminary time course experiment leptin enhanced STAT3 and ERK (p42/44) phosphorylation at 10 and 30 min time points (albeit at very low levels) (Figure G.1). Unstimulated hGFs served as a negative control. OSM-stimulated hGFs were used to identify the signalling pathways activated by an IL-6-family cytokine, and were compared to the responses generated by leptin.

5.3.1 Leptin activation of the MAPK signalling pathway in hGFs

Leptin increased the phosphorylation of the MAPKs p38, ERK (p42/44) and JNK in hGFs isolated from all three donors compared to the unstimulated control (Figure 5.3). Increased levels of p38, ERK (p42/44) and JNK phosphorylation were also observed in hGFs stimulated with leptin+IL-1 or leptin+pam2CSK4 compared to the unstimulated control (Figure 5.3). The levels of p38 and ERK (p42/44) phosphorylation were higher in hGFs stimulated with leptin+IL-1 compared to those stimulated with leptin or IL-1 alone (in donors 4 and 7); a similar effect was observed for JNK phosphorylation (in donors 4 and 6) (Figure 5.3). This suggests that the phosphorylation of p38, ERK (p42/44) and JNK in hGFs is increased synergistically by leptin and IL-1. In hGFs isolated from two of the three donors (donors 6 and 7) the levels of p38 and JNK phosphorylation were higher after leptin+pam2CSK4 stimulation compared to those cells stimulated with leptin or pam2CSK4 alone, which suggests that the phosphorylation of p38 and JNK is synergistically increased by leptin and pam2CSK4.

No synergistic increases in ERK (p42/44) phosphorylation were detected after leptin+pam2CSK4 stimulation. OSM-stimulated hGFs had slightly increased levels of ERK (p42/44) phosphorylation compared to the unstimulated control but had little phosphorylated p38 or JNK at the 20 m time point.

Higher levels of p42 ERK were evident in hGFs in donors 6 and 7 across multiple treatment conditions (including unstimulated cells) compared to p44 ERK (Figure 5.3). In leptin or leptin+IL-1-stimulated hGFs from donor 7 higher levels of the 46 kDa JNK isoform were phosphorylated in comparison to the 54 kDa JNK isoform (Figure 5.3). In contrast, in leptin+pam2CSK4-stimulated hGFs from the same donor equal levels of phosphorylation between the JNK isoforms (46 and 54 kDa) were observed. Different JNK isoforms could not be distinguished in hGFs from the other donors; it is unclear whether the bands on these blots represent one JNK isoform or both JNK isoforms co-localised because of poor blot resolution.

5.3.2 Leptin activation of the JAK/STAT signalling pathway in hGFs

Leptin or OSM stimulation increased the tyrosine phosphorylation of STAT1 and STAT3 in hGFs isolated from all three donors compared to the unstimulated control (Figure 5.4). Increased levels of STAT1 and STAT3 tyrosine phosphorylation were also observed in hGFs stimulated with leptin+IL-1 or leptin+pam2CSK4 compared to the unstimulated control. The levels of STAT3 tyrosine phosphorylation were higher in hGFs stimulated with leptin+IL-1 compared to those stimulated with leptin or IL-1 alone in two of the three donors tested (donors 6 and 7); no similar effect was observed for STAT1 tyrosine phosphorylation (across all donors) (Figure 5.4). The levels of STAT3 tyrosine phosphorylation were higher in hGFs stimulated with leptin+pam2CSK4 compared to those stimulated with leptin or pam2CSK4 alone (also in donors 6 and 7). Together, this suggests that STAT3 tyrosine phosphorylation is synergistically increased by leptin and IL-1 or pam2CSK4 in hGFs. In hGFs isolated from donor 7 higher levels of STAT1 tyrosine phosphorylation were detected after leptin+pam2CSK4 stimulation compared to hGFs stimulated with leptin or pam2CSK4 alone; however, GAPDH levels were also higher in leptin+pam2CSK4-stimulated hGFs compared to hGFs stimulated with leptin or pam2CSK4 alone in this donor (Figure 5.4), suggesting that this effect could have been due to unequal protein levels between the samples.

Serine-phosphorylated STAT3 was not detected across any treatment conditions in hGFs isolated from two of the three donors tested (donors 4 and 7). In hGFs isolated from donor 6 the levels of STAT3 serine phosphorylation detected were low, but were increased in hGFs stimulated with leptin+IL-1, pam2CSK4 or leptin+pam2CSK4 compared to the unstimulated control (Figure 5.4). Native STAT3 protein levels were consistent across treatment conditions in hGFs (only assessed in donor 4). Leptin had no effect on STAT1 serine phosphorylation in hGFs (across all donors) compared to the unstimulated control; the levels of serine-phosphorylated STAT1 between the other treatment conditions and the unstimulated control were variable between donors (Figure 5.4).

In leptin (\pm IL-1 or pam2CSK4)-stimulated hGFs from donors 6 and 7 higher levels of the 91 kDa STAT1 α isoform were tyrosine phosphorylated in comparison to the 84 kDa STAT1 β isoform (Figure 5.4).

5.3.3 Leptin activation of the PI3K signalling pathway

Leptin, leptin+IL-1, leptin+pam2CSK4 or OSM stimulation increased the serine phosphorylation of Akt in hGFs isolated from all three donors compared to the unstimulated control (Figure 5.5). Increased levels of threonine-phosphorylated Akt were detected after leptin, leptin+IL-1, leptin+pam2CSK4 or OSM stimulation in one of the two donors tested (donor 4). Additionally, the levels of threonine-phosphorylated Akt in hGFs isolated from donor 4 were higher after leptin+pam2CSK4 stimulation compared to cells stimulated with leptin or pam2CSK4 alone (Figure 5.5). In contrast, no threonine-phosphorylated Akt was detected in the other donor assessed (donor 6) across all treatment conditions.

In one donor (donor 6), the levels of Akt serine phosphorylation were higher in leptin+IL-1-stimulated hGFs compared to hGFs stimulated with leptin or IL-1 alone; however, this was not observed in hGFs isolated from the other donors (Figure 5.5). In two of the three donors (donors 6 and 7) leptin+pam2CSK4-stimulated hGFs had higher levels of Akt serine phosphorylation compared to hGFs stimulated with leptin or pam2CSK4 alone, which suggests that serine phosphorylation of Akt is increased synergistically by leptin and pam2CSK4.

5.3.4 Leptin activation of the NF- κ B signalling pathway

Leptin and OSM did not increase the levels of serine-phosphorylated NF- κ B p65 in hGFs compared to the unstimulated control in the one donor tested (Figure 5.6). In

contrast, the levels of serine-phosphorylated NF- κ B p65 were higher in hGFs stimulated with IL-1 or pam2CSK4 (with or without leptin) compared to the unstimulated control.

5.4 Signalling pathway intermediates which regulate MMP-1 expression in leptin-stimulated gingival fibroblasts

The signalling pathways chosen to be inhibited were selected based on whether they were activated by leptin, IL-1 or pam2CSK4 in Section 5.3. hGFs were pre-treated for 30 min with chemical pathway inhibitors; a full description of the inhibitors and the concentrations used is presented in Table 5.1. An additional pre-treatment condition, 0.1 % v/v DMSO, was used to control for non-specific effects as the inhibitors were dissolved in DMSO. After pre-treatment, hGFs were stimulated with leptin (10 μ g/ml), IL-1 (0.05 ng/ml), leptin+IL-1 (leptin 10 μ g/ml, IL-1 0.05 ng/ml), pam2CSK4 (50 ng/ml) or leptin+pam2CSK4 (leptin 10 μ g/ml, pam2CSK4 50 ng/ml) for 24 h. hGFs were lysed and cDNA prepared by reverse transcription. Real-time RT-PCR was used to assess how the relative levels of MMP-1 gene expression in stimulated hGFs were affected by inhibiting specific signalling pathway intermediates.

In a preliminary experiment, hGFs were pre-treated for 30 m with either 0.1 % v/v DMSO or serum-free DMEM (SFM) prior to stimulation as above. Real-time RT-PCR was used to assess whether the relative levels of MMP-1 gene expression in stimulated hGFs were affected by 0.1 % v/v DMSO. DMSO pre-treatment (0.1 % v/v) had no significant effect on MMP-1 gene expression for any of the stimulatory conditions tested (Appendix H).

Bay 11-7085 at a concentration of 10 μ M did not cause any toxicity in hGFs as described in the methods (Section 2.2.6.1). However, hGFs from all the subsequent donors treated with 10 μ M Bay 11-7085 were subject to extensive toxicity as evidenced by loss of attachment and shrinkage upon visual inspection at the 24 h end point of the stimulation. Therefore, MMP-1 gene expression was not assessed in these samples.

5.4.1 MEK/ERK regulate leptin-stimulated MMP-1 gene expression in hGFs

Inhibition of MEK/ERK signalling in leptin-stimulated hGFs caused a 3.0-fold decrease ($p < 0.01$) in MMP-1 gene expression (Figure 5.7). Similarly, 5.4-fold and 3.2-fold decreases in MMP-1 gene expression in IL-1 and leptin+IL-1-stimulated hGFs respectively were observed after MEK/ERK inhibition (both $p < 0.001$). Additionally, inhibition of MEK/ERK signalling in pam2CSK4 and leptin+pam2CSK4-stimulated

hGFs caused 2.5-fold and 3.8-fold decreases respectively in MMP-1 gene expression (pam2CSK4 $p < 0.05$, leptin+pam2CSK4 $p < 0.001$).

5.4.2 JNK regulation of MMP-1 gene expression in hGFs

JNK inhibition did not significantly alter MMP-1 gene expression in hGFs stimulated with leptin or pam2CSK4 (Figure 5.8). However, MMP-1 gene expression was reduced 2.3-fold after JNK inhibition in hGFs stimulated with leptin+pam2CSK4 ($p < 0.05$). Interestingly, inhibition of JNK reduced MMP-1 gene expression 2.3-fold and 36 % in hGFs stimulated with IL-1 and leptin+IL-1 respectively (both $p < 0.01$).

5.4.3 p38 regulation of MMP-1 gene expression in hGFs

Inhibition of p38 signalling did not significantly alter MMP-1 gene expression in hGFs stimulated with leptin, IL-1, pam2CSK4 or leptin+pam2CSK4 (Figure 5.9). In contrast, MMP-1 gene expression was reduced 2.3-fold in hGFs stimulated with leptin+IL-1 after inhibition of p38 signalling.

5.4.4 STAT3 regulation of MMP-1 gene expression in hGFs

STAT3 inhibition did not significantly alter MMP-1 gene expression in hGFs stimulated with leptin or pam2CSK4 (Figure 5.10). However, MMP-1 gene expression was reduced 2.3-fold after STAT3 inhibition in hGFs stimulated with leptin+pam2CSK4 ($p < 0.05$). Inhibition of STAT3 signalling reduced MMP-1 gene expression 2.3-fold and 39 % in hGFs stimulated with IL-1 and leptin+IL-1 respectively (both $p < 0.05$).

5.4.5 AKT regulation of MMP-1 gene expression in hGFs

AKT inhibition did not significantly alter MMP-1 gene expression in hGFs under any of the treatment conditions tested (Figure 5.11).

5.5 Discussion

The increased production of the collagenase MMP-1 under inflammatory conditions is implicated in deleterious collagen and ECM remodelling, as occurs in osteoarthritis, rheumatoid arthritis (RA) and periodontitis (Burrage *et al.*, 2006; Sorsa *et al.*, 2006). Leptin (alone and in synergy with pro-inflammatory mediators) increases MMP-1 production in chondrocytes and cartilage (Koskinen *et al.*, 2011; Hui *et al.*, 2012), and in gingival fibroblasts in this study (Chapters 3 and 4). Multiple signalling pathway intermediates are implicated in regulating MMP-1 gene expression (Section 1.10), but the individual signalling mediators that are involved vary depending on cell type and input stimuli. No studies of leptin-stimulated intracellular signalling in gingival

fibroblasts have been previously reported; therefore it was unknown how leptin signalling might affect MMP-1 expression in gingival fibroblasts. The results presented in this chapter show that leptin activates the MAPK, JAK/STAT, and PI3K signalling pathways in gingival fibroblasts. Additionally, the MAPK and JAK/STAT signalling pathways were found to be required for increasing MMP-1 gene expression in gingival fibroblasts after stimulation with leptin, IL-1 and/or pam2CSK4.

The long leptin receptor isoform is expressed by gingival fibroblasts as demonstrated by Park *et al.* (2013), and in this study. Cell surface expression of the leptin receptor has been detected in human cells previously (Zarkesh-Esfahani *et al.*, 2004), and in gingival fibroblasts for the first time in this study. One of the limitations of measuring cell surface leptin receptor by flow cytometry is that the extracellular region of the leptin receptor is the same for the different isoforms, and therefore it is unclear which of the isoforms are present on the cell surface. All the short isoforms of the leptin receptor are expressed at the mRNA level by gingival fibroblasts (Park *et al.*, 2013), so it is likely that the detected leptin receptor on the surface on gingival fibroblasts consists of multiple leptin receptor isoforms. This could affect the degree of intracellular signalling stimulated by leptin, because only the long isoform leptin receptor can facilitate the activation of all the intracellular signalling pathways that leptin stimulates (Bjorbaek *et al.*, 1997).

In this study enhanced STAT3 Y705, STAT1 Y701, MAPK (ERK, JNK, p38) and Akt phosphorylation was detected in gingival fibroblasts after leptin stimulation for the first time; these are some of the well characterised signalling responses activated downstream of the long leptin receptor isoform (Coppari and Bjorbaek, 2012).

Together, these data suggest that functional long leptin receptor isoform is present on the surface of fibroblasts within the gingiva, and that one of the functions of gingival fibroblasts is to directly sense local leptin concentrations. Further experiments that aim to specifically block leptin/leptin receptor interaction are required to confirm this. In the current study several experiments using a leptin antagonist (ProSpec, Ness-Ziona, Israel) were performed. The leptin antagonist is recombinant leptin but with three mutations (L39A, D40A, F41A) that competitively binds to the leptin receptor, but does not activate STAT3 signalling (Shpilman *et al.*, 2011). The leptin antagonist had no ability to reduce MMP-1 production (protein) or STAT3 tyrosine phosphorylation by

hGFs stimulated with leptin, possibly due to the use of an ineffective leptin:antagonist ratio (Appendix I).

Leptin failed to increase NF- κ B p65 phosphorylation in gingival fibroblasts, although this conclusion should be viewed with caution as hGFs from only one donor were tested. This result, however, contradicts a previous study investigating leptin signalling in synovial fibroblasts from individuals with RA (Tong *et al.*, 2008). Tong *et al.* (2008) investigated leptin signalling at a similar time point and using a similar concentration of leptin to this study, suggesting that this discrepancy is due to the different cell types tested or disease status of the cells. Further studies of NF- κ B signalling in hGFs isolated from more donors are required to confirm this.

STAT1 and STAT3 tyrosine phosphorylation is a feature of leptin receptor and OSM receptor signalling (e.g. type I cytokine receptor signalling) (Fantuzzi and Faggioni, 2000). STAT1 and STAT3 tyrosine phosphorylation was observed in this study in gingival fibroblasts after stimulation with OSM or leptin, but not IL-1 or pam2CSK4. This provides some support to the theory that leptin and OSM do not synergise to regulate MMP production because they activate similar signalling pathways (Section 4.4).

Differences in the relative abundance and phosphorylation of ERK MAPK isoforms have been described previously (Pages and Pouyssegur, 2004), and were observed in this study. Interestingly, ERK2 (p42) knockout mice are embryonic lethal while ERK1 (p44) knockout mice are viable (Yao *et al.*, 2003), which suggests that the ERK isoforms have different functions. Furthermore, ERK2 promotes the proliferative responses of mouse embryonic fibroblasts (Vantaggiato *et al.*, 2006), while ERK1 acts as an inhibitor of ERK2 presumably by competing for MEK (the kinase directly upstream of and responsible for phosphorylating ERK) (Mazzucchelli *et al.*, 2002; Vantaggiato *et al.*, 2006). Together with the higher levels of total and phosphorylated ERK2 compared to ERK1 in gingival fibroblasts observed in this study, this suggests that ERK2-mediated responses may predominate over ERK1 responses in gingival fibroblasts. The inhibitor used in this study, U0126 inhibits MEK, and therefore inhibits both ERK isoforms; future investigations using siRNA to target ERK2 and ERK1 individually may help to delineate the functional importance of the different ERK isoforms in gingival fibroblasts.

An increase in the relative abundance of p46 compared to the p54 molecular weight form of phosphorylated JNK MAPK was observed in this study. Differences in the downstream targets of p46 JNK and p54 JNK have been described previously (Liu *et al.*, 2004; Singh *et al.*, 2009); for example, p46 JNK (but not p54 JNK) is essential for phosphorylating the transcription factors c-Jun and ATF-2 in mouse fibroblasts (Liu *et al.*, 2004). Together, this suggests that there is more p46 JNK activity than p54 JNK activity in leptin-stimulated hGFs, and that this might be affecting the phosphorylation of downstream transcription factors. However, there are three JNK genes in humans and 10 different JNK isoforms due to differential mRNA splicing; all of these isoforms have a molecular weight of approximately 46 or 54 kDa (Bennett *et al.*, 2001). It would be interesting to determine by RT-PCR which of the JNK isoforms are expressed in (leptin-stimulated) gingival fibroblasts as a first step in attempting to understand whether the different JNK isoforms are responsible for different gingival fibroblast responses.

STAT1 has two isoforms which are generated by alternative splicing: STAT1 α (91 kDa) and STAT1 β (84 kDa) (Darnell, 1997). Both STAT1 isoforms were tyrosine phosphorylated in leptin-stimulated gingival fibroblasts in this study, and there was a greater relative abundance of pSTAT1 α Y701 compared to pSTAT1 β Y701. STAT1 α and STAT1 β regulate different transcriptional responses, thought to be partly due to the lack of a transactivation domain (which is a binding site for transcriptional activators) in STAT1 β that is present in STAT1 α (Darnell, 1997; Najjar *et al.*, 2008). This suggests that STAT1 α activity may predominate over STAT1 β activity in leptin-stimulated gingival fibroblasts. Plasmid-mediated overexpression of STAT1 isoforms has been used previously to determine the differential roles of STAT1 α and STAT1 β in B cells (Najjar *et al.*, 2008), and may be a technique amenable to further investigation of the relative functions of STAT1 isoforms in hGFs.

The MAPK signalling pathway is activated by leptin, and is required to regulate MMP-1 production in chondrocytes and cartilage (Koskinen *et al.*, 2011; Hui *et al.*, 2012), and in gingival fibroblasts in this study. The MAPK signalling pathway regulates MMP production in several ways (Burrage *et al.*, 2006). ERK and JNK MAPK phosphorylate components of the dimeric transcription factor AP-1 (e.g. c-Fos and c-Jun), thereby activating AP-1 and promoting AP-1 binding to DNA (Mengshol *et al.*, 2002). The promoter region for MMP-1 contains several binding sites for AP-1; AP-1 is considered a key transcription factor for MMP-1 gene expression (Burrage *et al.*, 2006).

Additionally, ERK and JNK-activated c-Jun can bind to the c-Jun and c-Fos promoters, thereby increasing the levels of AP-1 protein and promoting MMP gene expression in an indirect manner (Burrage *et al.*, 2006). ERK and p38 MAPK are also implicated in activating the transcription factor Ets which can directly enhance MMP-1 gene expression by binding to PEA-1 sites on the MMP-1 promoter (Burrage *et al.*, 2006). Therefore, MAPK signalling can regulate MMP-1 gene expression by directly activating transcription factors that bind to the MMP-1 promoter, or by indirectly upregulating the transcription of genes like c-Fos and c-Jun that make up transcription factors that regulate MMP-1 expression.

In this study, leptin and pam2CSK4 required ERK MAPK signalling to increase MMP-1 gene expression in hGFs. A similar requirement for ERK in regulating MMP-1 expression was observed in a study of leptin-stimulated chondrocytes (Hui *et al.*, 2012). However, Hui *et al.* (2012) also found that p38 and JNK regulated leptin-stimulated MMP-1 gene expression in chondrocytes; no significant requirement for these MAPK mediators was observed regarding leptin (or pam2CSK4)-stimulated MMP-1 expression in gingival fibroblasts in this study. This discrepancy may be due to the different cell types studied.

IL-1-stimulated gingival fibroblasts require MAPK signalling to regulate MMP-1 production as observed in this and other studies (Domeij *et al.*, 2002; Kida *et al.*, 2005). In the present study ERK and JNK, but not p38, were required to regulate IL-1-stimulated MMP-1 gene expression; however, Kida *et al.* (2005) found that all three of these MAPK mediators were required to regulate MMP-1 secretion in IL-1-stimulated gingival fibroblasts. The activation of MAPK signalling is regulated by the strength of the stimuli (Raman *et al.*, 2007). The discrepancy between this study and that of Kida *et al.* (2005) could be due to a dose-dependent effect of IL-1 (in this study 0.05 ng/ml IL-1 was used, while Kida *et al.* (2005) used a higher concentration of 2.5 ng/ml). Additionally, Domeij *et al.* (2002) found that p38 was required for IL-1-stimulated MMP-1 secretion by gingival fibroblasts. Both Domeij *et al.* (2002) and Kida *et al.* (2005) investigated MMP-1 secretion, not gene expression, which suggests that p38 may regulate MMP-1 production at a level downstream of gene transcription and RNA stability in gingival fibroblasts.

Taken together, these results suggest that ERK regulates non-synergistic increases in MMP-1 gene expression in leptin and pam2CSK4-stimulated gingival fibroblasts, while

ERK and JNK regulate IL-1-stimulated MMP-1 expression. Mechanistically, MMP-1 expression in leptin, IL-1 and pam2CSK4-stimulated hGFs could be enhanced by ERK/JNK dependent increases in the activity and protein levels of the transcription factor AP-1, and by ERK-dependent increases in the activity of the transcription factor Ets.

MAPK intermediates partially regulated MMP-1 gene expression in hGFs after stimulation with leptin+IL-1 (ERK, JNK and p38), or leptin+pam2CSK (ERK and JNK). This suggests that multiple arms of the MAPK signalling pathway are required to generate the levels of MMP-1 gene expression observed during the synergy between these stimuli. Therefore, it is likely that a broad amplification and activation of the MAPK signalling pathway is one mechanism by which leptin and IL-1 or pam2CSK4 synergistically regulate MMP-1 expression. For example, similar to ERK and JNK, p38 can increase the expression of c-Fos and c-Jun, thereby increasing AP-1 protein levels and potentially enhancing MMP-1 expression (Vincenti and Brinckerhoff, 2002) (as discussed above). Thus, the synergistic upregulation of MMP-1 expression in hGFs by leptin+IL-1 could be mediated by an additional increase in c-Jun and c-Fos expression due to p38 activity.

In this study MMP-1 expression in hGFs after stimulation with IL-1±leptin or leptin+pam2CSK4 required STAT3 signalling. This suggests that the MAPK signalling pathway is not the only intracellular signalling cascade required for MMP-1 expression in hGFs. However, STAT3 may only play a role in promoting the higher levels of MMP-1 expression observed in hGFs. The MMP-1 promoter contains a STAT-binding site (Barchowsky *et al.*, 2000; Itoh *et al.*, 2006), and therefore STAT3 may directly regulate MMP-1 expression in hGFs. In IL-1+OSM-stimulated chondrocytes, STAT3 acts in an indirect manner to regulate MMP-1 expression by increasing c-Fos expression (Catterall *et al.*, 2001); the c-Fos promoter also contains a STAT-binding site. As such, STAT3 may indirectly regulate MMP-1 expression in hGFs. Alternatively, given the concomitant activation of the MAPK and JAK/STAT pathway in leptin+IL-1/pam2CSK4-stimulated hGFs, it is possible that cross-talk between the JAK/STAT and MAPK signalling pathways, as characterised previously (Wisler *et al.*, 2011), could also regulate the synergy between leptin+IL-1/pam2CSK4 that increases MMP-1 expression in hGFs. Another possible mechanism by which JAK/STAT signalling may affect MMP expression includes regulating chromatin remodelling to increase promoter availability (Bezbradica and Medzhitov, 2009). For example, in murine T cells IFN- γ production

requires JAK3/STAT5-mediated acetylation of the IFN- γ promoter (Shi *et al.*, 2008). Finally, the importance of STAT activity in regulating MMP expression in gingival fibroblasts may be underestimated in this study due to functional redundancy between STATs (Murray, 2007). For example, when STAT3 was inhibited the functions of STAT3 may have been performed by STAT1, which was similarly tyrosine phosphorylated by leptin in this study.

In gingival fibroblasts in this study and in chondrocytes in a previous study, IL-1 did not increase STAT3 tyrosine phosphorylation (Hui *et al.*, 2012). Therefore, it was somewhat unexpected that IL-1-stimulated hGFs required STAT3 to regulate MMP-1 expression. However, IL-1 can stimulate STAT3 tyrosine phosphorylation in murine osteoblasts (Mori *et al.*, 2011). Perhaps IL-1 similarly stimulates STAT3 tyrosine phosphorylation in hGFs, but at a time point other than the 20 min assessed in this study. Further studies with a more comprehensive range of time points may help to identify how STAT3 (and other STATs) regulate MMP-1 expression in gingival fibroblasts, particularly in the presence of IL-1 and TLR agonists which have been reported to inhibit JAK/STAT signalling previously (Ahmed and Ivashkiv, 2000). STAT3 serine phosphorylation is increased in leptin-stimulated chondrocytes at 60 min (Hui *et al.*, 2012); therefore, a comprehensive time course study may also help elucidate the profile of STAT3 serine phosphorylation in leptin-stimulated gingival fibroblasts which was inconclusive in the present study.

The results showing that Akt had no ability to regulate MMP-1 expression in leptin-stimulated gingival fibroblasts are in agreement with another study in human chondrocytes using the same inhibitor (Hui *et al.*, 2012). A lower concentration of the Akt inhibitor had to be used in this study compared to Hui *et al.* (2012) to prevent toxicity. Therefore, the Akt inhibitor may only have been inhibiting Akt1 and Akt2 (not Akt3) isoforms according to *in vitro* kinase assays as performed by the manufacturer. To investigate whether Akt3 regulates MMP-1 expression in gingival fibroblasts siRNA-mediated knockdown of Akt3 would be required. Nonetheless, these results suggest that Akt1 and Akt2 are not involved in regulating MMP-1 expression in gingival fibroblasts. Intriguingly, these results contradict those in a previous study of chondrocytes, where Akt1 was required to regulate IL-1+OSM-stimulated MMP-1 expression (Litherland *et al.*, 2008). This discrepancy could either be due to the different stimuli tested or could suggest that Akt signalling after pro-inflammatory stimulation is cell-type specific. In support of the latter idea, the 10 μ M concentration of

Akt VIII inhibitor used by Litherland *et al.* (2008) on chondrocytes would have killed the gingival fibroblasts in the present study (Figure A.1B). The ability of hGFs to regulate collagen phagocytosis is Akt-dependent (Takahashi *et al.*, 2008). Therefore, while Akt may not regulate MMP-1 expression, Akt may still be able to regulate collagen degradation by gingival fibroblasts in an alternative way.

It would also be interesting to determine what functional significance, if any, leptin-stimulated Akt phosphorylation has on gingival fibroblast function, beyond regulating hGF proliferation as observed in this study (Figure A.1B). Signalling via the PI3K/Akt pathway is implicated in a number of inflammatory diseases including inflammatory bowel disease (IBD) and RA (Wisler *et al.*, 2011). For example, Akt is one of a number of signalling pathway intermediates that regulates the expression of the chemokine CXCL8 in leptin-stimulated synovial fibroblasts (Tong *et al.*, 2008). No previous studies have investigated the outcomes of leptin-stimulated Akt activity in gingival fibroblasts. Akt signalling regulates the expression of IL-23 (Zhu *et al.*, 2011), TLR2 (Gutiérrez-Venegas and Arreguín-Cano, 2011) and CXCL10 (Hosokawa *et al.*, 2010a) in gingival/periodontal fibroblasts, and therefore, future studies investigating leptin-stimulated Akt activity in hGFs are warranted.

One limitation with the approach used in this study is that chemical pathway inhibitors may inhibit multiple intracellular targets. Indeed, in this study the JNK inhibitor SP600125 (which inhibits JNK1-3) also reduced ERK phosphorylation (Figure B.1B). Therefore, future studies using siRNA approaches, which can target the RNAs of individual protein or isoforms for degradation, would help to confirm the requirement of specific signalling molecules in regulating MMP-1 expression in gingival fibroblasts. The MMP-1 and MMP-3 promoters are similar as both promoters have AP-1, Ets and NF- κ B binding sites; however, the MMP-3 promoter does not have a STAT binding site (Fanjul-Fernandez *et al.*, 2010). Therefore, it would be interesting in future studies to determine whether the synergistic regulation of MMP-3 production observed in leptin+IL-1 or leptin+pam2CSK4-stimulated hGFs (Chapter 4) is dependent on the same or different intracellular signalling pathways as observed for MMP-1.

In summary, the current study presents the first evidence that leptin activates the MAPK, JAK/STAT and PI3K signalling pathways in gingival fibroblasts. Additionally, the results presented in this chapter add mechanistic information regarding the synergy between leptin and IL-1/pam2CSK4 that enhances MMP-1 production in gingival

fibroblasts. Overall, these results demonstrate that leptin and pro-inflammatory mediators stimulate specific and coordinated gingival fibroblast signalling events that determine the production of the collagenase MMP-1.

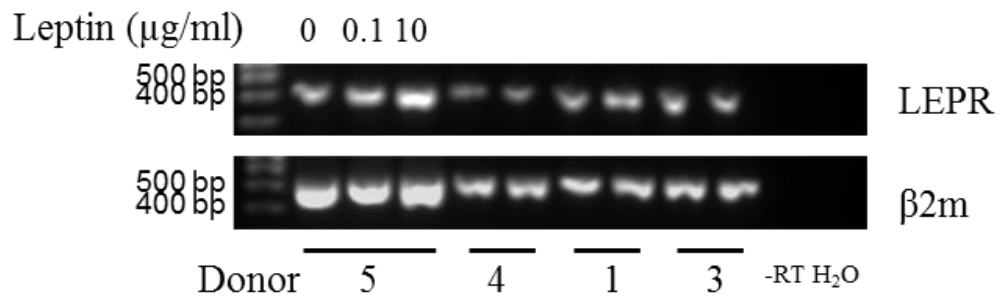

Figure 5.1: Long isoform leptin receptor gene expression in hGFs.

hGFs were either unstimulated (donors 1, 3, and 4) or were stimulated with leptin (0.1 or 10 $\mu\text{g/ml}$) (donor 5) for 24 h. Cells were lysed and cDNA was prepared by reverse transcription. The amount of RNA used for reverse transcription differed between donors. Semi-quantitative RT-PCR was used to assess leptin receptor (long isoform) and $\beta 2\text{m}$ gene expression. The expected product size for the leptin receptor (long isoform) was 428 bp, and for $\beta 2\text{m}$ was 435 bp. Long isoform leptin receptor expression was also confirmed in three other hGF donors. A dose-dependent increase in leptin receptor expression was also confirmed in another donor. LEPR – leptin receptor, $\beta 2\text{m}$ – $\beta 2$ -microglobulin.

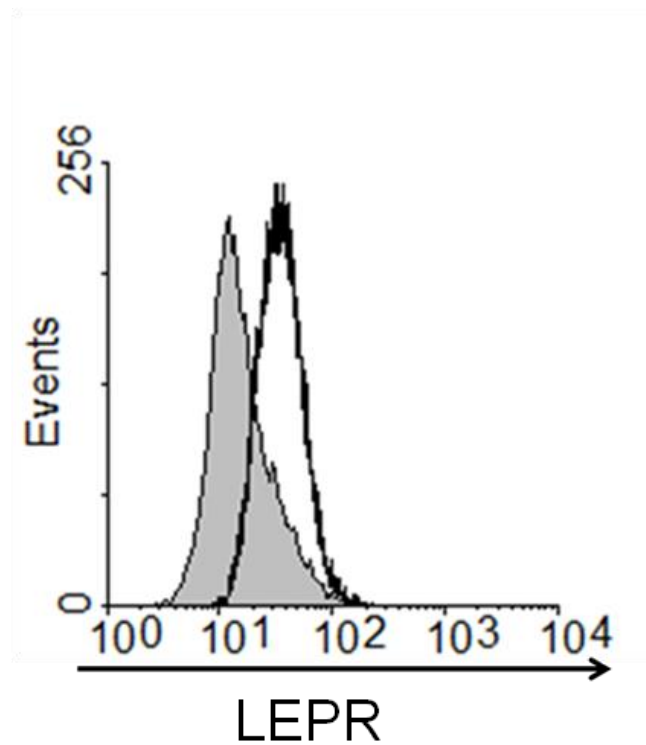

Figure 5.2: Leptin receptor surface expression on hGFs.

Unstimulated hGFs were prepared and analysed for cell surface leptin receptor expression by flow cytometry. Cells were stained with mouse anti-human leptin receptor PE-conjugated monoclonal antibody or isotype control antibody. 10000 gated events were acquired using a FACSCalibur flow cytometer. This histogram displays the events for leptin receptor staining (no fill) compared to an isotype control (grey fill) and are representative of results from 4 different hGF donors.

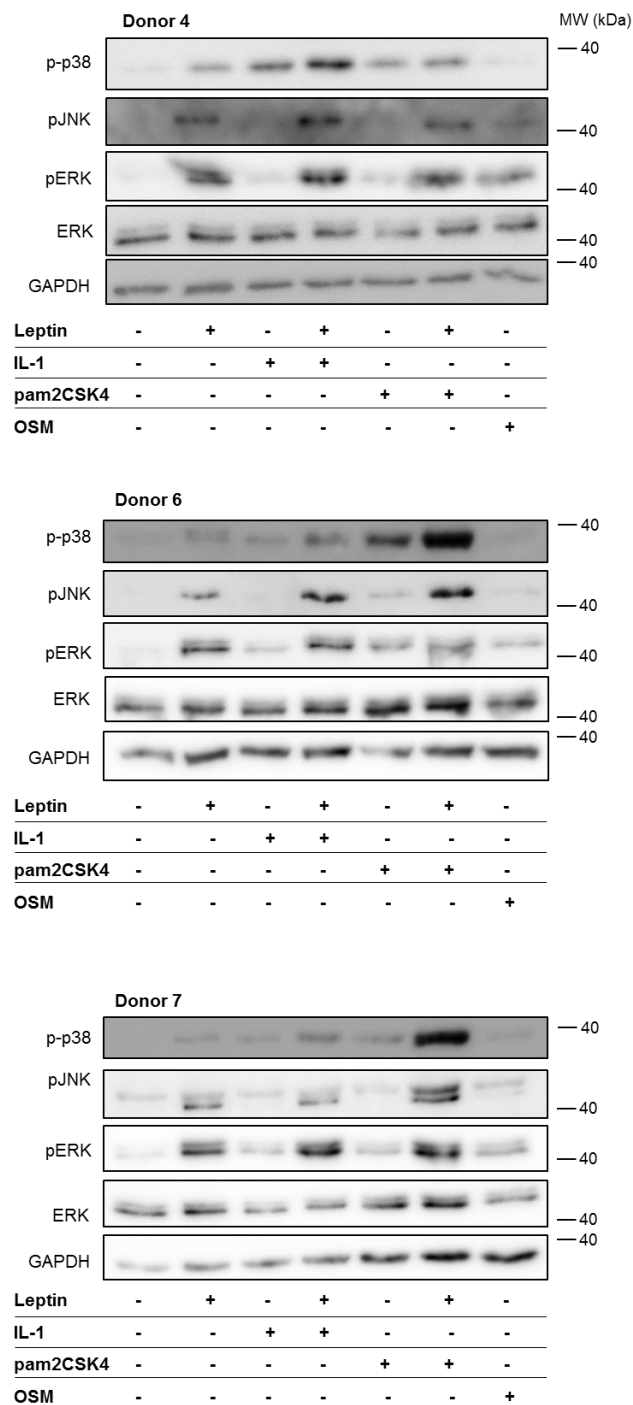

Figure 5.3: Phosphorylation status of MAPK signalling pathway intermediates in hGFs after stimulation with leptin, IL-1, pam2CSK4 and OSM.

hGFs were stimulated with leptin (10 $\mu\text{g/ml}$), IL-1 (0.05 ng/ml), leptin+IL-1 (leptin 10 $\mu\text{g/ml}$, IL-1 0.05 ng/ml), pam2CSK4 (50 ng/ml), leptin+pam2CSK4 (leptin 10 $\mu\text{g/ml}$, pam2CSK4 50 ng/ml) or OSM (5 ng/ml) for 20 min. Cells were lysed and prepared for SDS-PAGE. Extracts were immunoblotted with antibodies against phospho(p)-p38 (T180/Y182), pJNK (T183/Y185), pERK (p42/44) (T202/Y204), ERK (p42/44) and GAPDH as a loading control (the amino acids highlighted in these brackets represent the site/s of phosphorylation in the phospho-epitopes detected by these antibodies). The results from the three donors tested are displayed.

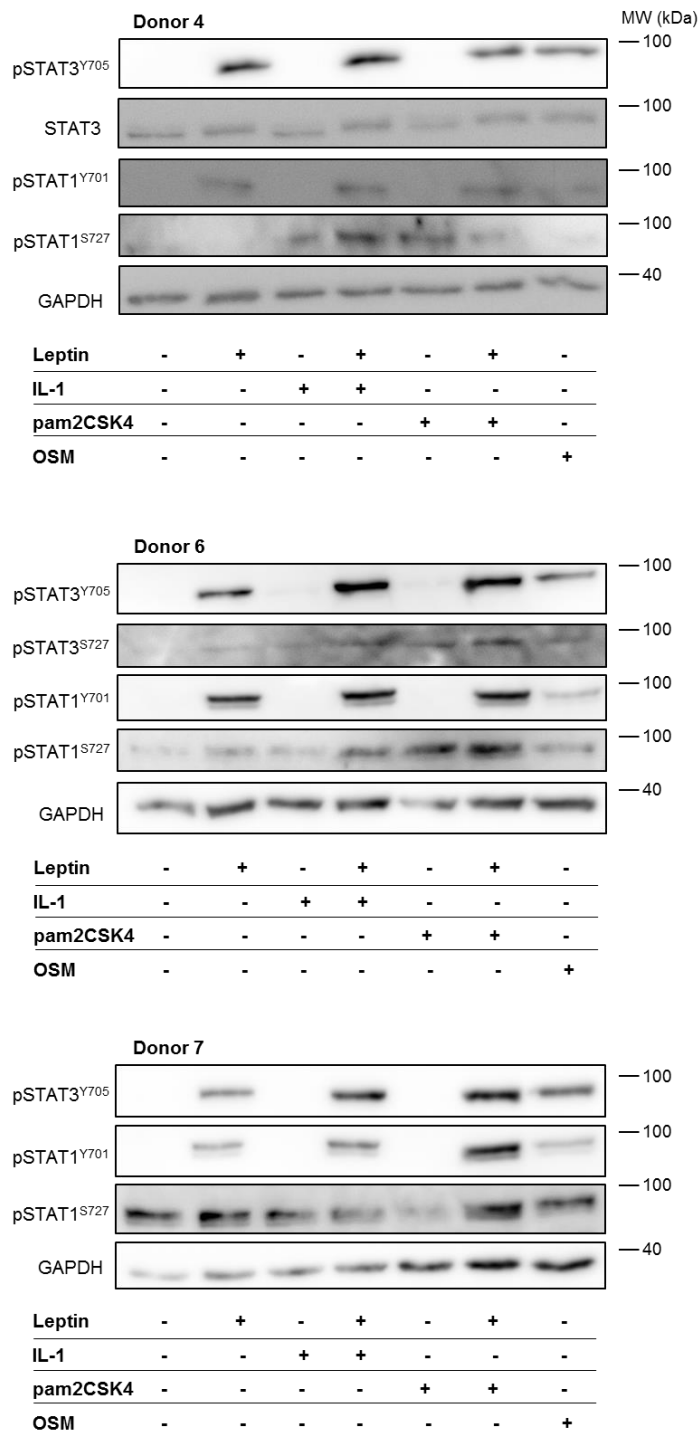

Figure 5.4: Phosphorylation status of STAT1 and STAT3 in hGFs after stimulation with leptin, IL-1, pam2CSK4 and OSM.

hGFs were stimulated with leptin (10 $\mu\text{g/ml}$), IL-1 (0.05 ng/ml), leptin+IL-1 (leptin 10 $\mu\text{g/ml}$, IL-1 0.05 ng/ml), pam2CSK4 (50 ng/ml), leptin+pam2CSK4 (leptin 10 $\mu\text{g/ml}$, pam2CSK4 50 ng/ml) or OSM (5 ng/ml) for 20 min. Cells were lysed and prepared for SDS-PAGE. Extracts were immunoblotted with antibodies against phospho(p)-STAT3 (Y705), pSTAT3 (S727), pSTAT1 (Y701), pSTAT1 (S727), STAT3 and GAPDH as a loading control (the amino acids highlighted in these brackets represent the site/s of phosphorylation in the phospho-epitopes detected by these antibodies). The results from the three donors tested are displayed.

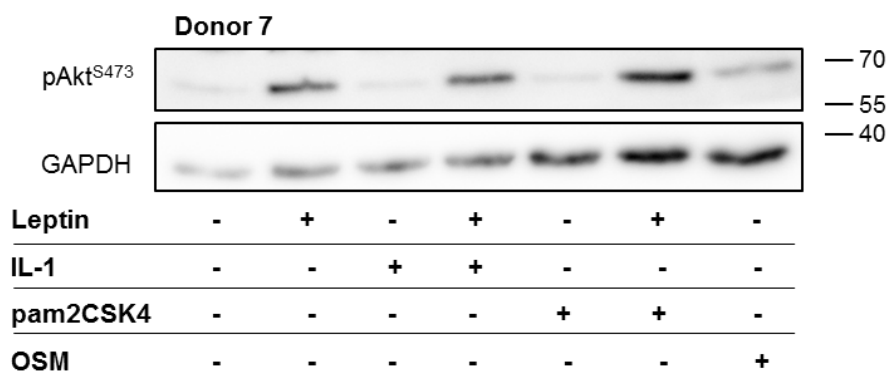
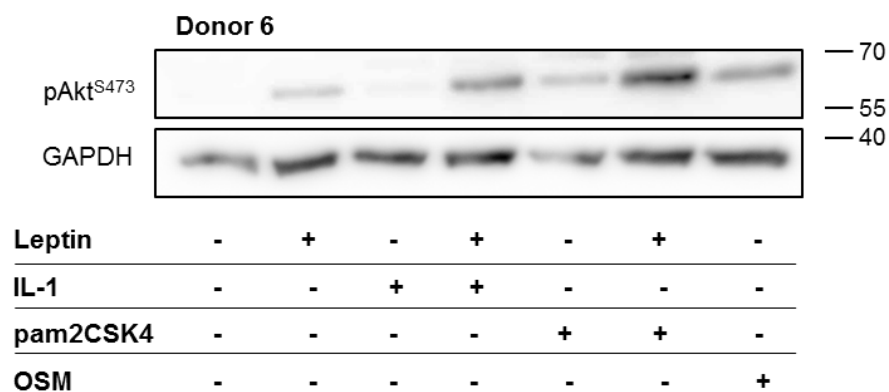
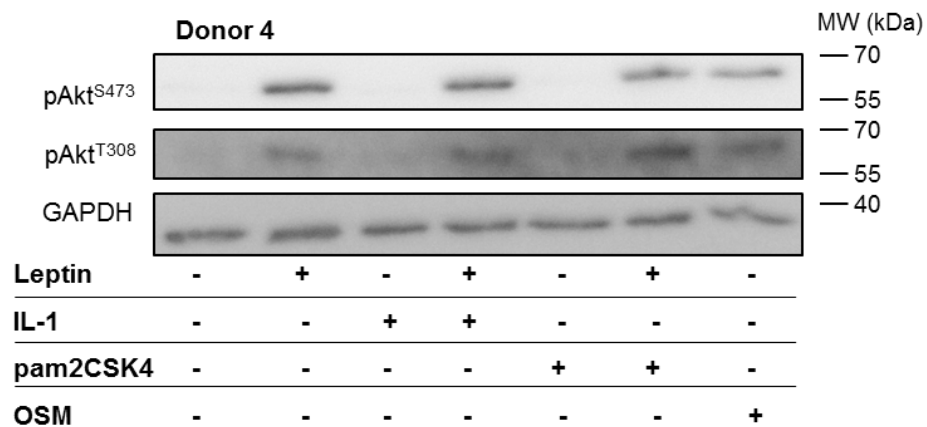

Figure 5.5: Phosphorylation status of Akt in hGFs after stimulation with leptin, IL-1, pam2CSK4 and OSM.

hGFs were stimulated with leptin (10 $\mu\text{g/ml}$), IL-1 (0.05 ng/ml), leptin+IL-1 (leptin 10 $\mu\text{g/ml}$, IL-1 0.05 ng/ml), pam2CSK4 (50 ng/ml), leptin+pam2CSK4 (leptin 10 $\mu\text{g/ml}$, pam2CSK4 50 ng/ml) or OSM (5 ng/ml) for 20 min. Cells were lysed and prepared for SDS-PAGE. Extracts were immunoblotted with antibodies against phospho(p)-Akt (S473), pAkt (T308) and GAPDH as a loading control (the amino acids highlighted in these brackets represent the site/s of phosphorylation in the phospho-epitopes detected by these antibodies). The results from the three donors tested are displayed. Phospho-Akt T308 was also assessed in donor 6 but no bands could be resolved for any treatment condition.

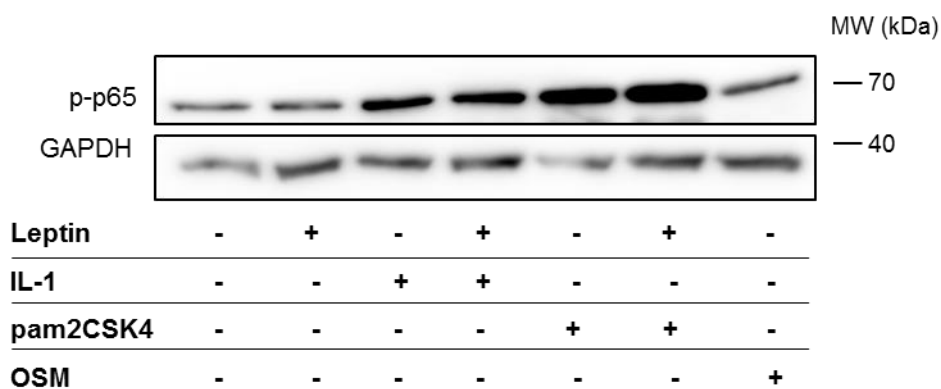

Figure 5.6: Phosphorylation status of NF- κ B p65 in hGFs after stimulation with leptin, IL-1, pam2CSK4 and OSM.

hGFs from one donor were stimulated with leptin (10 μ g/ml), IL-1 (0.05 ng/ml), leptin+IL-1 (leptin 10 μ g/ml, IL-1 0.05 ng/ml), pam2CSK4 (50 ng/ml), leptin+pam2CSK4 (leptin 10 μ g/ml, pam2CSK4 50 ng/ml) or OSM (5 ng/ml) for 20 min. Cells were lysed and prepared for SDS-PAGE. Extracts were immunoblotted with antibodies against phospho(p)-p65 (S536) and GAPDH as a loading control (the amino acid highlighted in this bracket represents the site of phosphorylation in the phospho-epitopes detected by these antibodies).

Table 5.1: The inhibitors of intracellular signalling pathway intermediates used in this study.

The inhibitors used were chosen as the intracellular targets that they inhibit are activated by leptin, IL-1 or pam2CSK4. The concentrations of inhibitors used did not cause toxicity in hGFs, and where tested inhibited their respective intracellular target (Section 2.2.6.1).

Inhibitor	Concentration (μM)	Intracellular target
U0126	7.5	MEK/ERK
SP600125	10	JNK
SB203580	10	p38
STAT3 inhibitor VI	100	STAT3
Akt inhibitor VIII	0.3	Akt
Bay 11-7085	10	NF- κ B

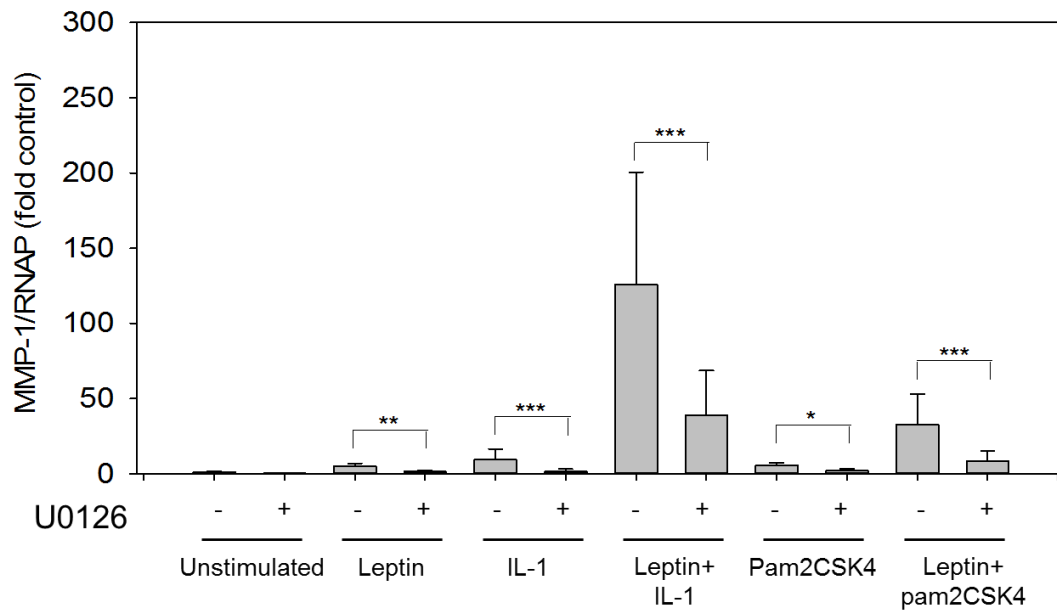

Figure 5.7: The role of MEK/ERK in regulating MMP-1 gene expression by stimulated hGFs.

hGFs were either pre-treated with 0.1 % v/v DMSO or the MEK inhibitor U0126 (7.5 μ M) for 30 min and then stimulated with leptin (10 μ g/ml), IL-1 α (0.05 ng/ml), leptin+IL-1 α (leptin 10 μ g/ml, IL-1 α 0.05 ng/ml), pam2CSK4 (50 ng/ml) or leptin+pam2CSK4 (leptin 10 μ g/ml, pam2CSK4 50 ng/ml) for 24 h. Cells were lysed and cDNA was prepared by reverse transcription. Real-time RT-PCR was used to assess MMP-1 and RNAP gene expression. Relative MMP-1 mRNA expression was determined using the $2^{-\Delta\Delta C_t}$ method by using RNAP as the reference gene. Data (fold unstimulated DMSO control) are shown as mean+SD (n=12) from three donors stimulated in independent experiments. Statistics: T tests for independent samples (Bonferroni-corrected) *=p<0.05, **=p<0.01, ***=p<0.001 as indicated.

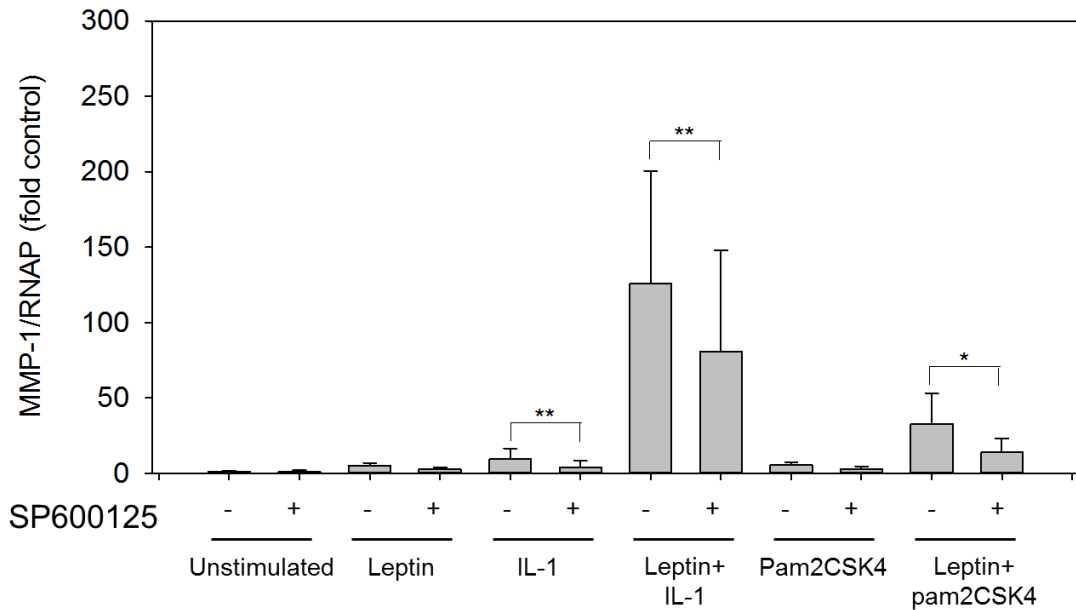

Figure 5.8: The role of JNK in regulating MMP-1 gene expression by stimulated hGFs.

hGFs were either pre-treated with 0.1 % v/v DMSO or the JNK inhibitor SP600126 (10 μ M) for 30 min and then stimulated with leptin (10 μ g/ml), IL-1 α (0.05 ng/ml), leptin+IL-1 α (leptin 10 μ g/ml, IL-1 α 0.05 ng/ml), pam2CSK4 (50 ng/ml) or leptin+pam2CSK4 (leptin 10 μ g/ml, pam2CSK4 50 ng/ml) for 24 h. Cells were lysed and cDNA was prepared by reverse transcription. Real-time RT-PCR was used to assess MMP-1 and RNAP gene expression. Relative MMP-1 mRNA expression was determined using the 2^{-ddCt} method by using RNAP as the reference gene. Data (fold unstimulated DMSO control) are shown as mean+SD (n=12) from three donors stimulated in independent experiments. Statistics: T tests for independent samples (Bonferroni-corrected) *=p<0.05, **=p<0.01 as indicated.

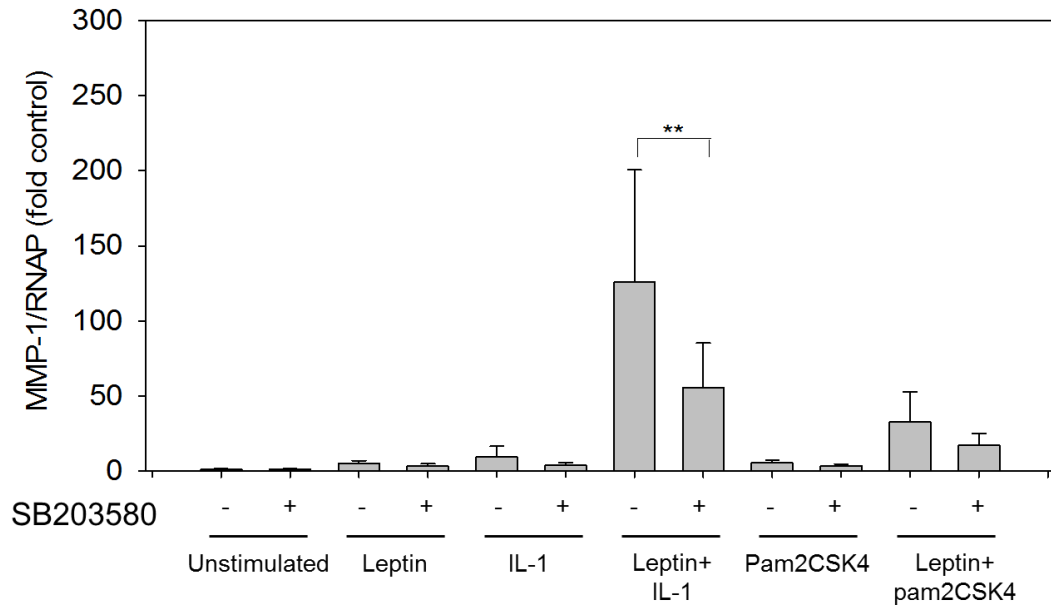

Figure 5.9: The role of p38 in regulating MMP-1 gene expression by stimulated hGFs.

hGFs were either pre-treated with 0.1 % v/v DMSO or the p38 inhibitor SB203580 (10 μ M) for 30 min and then stimulated with leptin (10 μ g/ml), IL-1 α (0.05 ng/ml), leptin+IL-1 α (leptin 10 μ g/ml, IL-1 α 0.05 ng/ml), pam2CSK4 (50 ng/ml) or leptin+pam2CSK4 (leptin 10 μ g/ml, pam2CSK4 50 ng/ml) for 24 h. Cells were lysed and cDNA was prepared by reverse transcription. Real-time RT-PCR was used to assess MMP-1 and RNAP gene expression. Relative MMP-1 mRNA expression was determined using the 2^{-ddCt} method by using RNAP as the reference gene. Data (fold unstimulated DMSO control) are shown as mean+SD (n=12) from three donors stimulated in independent experiments. Statistics: T tests for independent samples (Bonferroni-corrected) **=p<0.01 as indicated.

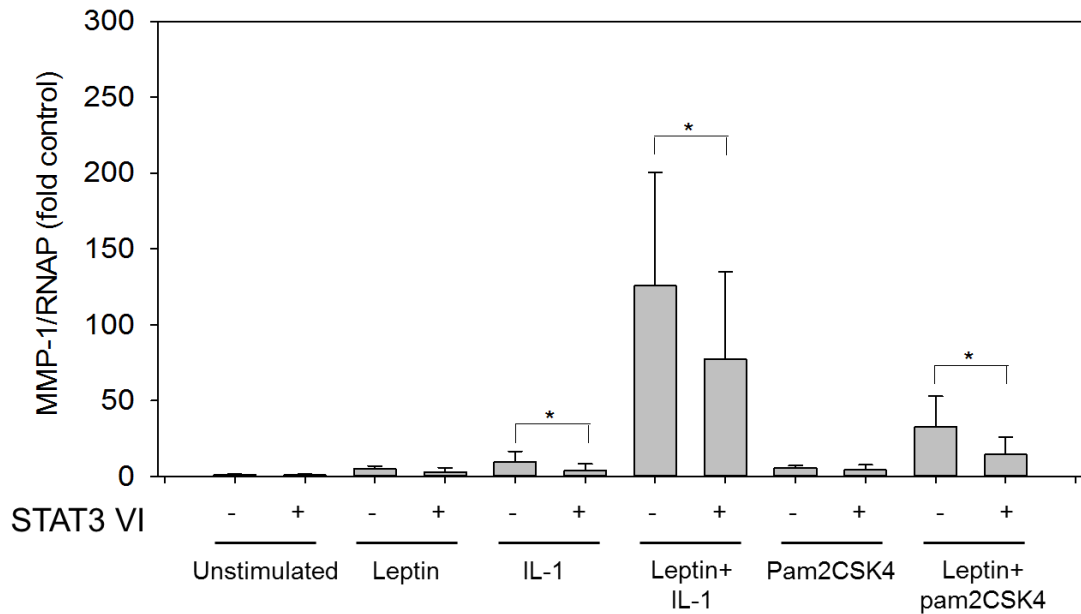

Figure 5.10: The role of STAT3 in regulating MMP-1 gene expression by stimulated hGFs.

hGFs were either pre-treated with 0.1 % v/v DMSO or STAT3 inhibitor VI (100 μ M) for 30 min and then stimulated with leptin (10 μ g/ml), IL-1 α (0.05 ng/ml), leptin+IL-1 α (leptin 10 μ g/ml, IL-1 α 0.05 ng/ml), pam2CSK4 (50 ng/ml) or leptin+pam2CSK4 (leptin 10 μ g/ml, pam2CSK4 50 ng/ml) for 24 h. Cells were lysed and cDNA was prepared by reverse transcription. Real-time RT-PCR was used to assess MMP-1 and RNAP gene expression. Relative MMP-1 mRNA expression was determined using the 2^{-ddCt} method by using RNAP as the reference gene. Data (fold unstimulated DMSO control) are shown as mean+SD (n=12) from three donors stimulated in independent experiments. Statistics: T tests for independent samples (Bonferroni-corrected) *= $p < 0.05$ as indicated.

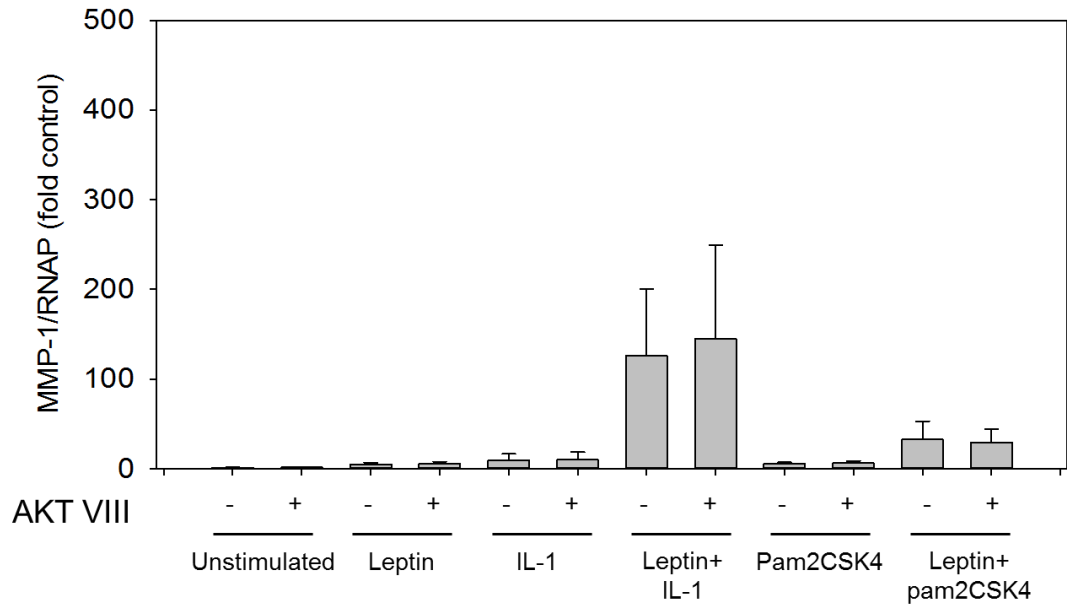

Figure 5.11: The role of AKT in regulating MMP-1 gene expression by stimulated hGFs.

hGFs were either pre-treated with 0.1 % v/v DMSO or AKT inhibitor VIII (0.3 μ M) for 30 min and then stimulated with leptin (10 μ g/ml), IL-1 α (0.05 ng/ml), leptin+IL-1 α (leptin 10 μ g/ml, IL-1 α 0.05 ng/ml), pam2CSK4 (50 ng/ml) or leptin+pam2CSK4 (leptin 10 μ g/ml, pam2CSK4 50 ng/ml) for 24 h. Cells were lysed and cDNA was prepared by reverse transcription. Real-time RT-PCR was used to assess MMP-1 and RNAP gene expression. Relative MMP-1 mRNA expression was determined using the $2^{-\Delta\Delta C_t}$ method by using RNAP as the reference gene. Data (fold unstimulated DMSO control) are shown as mean+SD (n=12) from three donors stimulated in independent experiments. Statistics: T tests for independent samples (Bonferroni-corrected).

6 Genome-wide expression profiling of gingival fibroblasts after stimulation with leptin and IL-1

6.1 Introduction

Gingival fibroblasts are implicated in maintaining the structural integrity of the gingiva by regulating the production of ECM-remodelling enzymes, as evidenced by the results of this study and by others previously (Chapters 3 and 4 and Section 1.11.1). However, gingival fibroblasts are also immunocompetent cells that are implicated in regulating inflammation; for example, gingival fibroblasts are a source of chemokines, cytokines and growth factors (Section 1.11).

Leptin regulates a broad range of inflammatory responses in a number of cell types (Section 1.4). In this study it was demonstrated that gingival fibroblasts stimulated with leptin (and IL-1) activated multiple intracellular signalling pathways (Chapter 5). These signalling pathways (MAPK, JAK/STAT, PI3K/Akt, NF- κ B) are implicated in regulating the production of a broad range of molecules in gingival fibroblasts, including molecules implicated in inflammation (Bodet *et al.*, 2007; Bage *et al.*, 2010; Hosokawa *et al.*, 2010b; Hosokawa *et al.*, 2010a; Gutiérrez-Venegas and Arreguín-Cano, 2011). For example, NF- κ B signalling is required to enhance LPS-stimulated IL-6 gene expression in gingival fibroblasts (Jin *et al.*, 2012). Therefore, it can be hypothesised that the effects of leptin on gingival fibroblast phenotype are widespread, and may affect inflammatory responses in these cells.

Aside from the current study, only one other study has investigated how leptin regulates gingival fibroblast responses (Park *et al.*, 2013). Together, these studies have only investigated the regulation of a limited profile of MMPs, TIMPs, and inflammatory mediators (IL-6 and CXCL8) in leptin-stimulated gingival fibroblasts. Therefore, a holistic understanding of the leptin(\pm IL-1)-stimulated gingival fibroblast phenotype is lacking.

Proteomic and genomic array-based technologies have been used to study gingival fibroblast responses previously (Han and Amar, 2002; Bodet *et al.*, 2007; Vardar-Sengul *et al.*, 2009; Bage *et al.*, 2010; Ebisawa *et al.*, 2011). Gene expression arrays have been used to compare gingival fibroblast phenotypes to other cells such as PDL fibroblasts, gingival epithelial cells, and dermal fibroblasts (Han and Amar, 2002; Abiko *et al.*, 2004; Ebisawa *et al.*, 2011). Using a DNA microarray with over 9000

unique probes, Han and Amar (2002) identified over 100 genes that are differentially expressed between PDL and gingival fibroblasts, thereby highlighting the intrinsic differences between these cells. Similarly, Ebisawa *et al.* (2011) found that only 5% of the approximately 5000 genes represented on a DNA microarray were differentially expressed between dermal and gingival fibroblasts; the authors suggest that understanding the differences in gene expression profiles between distinct fibroblast populations may assist in the development of cell-based therapies. Additionally, gene expression arrays have been used to compare the phenotype of cytokine (TNF- α , IL-1 β) stimulated gingival fibroblasts to unstimulated controls (Vardar-Sengul *et al.*, 2009; Bage *et al.*, 2010; Davanian *et al.*, 2012). For example, Bage *et al.* (2010) used a DNA microarray containing >37000 probes to determine that genes whose products are implicated in the JNK and NF- κ B signalling pathways are significantly overrepresented in TNF- α stimulated gingival fibroblasts compared to unstimulated controls. Subsequently, Bage *et al.* (2010) used chemical inhibitors of JNK and NF- κ B to show that these pathways regulate the increased production of PGE₂ by TNF- α stimulated gingival fibroblasts, thereby identifying intracellular signalling pathways that could be targeted to modulate the inflammatory responses of gingival fibroblasts.

In this study, Illumina beadchip microarray technology was chosen to profile the gingival fibroblast transcriptome after stimulation with leptin and IL-1 (Section 2.8.2 and Appendix E). Illumina microarrays contain oligonucleotides that are bound to microbeads, and these microbeads are randomly dispensed onto the microarray. This is in contrast to the other main array platforms (e.g. Affymetrix microarrays) which directly spot oligonucleotides onto the microarray. Another difference between the two microarray platforms is in the number and sequences of oligonucleotides used. For example, Affymetrix microarrays contain several different oligonucleotide probes for each gene (and oligonucleotides with one base mis-matched to control for non-specific hybridisation); in contrast, Illumina beadchip microarrays dispense multiple beads labelled with the same oligonucleotide. The advantage of this regarding the Illumina platform is that it allows for an assessment of technical variation for each oligonucleotide. Nonetheless, both platforms are widely used. (Barnes *et al.*, 2005)

The genome-wide expression microarray approach chosen in this study has several advantages to expression arrays with a more limited number of probes (e.g. 96-gene TLDA). Not only does the genome-wide expression array contain probes for genes which are hypothesised to be of interest (e.g. inflammatory mediators for this study),

but it also allows for the identification of novel genes (with known or unknown function) which may be regulated by leptin in gingival fibroblasts. Additionally, the genome-wide expression microarray contains probes for all of the MMPs and TIMPs that have been assessed in this study previously. Therefore, this approach may help to confirm the changes in MMP expression in leptin-stimulated gingival fibroblasts that have already been observed. Finally, the data acquired from the genome-wide expression analysis can be analysed using bioinformatics tools to identify biological processes or pathways that are differentially regulated in leptin-stimulated gingival fibroblasts (Section 2.8.2). These bioinformatics tools are used to highlight potential functions that are occurring under the conditions in which the samples were obtained (Huang da *et al.*, 2009). These processes and pathways may help to identify the biological functions that leptin(+IL-1)-stimulated gingival fibroblasts are performing.

The aims of the experiments presented in this chapter were to discover the genome-wide expression profile of gingival fibroblasts after stimulation with leptin (\pm IL-1), and thereby to identify whether leptin (\pm IL-1) affects the inflammatory phenotype of gingival fibroblasts. A sub-aim of the experiments presented in this chapter was to identify molecules relevant to ECM remodelling expressed by gingival fibroblasts stimulated by leptin (\pm IL-1) that may add to those previously studied (Chapters 3 and 4).

6.2 Expression of immune function genes in leptin-stimulated hGFs – pilot study

6.2.1 Gene expression analysis by TLDA

hGFs were stimulated with leptin (0.1, 1 or 10 μ g/ml) for 24 h, or left unstimulated. Cells were lysed, RNA extracted and cDNA was prepared. cDNA was loaded onto a human immune panel TLDA (Section 2.8.1), and gene expression was determined by real-time RT-PCR, to identify what effect leptin had on the expression of genes implicated in immune function in hGFs. The relatively small number of genes on this array allowed for simple and quick data analysis, and was therefore beneficial for this pilot investigation.

6.2.1.1 Chemokines and CSFs

The chemokines *CXCL10*, *CXCL8*, *CCL5*, *CXCL11* and *CCL2*, the chemokine receptor *CCR4*, and *CSF1* were expressed in leptin-stimulated hGFs (Table 6.1), which suggests that leptin-stimulated hGFs have the potential to regulate leukocyte chemotaxis and

proliferation. The chemokine *CXCL10* was most highly differentially expressed (+8.2-fold) after 1 µg/ml leptin stimulation compared to unstimulated cells.

6.2.1.2 Cell surface markers

The cell surface markers *CD8A*, *CD40*, *CD68*, *CD38* and *CD4* were expressed by leptin-stimulated hGFs (Table 6.1), which indicates that leptin-stimulated hGFs may express a number of proteins on the cell surface which function in immune responses. Expression of the cell surface marker CD80 was induced in hGFs stimulated with 1 µg/ml leptin compared to unstimulated cells. *HLA-DRA1* (major histocompatibility complex, class II, DR α) and *ICAM1* were expressed in leptin-stimulated hGFs (Figure D.1A). *HLA-DRA1* and *ICAM1* expression levels were higher in hGFs stimulated with 10 µg/ml leptin compared to those stimulated with 0.1 µg/ml leptin.

6.2.1.3 Intracellular signalling molecules

STAT3, *NFKB2* (NF- κ B2) and *IKKBK* (inhibitor of κ B kinase- β) were expressed in leptin-stimulated hGFs (Table 6.1). Interestingly, *STAT3* expression was increased 2.4-fold in hGFs stimulated with 1 µg/ml leptin compared to unstimulated cells, which suggests that leptin enhances the ability of hGFs to signal via *STAT3*.

6.2.1.4 Immune and inflammatory mediators

The interleukins *IL6*, *IL15*, *IL12A*, *IL7* and *IL18* were expressed by leptin-stimulated hGFs (Table 6.1), which suggests that leptin-stimulated hGFs may be a source of cytokines in the gingiva. *IL6* was most highly differentially expressed interleukin (+8.0-fold) after stimulation with 1 µg/ml leptin compared to unstimulated cells. *C3* (complement component 3) and *TGFBI* (TGF- β 1) were expressed in leptin-stimulated hGFs (Figure D.1B). The expression levels of both *C3* and *TGFBI* were higher in hGFs stimulated with 10 µg/ml leptin compared to those stimulated with 0.1 µg/ml leptin.

6.2.1.5 Other genes

VEGF, *ACE* (angiotensin 1 converting enzyme), *ECE1* (endothelin converting enzyme 1) and *EDN1* (endothelin 1), whose gene products are implicated in vascular functions, were expressed in leptin-stimulated hGFs (Figure D.1C). *COL4A5* (collagen, type IV, α 5) and *FNI* (fibronectin 1), whose gene products comprise ECM components, were expressed by hGFs after stimulation with leptin (Figure D.1D).

6.2.2 *Leptin-stimulated hGFs increase IL-6 secretion*

Protein levels of IL-6 were investigated in hGF supernatants to identify whether the leptin-stimulated increase in IL-6 mRNA levels translated to IL-6 secretion. In addition, hGFs were stimulated with IL-1 to determine whether leptin and IL-1 synergistically regulate IL-6 production similar to that observed regarding MMP-1 and MMP-3 production (Chapter 4). hGFs were stimulated with leptin (0.1, 1 or 10 µg/ml) with or without IL-1α (0.05 ng/ml) for 24 h. IL-6 concentrations in the supernatants were measured by ELISA. Unstimulated hGFs served as a negative control. No statistical analysis was performed because only 2 experimental replicates were analysed.

Leptin appeared to dose-dependently increase IL-6 secretion by hGFs (Figure 6.1). IL-1-stimulated hGFs also appeared to produce higher levels of secreted IL-6 compared to the unstimulated control (IL-1: 34±0.4 pg/ml, unstimulated: 12±0.8 pg/ml).

Interestingly, at least 8-fold higher levels of IL-6 protein were produced by hGFs stimulated with leptin+IL-1 compared to either IL-1 or leptin alone, indicating that MMPs are not the only molecules synergistically upregulated by leptin and IL-1 in hGFs.

6.3 Genome-wide expression analysis in hGFs stimulated with leptin and IL-1

Several preliminary studies were required to be performed prior to genome-wide expression analysis in hGFs. These studies were performed to:

1. Assess whether IL-1α and IL-1β similarly stimulated hGFs, as IL-1β was available to be used to stimulate hGFs in genome-wide expression experiments.
2. Check that the RNA samples prepared for the microarray were from successful stimulations.
3. Ensure sample RNA yield and quality were suitable for microarray analysis.

6.3.1 *IL-1α and IL-1β similarly regulate MMP-1 expression in hGFs*

hGFs were stimulated with IL-1α or IL-1β (both 0.05 ng/ml) for 24 h. Unstimulated hGFs served as a control. Cells were lysed and cDNA was prepared by reverse transcription. MMP-1 gene expression was assessed by real-time RT-PCR, and MMP-1 concentrations in the hGF supernatants were assessed by ELISA, to determine whether IL-1α and IL-1β stimulate hGFs in a comparable manner. Additionally, proliferation was assessed to determine whether IL-1α and IL-1β differentially regulate hGF proliferation as per Section 2.5.1 (Figure J.1).

Both IL-1 α and IL-1 β significantly increased MMP-1 gene expression and protein secretion compared to unstimulated hGFs (all $p < 0.001$) (Figure 6.2 and Figure 6.3). No significant difference in MMP-1 gene expression was detected between IL-1 α and IL-1 β stimulated hGFs. However, IL-1 β -stimulated hGFs secreted 79 % more MMP-1 compared to IL-1 α -stimulated hGFs ($p < 0.001$). IL-1 α and IL-1 β had no significantly different ability to regulate hGF proliferation (Figure J.1). These results confirm that IL-1 α and IL-1 β regulate MMP-1 gene expression and proliferation in hGFs to a similar extent. The finding that IL-1 β promotes higher MMP-1 secretion than IL-1 α suggests that IL-1 α and IL-1 β have a differential ability to regulate post-transcriptional processing of MMP-1 in hGFs.

6.3.2 Generation of successful stimulations and high quality RNA

hGFs were stimulated with leptin (10 $\mu\text{g/ml}$), IL-1 β (0.05 ng/ml) or leptin+IL-1 β (leptin 10 $\mu\text{g/ml}$, IL-1 β 0.05 ng/ml) for 24 h (6-well and 96-well formats). Unstimulated hGFs served as a control. 96-well format stimulations were performed in parallel to allow for statistical analysis; the number of cells required for 6-well format stimulations prohibited the seeding of >2 wells per treatment condition. Cells were lysed and cDNA was prepared by reverse transcription. MMP-1 gene expression was assessed by real-time RT-PCR. As well as RNA being extracted from the samples, the supernatants were collected to allow for the study of secreted products by hGFs.

Stimulations were designated successful if leptin and IL-1 β treated hGFs significantly ($p < 0.05$) increased MMP-1 gene expression compared to the unstimulated control, and if leptin+IL-1 β treated hGFs had significantly ($p < 0.05$) increased MMP-1 gene expression compared to hGFs stimulated with leptin and IL-1 β alone (e.g. synergy evident) as observed previously (Section 4.2.1). Successful stimulations were generated from hGFs isolated from donors 2, 3 and 4 (Figure 6.4). The same patterns of MMP-1 expression were detected for samples generated from the parallel 6-well stimulations (Figure J.2).

RNA isolated from hGFs (6-well format) was assessed for yield and quality by spectrophotometer (Table J.1). The minimum concentration for microarray analysis was 50 $\text{ng}/\mu\text{l}$. The RNA samples generated for microarray analysis had concentrations ≥ 125 $\text{ng}/\mu\text{l}$. Similarly, the RNA absorbance ratios A260/280 and A260/230 should be above 1.8. This was fulfilled for all but two of the RNA samples generated (donor 3, leptin and

IL-1 β stimulations) (Table J.1). These samples were sent for genome-wide expression analysis at CGS where all RNA samples passed additional QC (Section 2.8.2).

6.3.3 Overview of genome-wide expression results

The dataset acquired was normalised, subject to QC and corrected for unwanted variation (Section 2.8.2). Differentially expressed genes were then identified according to the methods (Section 2.8.2).

The profile (displayed as a heat map) of the relative expression levels of differentially expressed genes in hGFs stimulated with leptin, IL-1 or leptin+IL-1 were compared to the unstimulated control by hierarchical clustering (Figure E.3). Hierarchical clustering is a data analysis approach that groups samples depending on how similar each sample dataset is to the datasets of the other samples. These heat maps show that for each comparison the samples group by treatment condition. Also, in hGFs stimulated with leptin, IL-1 and leptin+IL-1 both increased and decreased levels of expression of the differentially expressed genes were observed compared to unstimulated hGFs. Additionally, these heat maps showed that the relative expression levels between different genes for each RNA sample were highly variable.

Leptin, IL-1 and leptin+IL-1-stimulated hGFs had 1599 genes in common that were expressed at a significantly different level ($p < 0.01$) to unstimulated hGFs (Figure 6.5). Leptin+IL-1-stimulated hGFs had more unique genes expressed at a significantly different level ($p < 0.01$) than leptin or IL-1 stimulated hGFs (leptin+IL-1 2105 genes, leptin 392 genes, IL-1 548 genes). IL-1 and Leptin+IL-1 stimulated hGFs shared more genes expressed at a significantly different level ($p < 0.01$) than leptin+IL-1 and leptin stimulated hGFs (583). Leptin and IL-1 stimulated hGFs shared 123 unique genes expressed at a significantly different level ($p < 0.01$) compared to leptin+IL-1 stimulated hGFs or the unstimulated control.

6.3.4 Differentially expressed genes in hGFs stimulated with leptin

Leptin-stimulated hGFs had 111 differentially expressed genes compared to unstimulated hGFs (Table 6.2). *CCL2*, *IL18BP* (IL-18 binding protein) and *IL6* were among the genes most highly upregulated in leptin-stimulated hGFs; while *ADAM19* (ADAM metalloproteinase domain 19) was one of only a few genes that were downregulated by leptin treatment. Interestingly, ADAM19 is a membrane-anchored protein that has extracellular protease activity (Qi *et al.*, 2009), and therefore, this

finding adds evidence to the earlier results (Chapter 3) that suggest leptin plays a role in regulating hGF-mediated ECM remodelling.

MMP1 was not differentially expressed in leptin-stimulated hGFs compared to unstimulated hGFs. Further profiling of the dataset revealed that MMP-1 expression was increased 2.7-fold in leptin-stimulated hGFs compared to unstimulated hGFs. However, the adjusted p value was 0.017 and therefore, *MMP1* did not make the p value cut-off of 0.01.

GO analysis identified 44 significant processes ($p < 0.001$) differentially regulated in leptin-stimulated hGFs compared to unstimulated hGFs (Table 6.3). The processes highlighted were relevant to immune function such as cytokine responses, and cell activation. KEGG pathway analysis identified 13 pathways significantly ($p < 0.01$) overrepresented in leptin-stimulated hGFs compared to unstimulated hGFs (Table 6.4). The pathways identified were relevant to immune function such as cytokine and TLR signalling, and metabolism. These enrichment analyses suggest that leptin enhances the immune function of hGFs.

6.3.5 Differentially expressed genes in hGFs stimulated with IL-1

IL-1-stimulated hGFs had 263 differentially expressed genes compared to unstimulated hGFs (Table 6.5). *IL8*, *IL6* and *CXCL6* were among the genes most highly upregulated in IL-1-stimulated hGFs. Similar to leptin-stimulated hGFs, *ADAM19* was one of relatively few genes that were downregulated in IL-1-stimulated hGFs compared to unstimulated hGFs. In contrast to leptin-stimulated hGFs, *MMP1* was differentially expressed in IL-1-stimulated hGFs (+4.3-fold, $p = 0.00086$ compared to unstimulated hGFs); this is in agreement with the earlier results in this study (Section 4.2), and supports the suggestion that IL-1 stimulates hGF-mediated collagen remodelling. Other genes relevant to ECM remodelling, namely *MMP3* and *COL8A1* (collagen, type VIII, $\alpha 1$) were differentially expressed in IL-1-stimulated hGFs (Table 6.5).

GO analysis identified 153 significant processes ($p < 0.001$) differentially regulated in IL-1-stimulated hGFs compared to unstimulated hGFs (Table 6.6). The processes highlighted were relevant to immune responses, inflammation, and responses to wounding. KEGG pathway analysis identified 10 pathways significantly ($p < 0.01$) overrepresented in IL-1-stimulated hGFs compared to unstimulated hGFs (Table 6.7). The pathways identified were relevant to metabolism and immune function (e.g. innate

pathogen recognition and cytokine/chemokine signalling). These enrichment analyses suggest that IL-1 enhances the immune and inflammatory functions of hGFs.

6.3.6 Differentially expressed genes in hGFs stimulated with leptin+IL-1

Leptin+IL-1-stimulated hGFs had 637 differentially expressed genes compared to unstimulated hGFs (Table 6.8). Similar to IL-1-treated hGFs, *IL8*, *IL6* and *CXCL6* were among the genes most highly upregulated in leptin+IL-1-stimulated hGFs. *COL6A3* (collagen, type VI, $\alpha 3$) and *TIMP3* whose protein products function in ECM homeostasis and the gene encoding the cytokine TGF- $\beta 3$ (*TGFB3*) were among the genes downregulated in leptin+IL-1-stimulated hGFs compared to unstimulated hGFs. The genes encoding several proteases (*MMP3*, *MMP1*, *CTSL* – cathepsin L, *PLAT* – tissue plasminogen activator, *MMP8*, *MMP2*, *MMP14*, *MMP12*) were upregulated in leptin+IL-1 stimulated hGFs compared to unstimulated hGFs. In contrast, compared to unstimulated hGFs the genes encoding several collagen proteins (*COL8A2*, *COL5A1*, *COL15A1*, *COL14A1*) were downregulated in leptin+IL-1 stimulated hGFs, which suggests that the production of some collagen proteins is reduced in hGFs exposed to leptin and IL-1.

GO analysis identified 255 significant processes ($p < 0.001$) differentially regulated in leptin+IL-1 stimulated hGFs compared to unstimulated hGFs (Table 6.9). The processes highlighted were relevant to wound responses and inflammation, immune system function, and anatomical development. KEGG pathway analysis identified 17 pathways significantly ($p < 0.01$) overrepresented in leptin+IL-1-stimulated hGFs compared to unstimulated hGFs (Table 6.10). The pathways identified were related to immune responses and immune pathology, metabolism, interactions with the ECM, and cancer. The genes overrepresented in the RA pathway are displayed as an example (Figure 6.6). Interestingly, the products of the genes overrepresented in the RA pathway are implicated in immune cell infiltration (*CCL2*, *CCL20*, *CXCL1*, *CXCL5*, and *CXCL8*), inflammation (*IL-6*) and joint destruction (*MMP-1*, *MMP-3*). These enrichment analyses suggest that leptin+IL-1 enhance immune and inflammatory functions in hGFs, but also affect ECM homeostasis.

6.3.7 Genes synergistically regulated by leptin+IL-1 in hGFs

Several similarities emerged from the analysis of the differentially expressed genes in leptin, IL-1 and leptin+IL1 stimulated hGFs. For example, in each list *IL6* was one of the most highly upregulated genes (Table 6.2, Table 6.5 and Table 6.8). Similarly,

immune system processes and pathways were significantly overrepresented in GO analysis and KEGG pathway analysis for leptin, IL-1 and leptin+IL-1 stimulated hGFs compared to unstimulated hGFs.

Two additional differentially expressed gene lists were created: leptin v leptin+IL-1, and IL-1 v leptin+IL-1 (Section 2.8.2). Using these lists a new list of genes potentially synergistically regulated by leptin and IL-1 in hGFs was created (Table 6.11). Genes were selected for this list if they fulfilled the following properties:

1. The gene was differentially expressed in leptin+IL-1 stimulated hGFs compared to the unstimulated control.
2. The fold change in gene expression was greater after leptin+IL-1 stimulation than either leptin or IL-1 stimulation alone, or the gene was not present in the leptin or IL-1 gene lists.
3. The gene encodes a protein which has a function implicated in immunity or ECM remodelling as determined by literature search

The genes in Table 6.11 that were differentially expressed in both of the additional genes lists were highlighted as significantly synergistically regulated by leptin+IL-1 in hGFs in this genome-wide expression analysis. For example, using this analysis *MMP3*, *IL24* and *CXCL5* were synergistically regulated by leptin+IL-1 in hGFs. *MMP1* was also synergistically regulated by leptin+IL-1 in hGFs in this microarray analysis, which is in agreement with previous real-time RT-PCR analyses of MMP-1 gene expression in this study (Chapter 4). Interestingly, several other MMP genes (*MMP8*, *MMP2*, *MMP14*, and *MMP12*) were identified in Table 6.11; however only *MMP8* was confirmed as being synergistically regulated by leptin+IL-1.

6.3.8 Further analysis of selected genes by real-time RT-PCR

Several genes identified in the genome-wide expression analysis were selected for further study by real-time RT-PCR, namely *MMP3*, *IL24*, *MMP8*, *MMP2*, *MMP14*, *MMP12*, *TIMP3*, *COL6A3*. These genes were selected firstly to validate the microarray, and secondly because either they were significantly synergistically regulated by leptin and IL-1 in hGFs (*MMP3*, *IL24*, *MMP8*); or because these genes were potentially synergistically regulated by leptin and IL-1 in hGFs (e.g. present in Table 6.11), and their protein product is implicated in ECM homeostasis (*MMP2*, *MMP14*, *MMP12*, *TIMP3*, *COL6A3*). MMP-1 gene expression was not further studied as this was

performed prior to the microarray (Section 6.3.2). The same RNA generated in Section 6.3.2 was freshly converted to cDNA by reverse transcription.

Leptin and IL-1 synergised to increase MMP-3, IL-24, MMP8 and MMP-12 gene expression in hGFs (Figure 6.7A-D). Leptin+IL-1 stimulated hGFs increased MMP-3 gene expression 316-fold and 5.2-fold compared to leptin and IL-1 stimulated hGFs respectively (both $p < 0.001$). Similarly, leptin+IL-1 stimulated hGFs increased IL-24 gene expression 292-fold and 375-fold compared to leptin and IL-1 stimulated hGFs respectively (both $p < 0.01$). Leptin+IL-1 stimulated hGFs increased MMP-8 gene expression 32-fold and 15-fold compared to leptin and IL-1 stimulated hGFs respectively (both $p < 0.001$). Also, Leptin+IL-1 stimulated hGFs increased MMP-12 gene expression 58-fold and 5.9-fold compared to leptin and IL-1 stimulated hGFs respectively (leptin $p < 0.001$, IL-1 $p < 0.01$).

No synergy between leptin and IL-1 was observed regarding MMP-14 and MMP-2 expression (Figure 6.7E-F). Only leptin (\pm IL-1) stimulated MMP-14 gene expression in hGFs compared to the unstimulated control ($p < 0.05$), which is in agreement with previous results in this study (Section 4.2.3). In contrast, only IL-1 (\pm leptin) stimulated hGFs significantly increased MMP-2 gene expression compared to the unstimulated control ($p < 0.01$).

Interestingly, leptin and IL-1 synergised to decrease *COL6A3* expression in hGFs (Figure 6.7G). Leptin+IL-1 stimulated hGFs decreased *COL6A3* expression 55 % and 35 % compared to leptin and IL-1 stimulated hGFs respectively (leptin $p < 0.001$, IL-1 $p < 0.01$). In contrast, no significant differences in TIMP-3 gene expression were observed after any combination of leptin and IL-1 stimulation in hGFs compared to the unstimulated control (Figure 6.7H).

6.3.9 IL-24 secretion by hGFs stimulated with leptin and IL-1

A literature search of IL-24 revealed that no previous studies had identified differential IL-24 gene expression in gingival fibroblasts, or after leptin stimulation in any cells. To further investigate this novel finding, IL-24 secretion by hGFs was assessed by measuring the concentration of IL-24 protein by ELISA in the supernatants from the samples used for genome-wide expression analysis (Sections 6.3).

Leptin and IL-1 synergistically regulated IL-24 secretion by hGFs (Figure 6.8). No IL-24 was detected in the supernatants of unstimulated hGFs or cells stimulated with IL-1

but, IL-24 was detected in the supernatants of leptin-stimulated hGFs. Interestingly, the concentration of IL-24 in leptin+IL-1-stimulated hGF supernatants was 68-fold higher than that detected in the supernatants of leptin-stimulated hGFs ($p < 0.01$).

6.4 Discussion

Leptin regulates immune and inflammatory responses by altering cellular immunocompetence (Matarese *et al.*, 2005). Gingival fibroblast phenotypes are altered by inflammatory mediators, but the particular phenotype generated depends on the stimuli gingival fibroblasts are exposed to (Mahanonda *et al.*, 2007; Uehara and Takada, 2007; Belibasakis and Guggenheim, 2011). I have shown that gingival fibroblasts express cell surface leptin receptor, and respond to leptin stimulation by activating intracellular signalling pathways and increasing the production of several MMPs (Chapters 3-5). Only one study has investigated the ability of leptin to regulate the production of inflammatory mediators by gingival fibroblasts, but only two mediators were studied (Park *et al.*, 2013). No genome-wide expression analysis has been reported in leptin-stimulated hGFs or indeed in leptin-stimulated fibroblasts from any anatomical site, therefore the results presented in this chapter are entirely novel. The results presented in this chapter suggest that leptin enhances the immunocompetence of hGFs, by promoting the expression of several mediators that are implicated in inflammation. In addition, leptin and IL-1 synergistically stimulated the expression of a number of mediators that are implicated in inflammation and tissue remodelling, such as chemokines, cytokines and MMPs. These results suggest that the way in which leptin regulates hGF phenotype differs in the absence and presence of IL-1, and add to the body of evidence that gingival fibroblasts are an important regulator of immune responses and inflammation in the gingiva (Section 1.11).

In this study leptin increased the expression of three genes in hGFs whose products are implicated in antigen processing and presentation (*HLA-DRA*, *HLA-DMA*, and *CTSL*). Increased expression levels of the MHC class II molecule *HLA-DRA* and cathepsin L have been observed in cytokine-stimulated gingival fibroblasts previously (Cox *et al.*, 2006; Mahanonda *et al.*, 2008). *HLA-DRA* encodes the α -subunit of one of the cell surface MHC class II molecules, and functions to present exogenous peptide antigens to T cells (Blum *et al.*, 2013). *HLA-DMA* encodes the α -subunit of one of the intracellular MHC class II molecules which assists in antigen presentation by promoting the binding of peptides to the cell surface MHC class II molecules (e.g. *HLA-DR*) (Brocke *et al.*, 2002). The lysosomal protease cathepsin L assists in antigen processing by producing

peptides that can be bound to MHC class II molecules by degrading proteins in the endocytic pathway (Blum *et al.*, 2013). Together, these results suggest that leptin may increase the ability of gingival fibroblasts to act as professional antigen presenting cells, thereby assisting in the activation of lymphocytes in the gingiva. However, only the α -subunit of these MHC class II molecules was upregulated in this study. This suggests that the increased expression levels of *HLA-DRA* and *HLA-DMA* may not translate to HLA-DR and HLA-DM protein levels because the protein is a heterodimer consisting of both α - and β -subunits.

Cathepsin L is also implicated in the turnover of ECM molecules, and the activation of MMPs (Uitto *et al.*, 2003). Two other enzymes with proteolytic activity were differentially regulated in leptin-stimulated hGFs in this study (*ADAMTS1* was upregulated, *ADAM19* was downregulated). *ADAM19* is a transmembrane protein that is implicated in cleaving a variety of substrates including ECM components, growth factors and cytokines (Qi *et al.*, 2009). *ADAMTS1* is a secreted protein, often associated with ECM components, which cleaves a wide range of protein substrates and is upregulated by leptin in murine ovarian follicles (Barkan *et al.*, 2005). These results add to the earlier findings in this study that suggest that leptin affects the ECM degrading potential of hGFs (Chapter 3 and 4). However, in the microarray analysis performed in this study, leptin alone had no significant ability to alter the expression of any of the MMPs previously investigated. This discrepancy is likely due to the stringent fold change and p value cut offs selected during analysis of the microarray expression dataset (as determined for MMP-1 in Section 6.3.4). Further studies are required to determine whether leptin-stimulated alterations in protease expression by gingival fibroblasts play a functional role in ECM remodelling in the gingiva.

In this study leptin increased the expression of genes whose products are cell surface receptors for molecules implicated in inflammation and immunity (*CD14*, *IL13RA1*, *IL1R1*, and *FAIM3*). The transmembrane protein *CD14* binds LPS and promotes TLR4 signalling (Lu *et al.*, 2008). I have shown that TLR4 is expressed on hGFs (Section 4.3.2.4). Together, this suggests that leptin may promote LPS-stimulated TLR4 signalling in hGFs, although perhaps only in individuals who are responsive to LPS given the donor-dependent differences in LPS-stimulated MMP production observed previously (Section 4.3.2). *IL13RA1* encodes one of the subunits of the heterodimeric IL-13 receptor which can bind the Th2-type cytokines IL-13 and IL-4 (Preshaw and Taylor, 2011). This suggests that leptin-stimulated hGFs have an increased ability to

detect these Th2-type cytokines. However, the other subunit of the IL-13 receptor (*IL4RA*) was not similarly upregulated by leptin in hGFs, suggesting that the increased expression of *IL13RA1* detected in this study may not translate to increased IL-13 receptor protein levels. The type I IL-1 receptor is encoded by *IL1RI*, and can bind IL-1 α , IL-1 β and the IL-1 receptor antagonist (Preshaw and Taylor, 2011). However, signal transduction downstream of the type I IL-1 receptor requires an accessory protein (*IL1RAP*) (Bowie and O'Neill, 2000), which was not similarly increased after leptin stimulation. Therefore, it is unclear whether leptin-stimulated gingival fibroblasts would have an increased ability to activate IL-1 signalling. *FAIM3* has recently been found to encode an Fc receptor for IgM (Kubagawa *et al.*, 2009). IgM is the first antibody isotype produced by plasma cells and is thought to be present at only low levels outside of the circulation. However, there is evidence that GCF IgM concentrations increase during the course of experimental gingivitis and during gingival trauma (Griffiths *et al.*, 1997). Together with the increases in expression of genes relevant to antigen presentation discussed earlier, this suggests that leptin increases the ability of gingival fibroblasts to bind IgM, potentially preparing gingival fibroblasts for antigen sampling and presentation should an injury or inflammatory state arise in the gingiva.

Several genes (e.g. *BCL3*, *BCL6*, *STAT1*, *ATF3*, *MAP3K8*, *SOCS3*) encoding molecules involved in intracellular signalling and gene transcription were upregulated in leptin-stimulated hGFs in this study. *STAT1*, *ATF3* and *BCL6* encode transcription factors while *BCL3* encodes a protein that regulates NF- κ B signalling; all are implicated in regulating widespread biological processes as they regulate the expression of a range of genes (Hess *et al.*, 2004; Murray, 2007; Oeckinghaus and Ghosh, 2009; Basso and Dalla-Favera, 2012). *SOCS3* is an inhibitor of the JAK/STAT signalling pathway and is upregulated after leptin stimulation (Section 1.2.3); however, this is the first description of leptin-stimulated *SOCS3* expression in gingival fibroblasts. Therefore, *SOCS3* may be acting to dampen the gingival fibroblast response to leptin (and other cytokines that signal via JAK/STAT molecules). Interestingly, mice deficient in the upstream MAPK signalling mediator *MAP3K8* have a reduced severity of ligature-induced periodontitis (as evidenced by alveolar bone loss) compared to wild-type animals, and *MAP3K8* is required for TNF- α expression in the gingiva (Ohnishi *et al.*, 2010). Further studies investigating the targets of these molecules in leptin-stimulated gingival fibroblasts may help to understand whether they have a functional importance in regulating gingival fibroblast responses during exposure to leptin.

The genes encoding two chemokines (CCL2 and CXCL1) were upregulated by leptin in the genome-wide expression analysis performed in this study. CCL2 and CXCL1 are secreted proteins which bind to the cell surface receptors CCR2 and CXCR2 respectively (Fernandez and Lolis, 2002). This suggests that leptin-stimulated gingival fibroblasts may promote chemokine signalling and responses in CCR2+ and CXCR2+ cells. Chemokines are characterised by their role in promoting leukocyte infiltration into peripheral tissues; for example, CCL2 promotes monocyte infiltration and macrophage migration, while CXCL1 promotes neutrophil chemotaxis (Fernandez and Lolis, 2002). However, chemokines also regulate other processes in inflammation and immunity (e.g. angiogenesis, leukocyte survival and differentiation); for example, CCL2 is implicated in regulating Th2 polarisation and regulatory T cell function (Deshmane *et al.*, 2009). Leukocyte infiltration is an important part of homeostatic tissue immunosurveillance, but increased chemokine levels and leukocyte infiltration are associated with numerous diseases including periodontitis (Silva *et al.*, 2007). Overall, these results suggest that leptin-stimulated gingival fibroblasts promote CCL2 and CXCL1 responses; however, it is unclear whether these responses would be beneficial or pathogenic.

Of note, the chemokines upregulated in the TLDA expression analysis did not correspond to those upregulated in the genome-wide expression analysis in this study. This discrepancy could be due to the different expression analysis technologies used (PCR versus microarray), data generated (expression relative to reference gene versus no reference gene), or differences in experimental design (number of hGF donors tested and concentration of leptin). Therefore, validation of the microarray results for chemokine expression at the mRNA and protein level should be performed before any further studies of chemokines based on the results of this study are performed.

Leptin increased the expression of genes that encode three extracellular immune mediators in hGFs (*IL18BP*, *IL6*, and *IDO*). IL-18 binding protein inhibits the activity of the IL-1 family cytokine IL-18; IL-18 is implicated in promoting Th1-type immune responses (Preshaw and Taylor, 2011). This suggests that leptin-stimulated gingival fibroblasts may dampen Th1-polarised responses in the gingiva. The enzyme IDO converts the essential amino acid tryptophan to kyurenine, thereby reducing tryptophan availability, and is upregulated in gingival fibroblasts stimulated with TLR agonists (Mahanonda *et al.*, 2007). Tryptophan is required for cell metabolism and growth, and therefore in regard to immune function, IDO is implicated in inhibiting both microbe and T cell proliferation (King and Thomas, 2007). This suggests that gingival

fibroblasts may regulate infection and immunity in the gingiva by producing IDO, and that leptin is one mediator that regulates this process. The results of this study confirm the work of Park *et al.* (2013) who found that leptin stimulates the production of the cytokine IL-6 by gingival fibroblasts. IL-6 has pleiotropic functions in regard to inflammation and immunity including stimulating cells to produce inflammatory mediators such as cytokines, chemokines, vasoactive mediators and proteases (Scheller *et al.*, 2011). Also, IL-6 regulates the proliferation, activation and differentiation of numerous cell types, and enhances the production of leukocytes in the bone marrow (Scheller *et al.*, 2011). IL-6 binds to the IL-6 receptor, which is either found on the cell surface or in a soluble form (Mihara *et al.*, 2012). Intracellular signal transduction stimulated by IL-6 requires the formation of a complex consisting of the IL-6 receptor and another cell surface receptor (gp130/IL-6 signal transducer) (Mihara *et al.*, 2012). Interestingly, cells that express only gp130 can still respond to IL-6 if IL-6 is bound to the soluble form of the IL-6 receptor (Scheller *et al.*, 2011). IL-6 is implicated in the pathogenesis of RA as evidenced by reduced disease activity after treatment with an anti-IL-6 monoclonal antibody; however, individuals treated with this antibody had an increased risk of infection, which supports an important role for IL-6 in controlling and clearing infections (Emery *et al.*, 2008). The results in this study demonstrate that fibroblasts are a likely source of IL-6 in the gingiva, and support the hypothesis that gingival fibroblasts regulate inflammation and immunity (Section 1.11). However, it is unclear what the functional outcomes of leptin-stimulated increases in IL-6 production by gingival fibroblasts are, and whether these outcomes would be beneficial or deleterious *in vivo*.

Several of the GO terms overrepresented in leptin-stimulated gingival fibroblasts were relevant to IFN signalling and responses. Two possibilities exist to explain this result: either leptin upregulated the production of IFN- γ at an early time point which had an autocrine effect on hGFs evident at 24 h; alternatively, IFN- γ signalling and responses were highlighted after leptin stimulation because both leptin and IFN- γ activate similar signalling pathways and upregulate a similar profile of genes (Section 1.2) (Schroder *et al.*, 2004; Myers *et al.*, 2008). Further work investigating gene expression at other time points and IFN- γ receptor expression on the surface of gingival fibroblasts would help to address the first possibility.

The results in this study support the existing evidence that IL-1 promotes an inflammatory gingival fibroblast phenotype (Section 1.11). In this study IL-1 stimulated

a higher number of differentially expressed genes in hGFs in comparison to leptin, and the differential level of gene expression for many of the genes whose products have inflammatory function was also higher in hGFs stimulated with IL-1 compared to hGFs stimulated with leptin. For example, *IL6* was expressed at a level in IL-1 stimulated hGFs over 10 times that observed in leptin-stimulated hGFs. This suggests that IL-1 has a stronger stimulatory effect on the inflammatory gingival fibroblast phenotype in comparison to leptin (at least regarding the present experimental design). The finding that IL-1 and leptin+IL-1 stimulated hGFs had more differentially expressed genes in common compared to leptin and leptin+IL-1 stimulated hGFs, suggests that IL-1 has a more dominant effect on hGF phenotype than leptin. Nonetheless, leptin and IL-1 synergistically regulated the expression of several genes in hGFs whose products are implicated in inflammation and ECM remodelling. These results add to the finding that leptin+IL-1 synergistically regulate the production of MMPs by hGFs identified earlier in this study (Chapter 4), and suggest that the actions of leptin and IL-1 on gingival fibroblast phenotype are not limited to ECM remodelling.

hGFs can express a number of chemokines (Section 1.11.3), and at least one chemokine (CXCL10) is synergistically upregulated by hGFs stimulated with IL-1 and OSM (Hosokawa *et al.*, 2010a). In this study leptin and IL-1 synergistically increased the expression of genes that encode chemokines in hGFs (*CXCL5*, *CXCL9*, *CCL7* and *CCL20*). Several other chemokines genes were significantly upregulated in leptin+IL-1 stimulated hGFs but not synergistically regulated by these stimuli (*CXCL8*, *CXCL6*, *CCL8*, *CCL2* and *CXCL1*). As discussed earlier, chemokines are implicated in leukocyte recruitment into tissues but also affect angiogenesis, leukocyte activation and differentiation (Fernandez and Lolis, 2002). This suggests that leptin+IL-1 stimulated hGFs (in comparison to leptin-stimulated hGFs) have a greater ability to stimulate chemokines responses in the gingiva. The chemokines encoded by the genes upregulated in leptin+IL-1 stimulated hGFs are implicated in the chemotaxis of neutrophils (via *CXCL5*, *CXCL1*, *CXCL6*, *CXCL8*), monocytes, basophils and NK cells (via *CCL7*, *CCL2*, *CCL8*), lymphocyte subsets (via *CXCL9*, *CCL7*, *CCL20*, *CCL2*, *CCL8*) and DCs (via *CCL7*, *CCL20*, *CCL8*) (Murphy *et al.*, 2011). Broadly speaking, this suggests that leptin+IL-1 stimulated hGFs may promote the infiltration of all the main circulating leukocyte subsets into the gingiva. Additionally, leptin+IL-1 stimulated hGFs synergistically increased the expression of *CSF2*, which encodes the cytokine granulocyte-macrophage CSF. This implies that hGFs exposed to leptin and

IL-1 not only increase leukocyte infiltration, but also stimulate haematopoiesis of granulocytes and monocytes in the bone marrow. CCL20 only binds one chemokine receptor (CCR6), and this receptor is highly expressed on the Th17 subset of lymphocytes and promotes their transendothelial migration (Grodecki-Pena *et al.*, 2013). This suggests that in the presence of leptin and IL-1 gingival fibroblasts may enhance the recruitment of Th17 cells into the gingiva, which is interesting because Th17 cells are implicated in the pathogenesis of chronic inflammatory diseases including periodontitis (Miossec and Kolls, 2012; de Aquino *et al.*, 2014). Chemokines do not solely act on leukocytes; for example, fibroblast-derived CCL7 enhances the proliferation, invasion and migration of oral squamous carcinoma cells (Jung *et al.*, 2010). Perhaps gingival fibroblasts exposed to leptin and IL-1 enhance gingival epithelial cell proliferation and migration via CCL7, which could play a role in both wound healing and the epithelial proliferation observed in periodontitis. Further studies that identify whether non-cancerous gingival epithelial cells are responsive to CCL7 would help to address this hypothesis.

The expression levels of only two other genes which encode cytokines were synergistically upregulated in hGFs by leptin+IL-1 in this study (*IL6*, *IL24*); however, several other cytokine genes were differentially expressed in leptin+IL-1 stimulated hGFs (*IL32*, *IL33*, *LIF*, *TGFB3*, *CSF3*). This suggests that the cytokine networks active in the gingiva will be altered if gingival fibroblasts are exposed to both leptin and IL-1. The results in this study support the previous finding that the IL-10 family cytokine IL-24 is expressed in oral fibroblasts (Costea *et al.*, 2013). To my knowledge, this is the first study to show that leptin, alone and in synergy with IL-1, increases IL-24 production in any cells. IL-24 is a relatively newly described cytokine, and its functional relevance is still to be fully determined (Wang and Liang, 2005). However, clinical studies have found that increased expression levels of IL-24 are positively associated with chronic inflammatory diseases including IBD and RA (Wang and Liang, 2005; Kragstrup *et al.*, 2008; Andoh *et al.*, 2009). Additionally, IL-24 promotes the production of the pro-inflammatory cytokines IL-6, TNF- α and IFN- γ by peripheral blood mononuclear cells *in vitro* (Caudell *et al.*, 2002). These studies suggest that IL-24 plays a role in inflammatory processes.

Lower expression levels of IL-24 in rat gingiva are detected 7 days after ligature-induced periodontitis is initiated in Zucker (leptin receptor deficient) rats compared to wild-type controls (Soboku *et al.*, 2014). This suggests that the reduced levels of IL-24

observed by Soboku *et al.* (2014) could be due to a lack of leptin signalling, which is in agreement with the results in the current study that leptin(+IL-1) enhances IL-24 production by gingival fibroblasts. However, differential IL-24 expression levels between Zucker and wild-type rats were only detected at the later of the two time points studied. Therefore, the functional relevance of differentially expressed IL-24 in ligature-induced periodontitis in the leptin receptor deficient rat is unclear.

In another study, increased IL-24 expression levels were detected in mucoperiosteal (oral mucosa and periosteum) connective tissue from individuals with refractory compared to stable periodontitis (Kim *et al.*, 2006). In this study, refractory periodontitis was diagnosed if individuals required multiple rounds of treatment for periodontitis, or because they experienced multiple tooth loss after initial treatment for periodontitis. In comparison, individuals who required only maintenance therapy after initial periodontitis treatment were classified as having stable periodontitis. This suggests that IL-24 could play a role in the pathogenesis of refractory periodontitis. Interestingly, two of the other genes highly upregulated in refractory periodontitis connective tissue in this study were *MMP1* and *MMP3* which, along with *IL24*, were synergistically upregulated by leptin and IL-1 in hGFs in the current study. Taken together, these suggest that leptin and IL-1 could drive the gingival fibroblast phenotype towards that of one observed during refractory periodontitis. However, mucoperiosteal connective tissue would have contained multiple cell types, not just gingival fibroblasts. Additionally, no patient information (e.g. sex, BMI, age) was reported in this study beyond not having any significant medical history nor taking medications that might interfere with the study. Leptin levels vary between sex and BMI (Maffei *et al.*, 1995), and therefore, in the study by Kim *et al.* (2006) it is impossible to determine whether differences in leptin levels may have been associated with refractory periodontitis and the observed gene expression profile. Overall, the studies by Soboku *et al.* (2014), Kim *et al.* (2006) and now the current study, suggest that IL-24 is a gingival fibroblast-derived cytokine that is associated with gingival inflammation and periodontitis. It would be interesting to perform further studies to identify which cells in the inflamed gingiva express the IL-24 receptors as a first step to investigate the targets and functions of IL-24 in the inflamed gingiva.

The gene encoding prostaglandin-endoperoxide synthase 2 (PTGS2) (alternatively known as COX-2) is upregulated in IL-1 stimulated hGFs (Båge *et al.*, 2011), and in this study was synergistically upregulated by leptin and IL-1. It is well established that

the intracellular enzyme PTGS2 is upregulated during inflammation. PTGS2 converts the fatty acid arachidonic acid to PGH₂. PGH₂ is subsequently converted into lipid mediators classified as the prostanoids (prostaglandins, thromboxanes and prostacyclins). Between them, the prostanoids have a wide range of pro- and anti-inflammatory functions, and can regulate the production of MMPs (Domeij *et al.*, 2002; Smyth *et al.*, 2009). This suggests that gingival fibroblasts exposed to IL-1 and leptin could regulate inflammatory processes and ECM remodelling in the gingiva by producing prostanoids. Interestingly, only one of the genes (*PTGES*) that encodes an enzyme that converts PGH₂ to a prostanoid was upregulated in leptin+IL-1 stimulated hGFs. *PTGES* encodes PGE synthase and converts PGH₂ to PGE (Smyth *et al.*, 2009). This suggests that gingival fibroblasts exposed to leptin and IL-1 may increase the production of PGE in particular. Immunoassays that detect prostanoids in supernatants from *in vitro* cell cultures are commercially available and could be used to confirm this.

Several genes (*LBP*, *CD14*, *CFB*, *C1R*, and *FAIM3*) whose products are implicated in immune system processes were upregulated by leptin+IL-1 in hGFs in this study. *FAIM3* has been discussed earlier but it was interesting that the mRNA level of this Fc receptor was synergistically upregulated by leptin+IL-1 in this study, suggesting that gingival fibroblasts may be even more sensitive to IgM when exposed to both leptin+IL-1 compared to either stimuli alone. *LBP* which encodes LPS binding protein (LBP) was also synergistically upregulated by IL-1 and leptin in hGFs. At low concentrations LBP promotes cellular responses to LPS by facilitating the interaction of LPS with CD14 and TLR4; at high concentrations LBP appears to be able to neutralise LPS, thereby reducing the threat of endotoxaemia in the circulation or preventing microbial invasion in epithelial tissues (Gutsmann *et al.*, 2001). Interestingly, the gene encoding CD14 was only upregulated in hGFs stimulated with leptin(±IL-1). Therefore, after confirming if CD14 and LBP are altered at the protein level, it would be interesting to determine whether there is any difference in TLR4 signalling in gingival fibroblasts pre-treated with leptin, IL-1 or leptin+IL-1 given the differences in the regulation of CD14 and LBP expression observed between these conditions.

The genome-wide expression analysis performed in this study identified several differentially expressed genes (*MMP1*, *MMP3*, *MMP8*, *MMP12*, *MMP14*, *MMP2*, *PLAT*, *TIMP3*, *COL6A3*, *COL8A2*, *COL5A1*, *COL15A1*, and *COL14A1*) in gingival fibroblasts after leptin+IL-1 treatment whose products are relevant to ECM remodelling. I confirmed that leptin and IL-1 synergistically upregulate the expression of MMP-1

and MMP-3 by gingival fibroblasts as observed earlier in this study (Chapter 4), but also identified that MMP-8 and MMP-12 were similarly synergistically regulated adding to the earlier findings in this study which suggest that leptin and IL-1 promote an ECM-degrading gingival fibroblast phenotype. The results presented in this chapter suggest that under inflammatory conditions leptin substantially enhances gingival fibroblast-mediated collagen remodelling by increasing the production of the collagenases MMP-1 and MMP-8. As discussed previously, the collagenase MMP-8 is thought to play an important role in tissue destruction during periodontitis (Section 3.5). The elastase MMP-12 degrades numerous ECM components, but can also activate other MMPs, including MMP-2 and MMP-3 (Chen, 2004). Interestingly, MMP-12 can activate itself through autolytic processing, which suggests that gingival fibroblast-derived MMP-12 could initiate the activation of other MMPs produced by gingival fibroblasts in the inactive pro-enzyme form.

Significant decreases in the expression levels of several collagen genes (*COL6A3*, *COL8A2*, *COL5A1*, *COL15A1*, and *COL14A1*) were detected in hGFs after leptin+IL-1 stimulation in this study; however, only *COL6A3* was synergistically downregulated by leptin and IL1. *COL6A3* encodes one of the three proteins which form collagen type VI microfibrils. These microfibrils bind both fibrillar collagens and proteoglycans, and are therefore implicated in the organisation of ECMs (Bonnemann, 2011). Collagen type VI is found in the gingiva (Shikata *et al.*, 1993), which together with the current results suggests that gingival fibroblasts are a cellular source of this collagen. The finding that leptin+IL-1 decreased the expression of several collagen genes in hGFs suggests that under proinflammatory and hyperleptinaemic conditions gingival fibroblasts are synthesising less collagen.

Overall, the increased expression of ECM-targeting proteases in combination with the reduced expression of several collagen genes and the lack of change in TIMP expression in gingival fibroblasts after leptin+IL-1 stimulation, suggests that under hyperleptinaemic and pro-inflammatory conditions gingival fibroblasts alter the balance of ECM homeostasis towards ECM degradation.

Interestingly, the RA pathway was one of the most significantly over-represented in leptin, IL-1 and leptin+IL-1-stimulated hGFs. The pathogenesis of RA bears several similarities to periodontitis; fibroblasts are implicated in both diseases, both diseases are positively associated with obesity, and chronic inflammation and excessive ECM

degradation are involved in both diseases (Kornman, 2008; McInnes and Schett, 2011). Periodontitis currently has no unique KEGG pathway and therefore, the RA pathway is probably one of the best matches for periodontitis given the similarities between these conditions.

In conclusion, the genome-wide expression analysis performed in this study demonstrated that leptin changes the expression profile of hGFs, and suggests that these changes may function to regulate immune system processes and inflammatory pathways. In particular these results suggest that leptin enhances the immunocompetence of gingival fibroblasts and may improve immunosurveillance in the gingiva. Additionally, leptin enhanced the potent inflammatory and ECM-degrading phenotype stimulated by IL-1 in hGFs, which suggests that the presence of high concentrations of leptin in the inflamed gingiva may promote a stronger inflammatory response and ECM destruction. This supports the hypothesis that leptin is a mechanistic link underpinning the increased risk of developing periodontitis in conditions associated with hyperleptinaemia.

Several limitations must be addressed regarding the results presented in this chapter. Gene expression at only one time point was assessed in this microarray study. Therefore, genes regulated at other time points by leptin and IL-1 may not have been identified, and this may have affected the interpretation of the gingival fibroblast expression profile after leptin and IL-1 stimulation. Additionally, two decisions used in the analysis of the microarray dataset may have affected the results presented in this chapter. Firstly, to generate data from microarray experiments certain assumptions have to be made. In this study the datasets from the samples of one donor were somewhat different to those of the other two donors (Figure E.2E). It is important, and appropriate, to address this kind of variation in large datasets (Leek and Storey, 2007). The assumption was made that this variation was due to a combination of unknown or non-measurable variation (likely both technical and biological). The surrogate variable analysis is one approach which is used to eliminate this kind of variance between datasets. However, there are other approaches that could have addressed this variation. For example, a paired analysis approach could have been performed. In this approach an assumption could have been made that each of the datasets derived from an individual donor are related, to account for donor-dependent variation yet maintain the statistical power of the experiment. It would be interesting to compare the results of a paired analysis to the surrogate variable analysis performed in this study. Secondly, the

identification of differentially expressed genes used for gene lists, GO and KEGG pathway analysis was based on a raw fold change of 2, and a corrected p value of <0.01. Cut-offs like this are required in microarray analysis, but have the statistical potential to generate false negative or positive results. For example, in this study leptin-stimulated MMP-1 expression in hGFs was not significantly upregulated in the microarray analysis, in contrast to the real-time RT-PCR analysis. Nonetheless, the focus of this study was to identify strongly differentially expressed genes in hGFs, particularly those regulated by leptin and IL-1 in synergy. Therefore, a stringent p-value cut-off was selected to eliminate false positives. Finally, the microarray only identified gene expression levels in gingival fibroblasts and further work would be required (as was performed for IL-24 in this study) to determine whether these differential expression levels related to protein levels. Additionally, it is not possible to determine how the observed changes in hGF phenotype are relevant to function in the gingiva; *in vivo*, *ex vivo*, or 3D models of normal or inflamed gingival tissue would be required to address this. For this reason, a gingival tissue explant model was developed and the results of this work are presented in Chapter 7.

Table 6.1: Expression levels of genes on the immune TLDA in leptin-stimulated hGFs.

hGFs were stimulated with 1 µg/ml leptin for 24 h or left unstimulated as a control. Cells were lysed and cDNA was prepared by reverse transcription. cDNA was loaded onto a human immune panel TLDA and gene expression was determined by real-time RT-PCR. Relative gene expression was determined using the 2^{-ddCt} method by using 18S rRNA as the reference gene. Data (n=1) are shown as fold unstimulated control. Genes with >2-fold change in gene expression are highlighted in bold. ND – not detected in leptin or unstimulated hGFs, + - only detected in leptin-stimulated hGFs.

Gene	Leptin (fold control)	Gene	Leptin (fold control)	Gene	Leptin (fold control)
CXCL10	8.19	IL6	8.04	CD80	+
CXCL8	4.82	IL15	4.93	CD8A	3.57
CCL5	2.60	IL12A	3.12	CD40	1.37
STAT3	2.44	IL7	2.65	CD68	1.36
NFKB2	1.97	IL18	2.11	CD38	1.28
CXCL11	1.92	IL1A	ND	CD4	1.19
CCL2	1.78	IL1B	ND	CD19	ND
CSF1	1.60	IL2	ND	CD28	ND
IKBKB	1.31	IL2RA	ND	CD3E	ND
CCR4	1.14	IL3	ND	CD40LG	ND
CCL3	ND	IL4	ND	CD86	ND
CCL19	ND	IL5	ND	CTLA4	ND
CCR2	ND	IL9	ND		
CCR5	ND	IL10	ND		
CSF2	ND	IL12B	ND		
CSF3	ND	IL-13	ND		
CXCR3	ND	IL-17	ND		

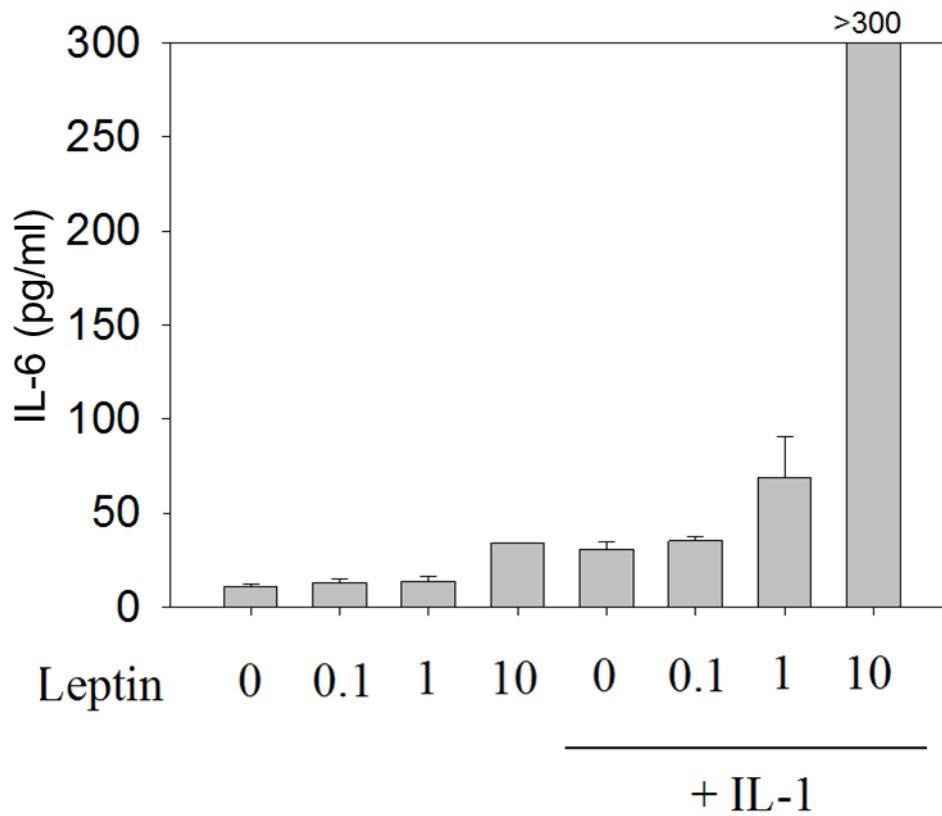

Figure 6.1: IL-6 secretion by hGFs after stimulation with leptin and IL-1

hGFs from one donor were either unstimulated or stimulated with leptin (0.1, 1, 10 μg/ml), IL-1α (0.05 ng/ml) or leptin+IL-1α (leptin 0.1, 1, 10 μg/ml, IL-1α 0.05 ng/ml) for 24 h. Supernatants were collected and IL-6 concentrations were assessed by ELISA. Data (ng/ml) are shown as mean+SD (n=2). Leptin (10 μg/ml) +IL-1α was above the top standard (300 ng/ml).

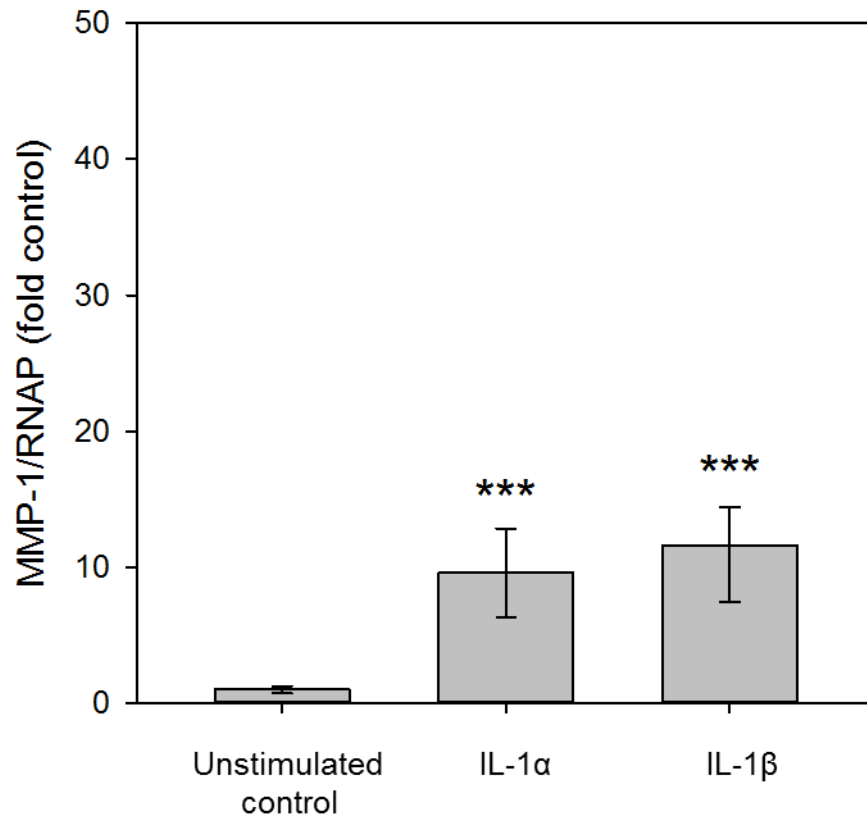

Figure 6.2: MMP-1 gene expression in hGFs after stimulation with IL-1 α and IL-1 β .

hGFs were stimulated with IL-1 α (0.05 ng/ml) or IL-1 β (0.05 ng/ml) for 24 h. Cells were lysed and cDNA was prepared by reverse transcription. Real-time RT-PCR was used to assess MMP-1 and RNAP gene expression. Relative MMP-1 gene expression was determined using the $2^{-\Delta\Delta C_t}$ method by using RNAP as the reference gene. Data are shown as median+IQR (n=20) from two donors stimulated in independent experiments. Statistics: Mann-Whitney U test for independent samples (Bonferroni-corrected) ***=p<0.001 compared to unstimulated control.

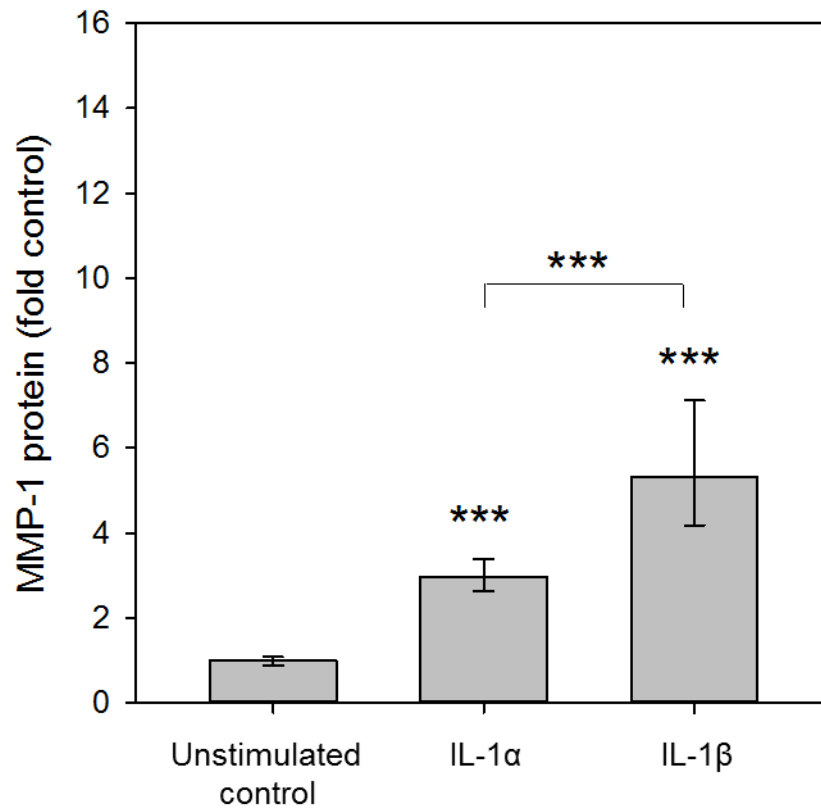

Figure 6.3: MMP-1 protein secretion by hGFs after stimulation with IL-1 α and IL-1 β .

hGFs were stimulated with IL-1 α (0.05 ng/ml) or IL-1 β (0.05 ng/ml) for 24 h. Supernatants were collected and MMP-1 concentrations were assessed by ELISA. Data (fold unstimulated control) are shown as median+IQR (n=15-16) from two donors stimulated in independent experiments. Statistics: Mann-Whitney U test for independent samples (Bonferroni-corrected) ***=p<0.001 compared to unstimulated control unless otherwise indicated.

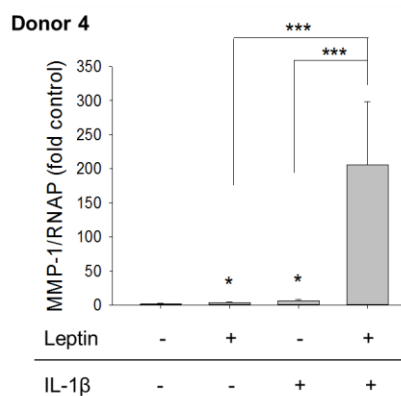
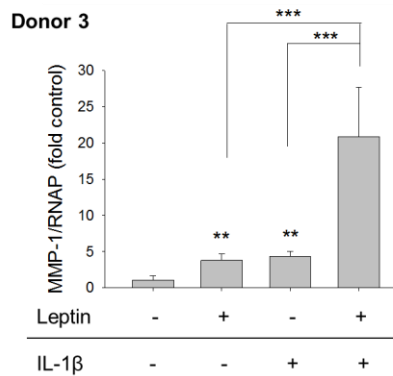
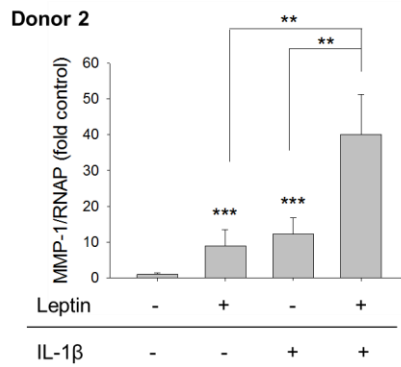

Figure 6.4: MMP-1 gene expression in hGFs after stimulation with leptin and IL-1β.

hGFs from three donors were stimulated with leptin (10 μg/ml), IL-1β (0.05 ng/ml) or leptin+IL-1β (leptin 10 μg/ml, IL-1β 0.05 ng/ml) for 24 h in independent experiments (96-well format). Cells were lysed and cDNA was prepared by reverse transcription. Real-time RT-PCR was used to assess MMP-1 and RNAP gene expression. Relative MMP-1 gene expression was determined using the $2^{-\text{ddCt}}$ method by using RNAP as the reference gene. Data (fold unstimulated control) on each graph are shown as mean+SD (n=4) from one donor as indicated. Statistics: T test or Mann-Whitney U test for independent samples (Bonferroni-corrected) *=p<0.05, **=p<0.01, ***=p<0.001 compared to unstimulated control unless otherwise indicated.

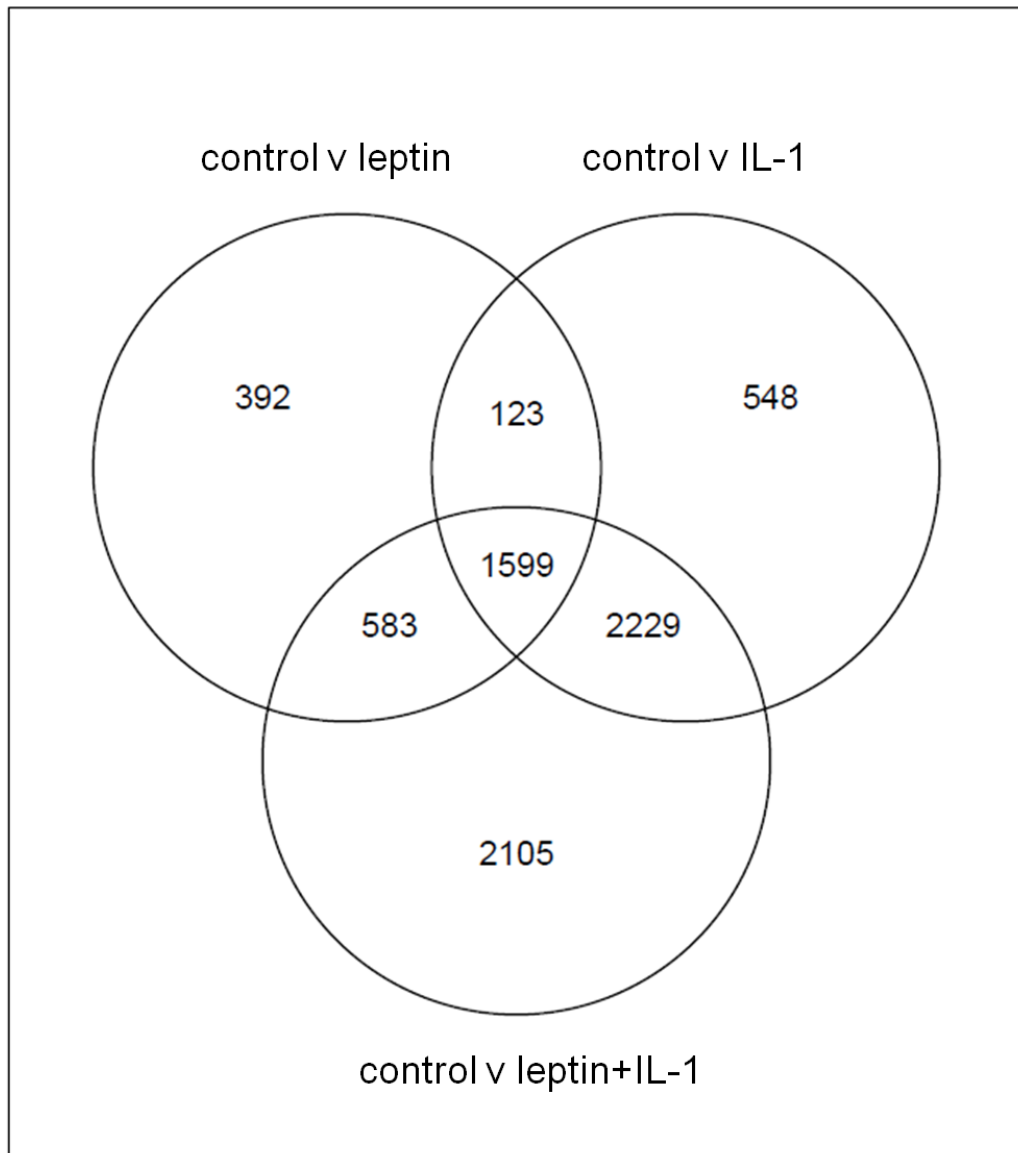

Figure 6.5: Venn diagram displaying the relationship between differentially expressed genes in hGFs after stimulation with leptin, IL-1 or leptin+IL-1

hGFs from three donors were stimulated with leptin (10 $\mu\text{g/ml}$), IL-1 β (0.05 ng/ml) or leptin+IL-1 β (leptin 10 $\mu\text{g/ml}$, IL-1 β 0.05 ng/ml) for 24 h in independent experiments (6-well format). Cells were lysed and RNA extracted. The 12 samples generated were used for genome-wide expression analysis (Illumina human Ht12 v4 beadchip). The microarray datasets were subject to bioinformatics analysis. Using the corrected dataset differentially expressed gene lists were generated for the comparisons control v leptin, control v IL1, control v leptin+IL-1 using an adjusted p-value cut off of 0.01, but no fold change cut-off. This Venn diagram displays the number of differentially expressed genes common or unique to the different treatment conditions.

Table 6.2: Selection of differentially expressed genes in hGFs after leptin stimulation

hGFs from three donors were stimulated with leptin (10 µg/ml) for 24 h in independent experiments (6-well format). Cells were lysed and RNA extracted. RNA was used for genome-wide expression analysis (Illumina human Ht12 v4 beadchip). The microarray datasets were used for bioinformatics analysis. Using the corrected dataset a differentially expressed gene list was generated for the comparison unstimulated control v leptin (Section 2.8.2). 111 genes were differentially expressed; 20 genes relevant to inflammation, immunity, cell proliferation, leptin signalling and ECM homeostasis are displayed in this table. For each gene the full gene name, fold change and adjusted p-value are displayed. Downregulated genes are shaded in grey. CLL – chronic lymphocytic leukaemia, ADAM – a disintegrin and metalloproteinase.

Symbol	Gene name	Fold change	p-value
CCL2	chemokine (C-C motif) ligand 2	7.98	1.1E-05
IL18BP	interleukin 18 binding protein	7.70	6.6E-06
IL6	interleukin 6 (interferon, beta 2)	3.74	1.3E-03
CTSL	cathepsin L	3.63	1.4E-06
BCL3	B-cell CLL/lymphoma 3	2.87	1.2E-07
MAP3K8	mitogen-activated protein kinase kinase kinase 8	2.79	2.0E-05
CD14	CD14 molecule	2.77	9.8E-03
HLA-DRA	major histocompatibility complex, class II, DR alpha	2.75	2.6E-04
BCL6	B-cell CLL/lymphoma 6	2.72	1.1E-06
STAT1	signal transducer and activator of transcription 1, 91kDa	2.69	4.5E-03
IL13RA1	interleukin 13 receptor, alpha 1	2.69	7.7E-07
CXCL1	chemokine (C-X-C motif) ligand 1 (melanoma growth stimulating activity, alpha)	2.58	7.5E-03
FAIM3	Fas apoptotic inhibitory molecule 3	2.54	5.9E-05
HLA-DMA	major histocompatibility complex, class II, DM alpha	2.50	1.1E-04
IDO1	indoleamine 2,3-dioxygenase 1	2.44	3.6E-04
IL1R1	interleukin 1 receptor, type I	2.26	6.5E-07
ADAMTS1	ADAM metalloproteinase with thrombospondin type 1 motif, 1	2.23	7.8E-05
SOCS3	suppressor of cytokine signalling 3	2.17	1.8E-06
ATF3	activating transcription factor 3	2.15	4.4E-05
ADAM19	ADAM metalloproteinase domain 19	-2.10	8.9E-05

Table 6.3: Selected GO term processes significantly overrepresented in hGFs after leptin treatment.

hGFs from three donors were stimulated with leptin (10 µg/ml) for 24 h in independent experiments (6-well format). Cells were lysed and RNA extracted. RNA was used for genome-wide expression analysis (Illumina human Ht12 v4 beadchip). The microarray datasets were used for bioinformatics analysis. Using the corrected dataset a differentially expressed gene list was generated for the comparison unstimulated control v leptin (Section 2.8.2). GO analysis was performed and the most significant processes (10 of 44 with $p < 0.001$) (as indicated by adjusted p-value) are displayed in this table.

Name	Process	p-value
GO:0034097	response to cytokine stimulus	4.43E-07
GO:0002376	immune system process	4.43E-07
GO:0034341	response to interferon-gamma	2.70E-06
GO:0071345	cellular response to cytokine stimulus	2.70E-06
GO:0006952	defence response	5.69E-06
GO:0006955	immune response	7.31E-06
GO:0050865	regulation of cell activation	8.87E-06
GO:0019221	cytokine-mediated signalling pathway	1.42E-05
GO:0050863	regulation of T cell activation	1.42E-05
GO:0060337	type I interferon-mediated signalling pathway	1.42E-05

Table 6.4: KEGG pathways significantly overrepresented in hGFs after leptin treatment.

hGFs from three donors were stimulated with leptin (10 µg/ml) for 24 h in independent experiments (6-well format). Cells were lysed and RNA extracted. RNA was used for whole-wide genome expression analysis (Illumina human Ht12 v4 beadchip). The microarray datasets were used for bioinformatics analysis. Using the corrected dataset a differentially expressed gene list was generated for the comparison unstimulated control v leptin (Section 2.8.2). KEGG pathway analysis was performed and the significant pathways identified ($p < 0.01$) are displayed in this table.

Pathway	p-value
Rheumatoid arthritis	4.1E-05
Cytokine:cytokine receptor interaction	7.0E-04
Graft-versus-host disease	8.8E-04
Haematopoietic cell lineage	1.5E-03
Intestinal immune network for IgA production	1.6E-03
JAK-STAT signalling pathway	3.4E-03
Tryptophan metabolism	3.6E-03
Hepatitis C	4.8E-03
Primary bile acid biosynthesis	6.0E-03
Asthma	7.1E-03
TLR signalling pathway	7.7E-03
Amoebiasis	8.1E-03
Cell adhesion molecules	9.7E-03

Table 6.5: Selection of differentially expressed genes in hGFs after IL-1 stimulation

hGFs from three donors were stimulated with IL-1 (0.05 ng/ml) for 24 h in independent experiments (6-well format). Cells were lysed and RNA extracted. RNA was used for genome-wide expression analysis (Illumina human Ht12 v4 beadchip). The microarray datasets were used for bioinformatics analysis. Using the corrected dataset a differentially expressed gene list was generated for the comparison unstimulated control v IL-1 (Section 2.8.2). 263 genes were differentially expressed; 20 genes relevant to inflammation, immunity, and ECM homeostasis are displayed in this table. For each gene the full gene name, fold change and adjusted p-value are displayed. Downregulated genes are shaded in grey. CLL – chronic lymphocytic leukaemia, ADAM – a disintegrin and metalloproteinase.

Symbol	Gene name	Fold change	p-value
IL8	interleukin 8	146	9.1E-07
IL6	interleukin 6 (interferon, beta 2)	69.6	1.0E-07
CXCL6	chemokine (C-X-C motif) ligand 6	65.4	6.1E-08
CXCL1	chemokine (C-X-C motif) ligand 1 (melanoma growth stimulating activity, alpha)	52.8	1.0E-07
CCL2	chemokine (C-C motif) ligand 2	42.4	5.2E-08
CFB	complement factor B	14.0	1.0E-05
MMP3	matrix metalloproteinase 3 (stromelysin 1, progelatinase)	12.1	1.0E-04
CXCL2	chemokine (C-X-C motif) ligand 2	10.9	1.3E-07
CXCL5	chemokine (C-X-C motif) ligand 5	7.74	2.3E-07
CCL7	chemokine (C-C motif) ligand 7	6.86	2.1E-06
CCL8	chemokine (C-C motif) ligand 8	6.60	1.0E-05
PTGES	prostaglandin E synthase	6.43	3.0E-06
CCL20	chemokine (C-C motif) ligand 20	5.95	2.3E-05
IL1RN	interleukin 1 receptor antagonist	4.46	2.3E-07
MMP1	matrix metalloproteinase 1 (interstitial collagenase)	4.32	8.6E-04
IL32	interleukin 32	3.20	3.5E-05
COL8A1	collagen, type VIII, alpha 1	2.71	6.9E-05
IL33	interleukin 33	2.14	9.1E-05
BCL6	B-cell CLL/lymphoma 6	2.09	5.2E-06
ADAM19	ADAM metalloproteinase domain 19	-2.61	5.9E-06

Table 6.6: Selected GO term processes significantly overrepresented in hGFs after IL-1 treatment.

hGFs from three donors were stimulated with IL-1 (0.05 ng/ml) for 24 h in independent experiments (6-well format). Cells were lysed and RNA extracted. RNA was used for genome-wide expression analysis (Illumina human Ht12 v4 beadchip). The microarray datasets were used for bioinformatics analysis. Using the corrected dataset a differentially expressed gene list was generated for the comparison unstimulated control v IL-1 (Section 2.8.2). GO analysis was performed and the most significant processes (10 of 153 with $p < 0.001$) (as indicated by adjusted p-value) are displayed in this table.

Name	Process	p-value
GO:0006952	defence response	8.65E-17
GO:0051707	response to other organism	5.76E-14
GO:0006954	inflammatory response	7.28E-14
GO:0009607	response to biotic stimulus	1.24E-13
GO:0042221	response to chemical stimulus	8.71E-13
GO:0009611	response to wounding	1.61E-12
GO:0002376	immune system process	1.91E-12
GO:0006955	immune response	9.80E-11
GO:0009605	response to external stimulus	1.08E-10
GO:0050896	response to stimulus	1.24E-10

Table 6.7: KEGG pathways significantly overrepresented in hGFs after IL-1 treatment.

hGFs from three donors were stimulated with IL-1 (0.05 ng/ml) for 24 h in independent experiments (6-well format). Cells were lysed and RNA extracted. RNA was used for genome-wide expression analysis (Illumina human Ht12 v4 beadchip). The microarray datasets were used for bioinformatics analysis. Using the corrected dataset a differentially expressed gene list was generated for the comparison unstimulated control v IL-1 (Section 2.8.2). KEGG pathway analysis was performed and the significant pathways identified ($p < 0.01$) are displayed in this table.

Pathway	p-value
NOD-like receptor signalling pathway	4.20E-07
Rheumatoid arthritis	8.10E-07
Cytokine:cytokine receptor interaction	8.30E-06
Chemokine signalling pathway	1.10E-05
Steroid hormone biosynthesis	1.80E-03
Hepatitis C	2.50E-03
RIG-1-like receptor signalling pathway	3.70E-03
TLR signalling pathway	4.50E-03
Cytosolic DNA-sensing pathway	5.20E-03
Cell adhesion molecules	6.40E-03

Table 6.8: Selection of differentially expressed genes in hGFs after leptin+IL-1 stimulation

hGFs from three donors were stimulated with leptin+IL-1 (leptin 10 $\mu\text{g/ml}$, IL-1 0.05 ng/ml) for 24 h in independent experiments (6-well format). Cells were lysed and RNA extracted. RNA was used for genome-wide expression analysis (Illumina human Ht12 v4 beadchip). The microarray datasets were used for bioinformatics analysis. Using the corrected dataset a differentially expressed gene list was generated for the comparison unstimulated control v leptin+IL-1 (Section 2.8.2). 637 genes were differentially expressed; 39 genes relevant to inflammation, immunity, and ECM homeostasis are displayed in this table. For each gene the full gene name, fold change and adjusted p-value are displayed. Downregulated genes are shaded in grey. TIMP – tissue inhibitor of metalloproteinase.

Symbol	Gene name	Fold change	p-value
IL8	interleukin 8	167	1.4E-07
IL6	interleukin 6 (interferon, beta 2)	115	7.7E-09
CXCL6	chemokine (C-X-C motif) ligand 6	96.9	5.9E-09
MMP3	matrix metalloproteinase 3 (stromelysin 1, progelatinase)	55.9	5.8E-07
CCL2	chemokine (C-C motif) ligand 2	54.2	6.1E-09
CXCL1	chemokine (C-X-C motif) ligand 1 (melanoma growth stimulating activity, alpha)	51.2	1.8E-08
IL24	interleukin 24	46.3	7.5E-10
CXCL5	chemokine (C-X-C motif) ligand 5	30.6	1.1E-09
CFB	complement factor B	29.0	3.3E-07
CCL7	chemokine (C-C motif) ligand 7	20.9	1.1E-08
CCL20	chemokine (C-C motif) ligand 20	20.3	7.5E-08
MMP1	matrix metalloproteinase 1 (interstitial collagenase)	13.0	3.3E-06
CCL8	chemokine (C-C motif) ligand 8	12.5	2.1E-07
PTGES	prostaglandin E synthase	10.1	9.1E-08
CXCL2	chemokine (C-X-C motif) ligand 2	9.07	3.8E-08
IL32	interleukin 32	4.07	2.0E-06
IL18BP	interleukin 18 binding protein	3.87	2.1E-05
CSF2	colony stimulating factor 2 (granulocyte-macrophage)	3.66	1.3E-08
CTSL	cathepsin L	3.31	2.0E-07
OSMR	oncostatin M receptor	3.28	1.9E-08
IL33	interleukin 33	2.99	1.4E-06
IL1R1	interleukin 1 receptor, type I	2.95	4.9E-09
IL1RN	interleukin 1 receptor antagonist	2.88	8.0E-07
CSF3	colony stimulating factor 3 (granulocyte)	2.80	5.1E-06
C1R	complement component 1, r subcomponent	2.68	5.8E-06
CXCL9	chemokine (C-X-C motif) ligand 9	2.65	2.5E-08
LIF	leukaemia inhibitory factor	2.61	2.5E-05
PLAT	plasminogen activator, tissue	2.59	4.6E-05
MMP8	matrix metalloproteinase 8 (neutrophil collagenase)	2.45	1.4E-06
MMP2	matrix metalloproteinase 2 (gelatinase A, 72kDa gelatinase, 72kDa type IV collagenase)	2.43	2.2E-06
C1S	complement component 1, s subcomponent	2.41	1.6E-06
IL6ST	interleukin 6 signal transducer (gp130, oncostatin M receptor)	2.30	1.2E-06
MMP14	matrix metalloproteinase 14 (membrane-inserted)	2.03	7.5E-07
MMP12	matrix metalloproteinase 12 (macrophage elastase)	2.00	7.4E-04
COL8A2	collagen, type VIII, alpha 2	-2.02	9.7E-06
COL5A1	collagen, type V, alpha 1	-2.02	8.5E-08
COL15A1	collagen, type XV, alpha 1	-2.05	6.8E-06
COL14A1	collagen, type XIV, alpha 1	-2.18	2.4E-06
TGFB3	transforming growth factor, beta 3	-2.18	4.2E-07
TIMP3	TIMP metalloproteinase inhibitor 3	-2.28	1.1E-03
COL6A3	collagen, type VI, alpha 3	-2.80	4.3E-04

Table 6.9: Selected GO term processes significantly overrepresented in hGFs after leptin+IL-1 treatment.

hGFs from three donors were stimulated with leptin+IL-1 (leptin 10 μ g/ml, IL-1 0.05 ng/ml) for 24 h in independent experiments (6-well format). Cells were lysed and RNA extracted. RNA was used for genome-wide expression analysis (Illumina human Ht12 v4 beadchip). The microarray datasets were used for bioinformatics analysis. Using the corrected dataset a differentially expressed gene list was generated for the comparison unstimulated control v lep+IL-1 (Section 2.8.2). GO analysis was performed and the most significant processes (10 of 255 with $p < 0.001$) (as indicated by adjusted p-value) are displayed in this table.

Name	Process	p-value
GO:0009611	response to wounding	7.66E-18
GO:0048513	organ development	7.97E-16
GO:0042221	response to chemical stimulus	7.97E-16
GO:0006954	inflammatory response	7.97E-16
GO:0048731	system development	7.97E-16
GO:0044707	single-multicellular organism process	5.48E-15
GO:0002376	immune system process	5.48E-15
GO:0032501	multicellular organismal process	2.08E-14
GO:0050896	response to stimulus	7.00E-14
GO:0048856	anatomical structure development	3.04E-13

Table 6.10: KEGG pathways significantly overrepresented in hGFs after leptin+IL-1 treatment.

hGFs from three donors were stimulated with leptin+IL-1 (leptin 10 µg/ml, IL-1 0.05 ng/ml) for 24 h in independent experiments (6-well format). Cells were lysed and RNA extracted. RNA was used for genome-wide expression analysis (Illumina human Ht12 v4 beadchip). The microarray datasets were used for bioinformatics analysis. Using the corrected dataset a differentially expressed gene list was generated for the comparison unstimulated control v leptin+IL-1 (Section 2.8.2). KEGG pathway analysis was performed and the significant pathways identified ($p < 0.01$) are displayed in this table.

Pathway	p-value
Cytokine:cytokine receptor interaction	1.90E-09
Rheumatoid arthritis	7.10E-07
JAK-STAT signalling pathway	1.30E-06
Amoebiasis	4.70E-05
Haematopoietic cell lineage	2.50E-05
Malaria	1.50E-04
Metabolism of xenobiotics by cytochrome P450	1.50E-04
NOD-like receptor signalling pathway	4.90E-04
ECM-receptor interaction	2.10E-03
Chemokine signalling pathway	2.60E-03
Drug metabolism - cytochrome P450	4.80E-03
Histidine metabolism	5.60E-03
Complement and coagulation cascades	7.80E-03
Tryptophan metabolism	8.70E-03
Glycolysis/Gluconeogenesis	8.80E-03
Bladder cancer	9.10E-03
Pathways in cancer	9.90E-03

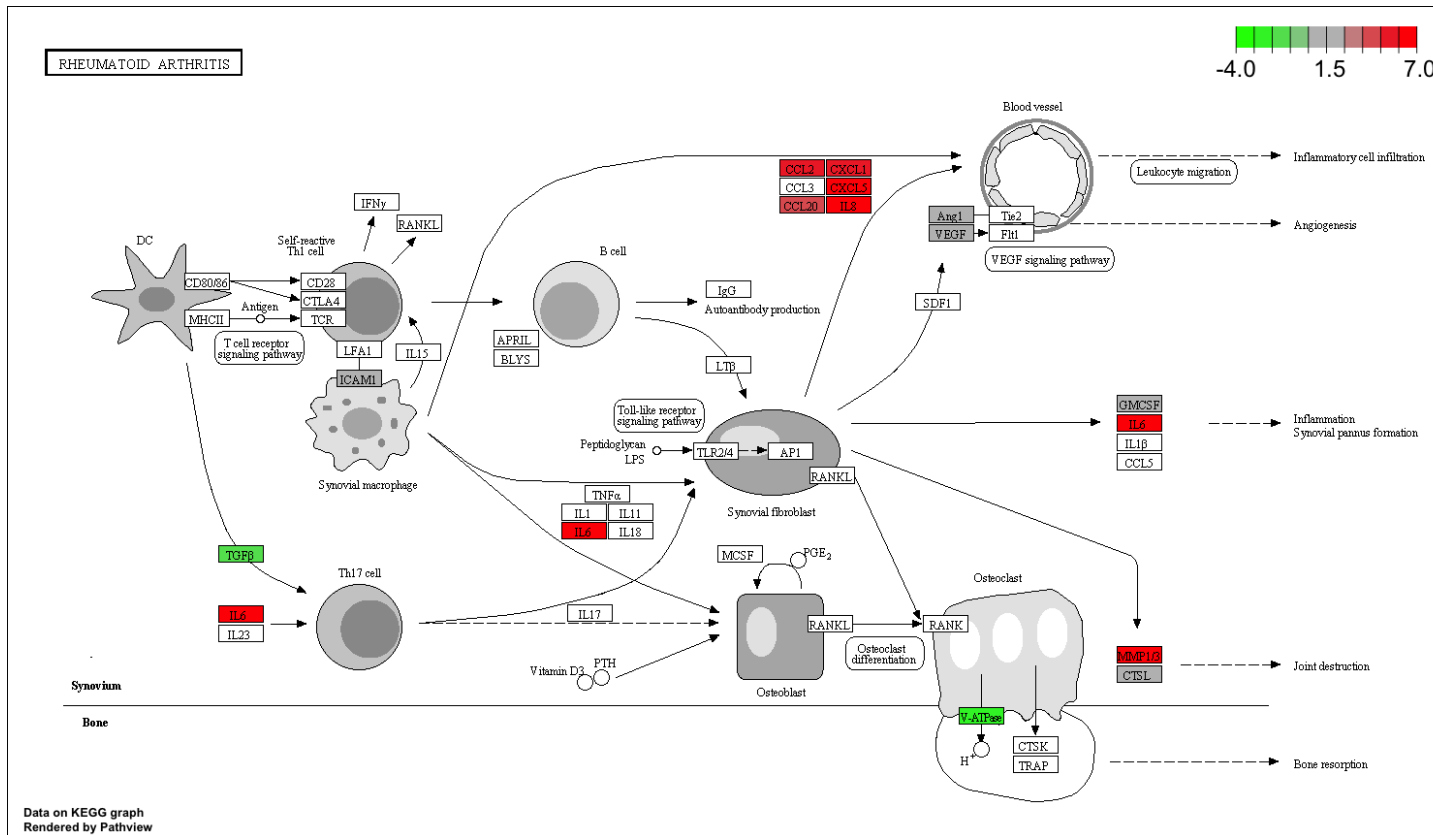

Figure 6.6: Leptin+IL-1 stimulated differentially expressed genes in hGFs represented on the RA KEGG pathway.

hGFs from three donors were stimulated with leptin+IL-1 (leptin 10 µg/ml, IL-1 0.05 ng/ml) for 24 h in independent experiments (6-well format). Cells were lysed and RNA extracted. RNA was used for genome-wide expression analysis (Illumina human Ht12 v4 beadchip). The microarray datasets were used for bioinformatics analysis. Using the corrected dataset a differentially expressed gene list was generated for the comparison unstimulated control v leptin+IL-1 (Section 2.8.2). KEGG pathway analysis was performed on this gene list. This schematic diagram displays the RA KEGG pathway and highlights where gene products are functionally implicated. Differentially expressed genes in the leptin+IL-1 gene list were overrepresented on this pathway as indicated by colour (green/grey/red). Genes coloured green were downregulated, genes coloured grey were upregulated at a low level, and genes coloured red were upregulated at a high level by leptin+IL-1 treatment.

Table 6.11: Selected differentially expressed genes in hGFs potentially synergistically regulated by leptin+IL-1

hGFs from three donors were stimulated with leptin (10 $\mu\text{g/ml}$), IL-1 β (0.05 ng/ml) or leptin+IL-1 β (leptin 10 $\mu\text{g/ml}$, IL-1 β 0.05 ng/ml) for 24 h in independent experiments (6-well format). Cells were lysed and RNA extracted. RNA was used for genome-wide expression analysis (Illumina human Ht12 v4 beadchip). The microarray datasets were used for bioinformatics analysis. Using the corrected dataset differentially expressed gene lists were generated for the comparisons unstimulated control v leptin, unstimulated control v IL-1, unstimulated control v leptin+IL-1, leptin v leptin+IL-1 and IL-1 v leptin+IL-1 (Section 2.8.2). 42 genes relevant to inflammation, immunity, and ECM homeostasis are displayed in this table. For each gene the full gene name and the fold changes in gene expression after leptin, IL-1 and leptin+IL-1 stimulation are displayed. Genes highlighted in bold (and shaded grey) were significantly differentially expressed in the leptin v leptin+IL-1 and IL-1 v leptin+IL-1 gene lists indicating a significant synergistic relationship. ND – not detected (no differential gene expression was detected) TIMP – tissue inhibitor of metalloproteinase, TRAF – TNF receptor-associated factor.

Symbol	Gene name	Fold change (leptin+IL-1)	Fold change (leptin)	Fold change (IL-1)
IL8	interleukin 8	166.74	ND	146
IL6	interleukin 6 (interferon, beta 2)	115.04	3.74	69.6
CXCL6	chemokine (C-X-C motif) ligand 6	96.90	ND	65.4
MMP3	matrix metalloproteinase 3 (stromelysin 1, progelatinase)	55.86	ND	12.1
CCL2	chemokine (C-C motif) ligand 2	54.22	7.98	42.4
IL24	interleukin 24	46.30	ND	ND
CXCL5	chemokine (C-X-C motif) ligand 5	30.64	ND	7.74
CFB	complement factor B	28.97	ND	14.0
CCL7	chemokine (C-C motif) ligand 7	20.90	ND	6.86
CCL20	chemokine (C-C motif) ligand 20	20.30	ND	5.95
PTGS2	prostaglandin-endoperoxide synthase 2	19.43	ND	6.50
MMP1	matrix metalloproteinase 1 (interstitial collagenase)	13.01	ND	4.32
LBP	lipopolysaccharide binding protein	12.91	ND	ND
CCL8	chemokine (C-C motif) ligand 8	12.52	ND	6.60
PTGES	prostaglandin E synthase	10.06	ND	6.43
FAIM3	Fas apoptotic inhibitory molecule 3	5.70	2.54	2.31
CD14	CD14 molecule	5.39	2.77	ND
IL32	interleukin 32	4.07	ND	3.20
CSF2	colony stimulating factor 2 (granulocyte-macrophage)	3.66	ND	ND
OSMR	oncostatin M receptor	3.28	ND	ND
JAK2	Janus kinase 2	3.05	ND	ND
IL33	interleukin 33	2.99	ND	2.14
SOCS3	suppressor of cytokine signalling 3	2.97	2.16	ND
IL1R1	interleukin 1 receptor, type I	2.95	2.27	ND
CSF3	colony stimulating factor 3 (granulocyte)	2.80	ND	ND
VEGFA	vascular endothelial growth factor A	2.75	ND	ND
C1R	complement component 1, r subcomponent	2.68	ND	ND
CXCL9	chemokine (C-X-C motif) ligand 9	2.65	ND	ND
LIF	leukaemia inhibitory factor	2.61	ND	ND
PLAT	plasminogen activator, tissue	2.59	ND	ND
MMP8	matrix metalloproteinase 8 (neutrophil collagenase)	2.45	ND	ND
MMP2	matrix metalloproteinase 2	2.43	ND	ND
IL6ST	interleukin 6 signal transducer (gp130, oncostatin M receptor)	2.30	ND	ND
MMP14	matrix metalloproteinase 14 (membrane inserted)	2.03	ND	ND
MMP12	matrix metalloproteinase 12 (macrophage elastase)	2.00	ND	ND
COL8A2	collagen, type VIII, alpha 2	-2.02	ND	ND
COL5A1	collagen, type V, alpha 1	-2.02	ND	ND
COL15A1	collagen, type XV, alpha 1	-2.05	ND	ND
COL14A1	collagen, type XIV, alpha 1	-2.18	ND	ND
TGFB3	transforming growth factor, beta 3	-2.18	ND	ND
TIMP3	TIMP metalloproteinase inhibitor 3	-2.28	ND	ND
COL6A3	collagen, type VI, alpha 3	-2.80	ND	ND

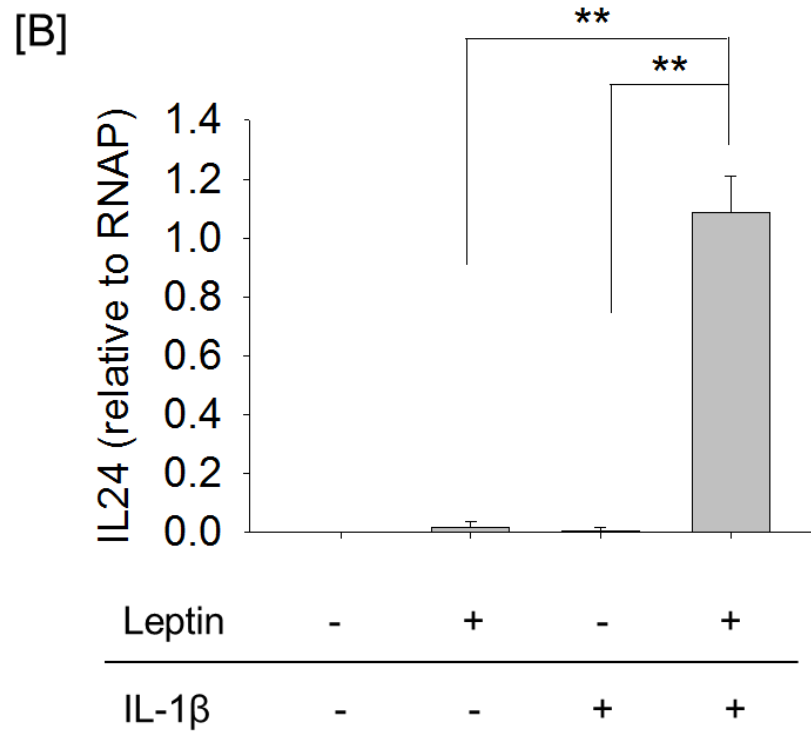
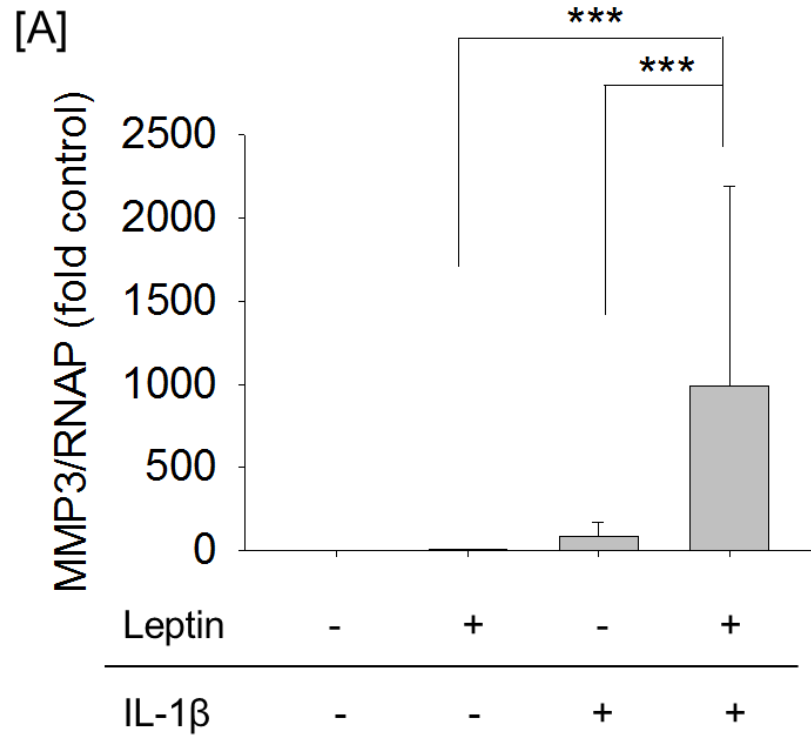

[C]

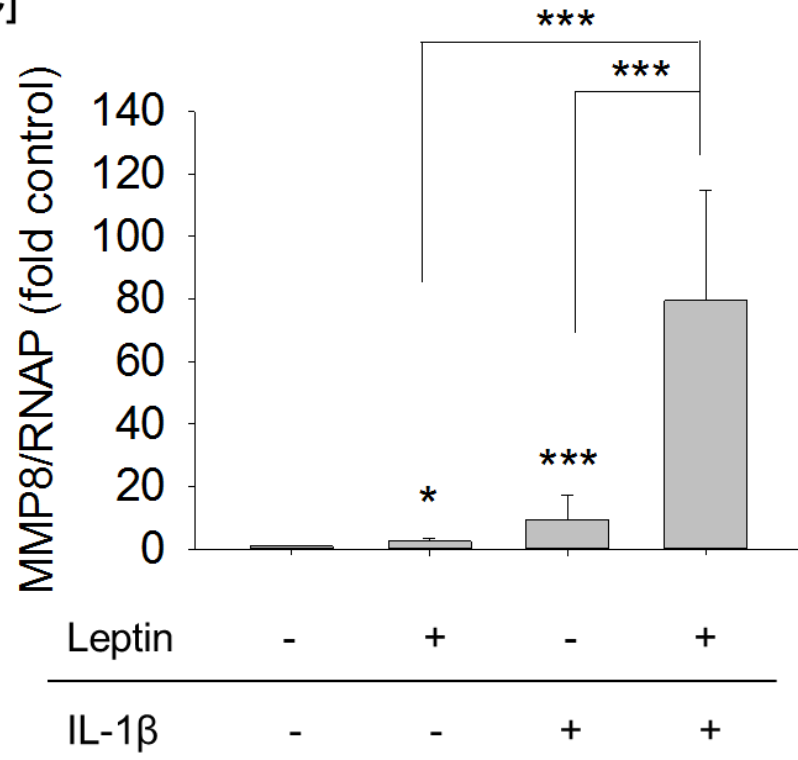

[D]

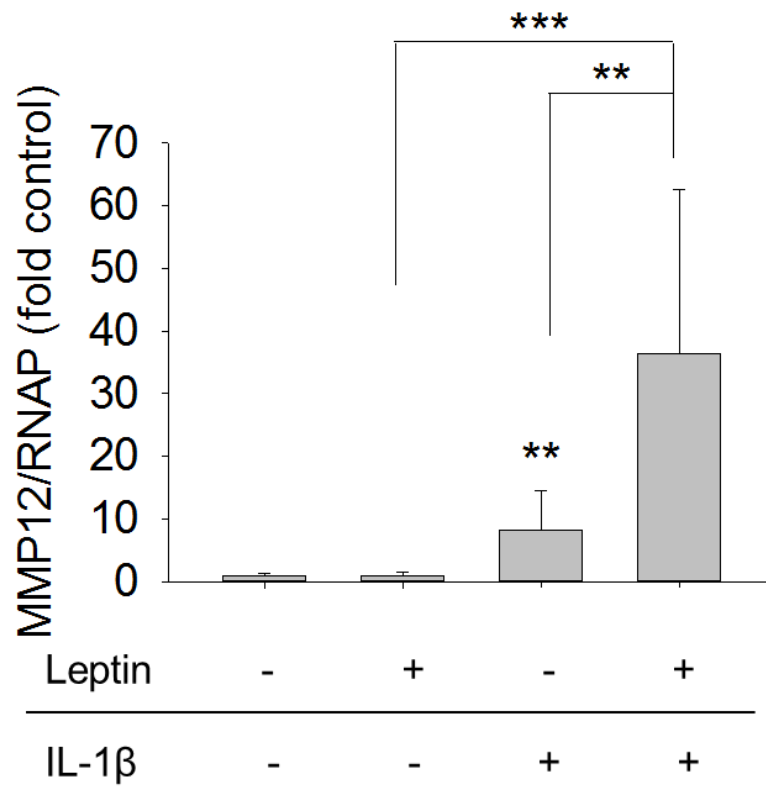

[E]

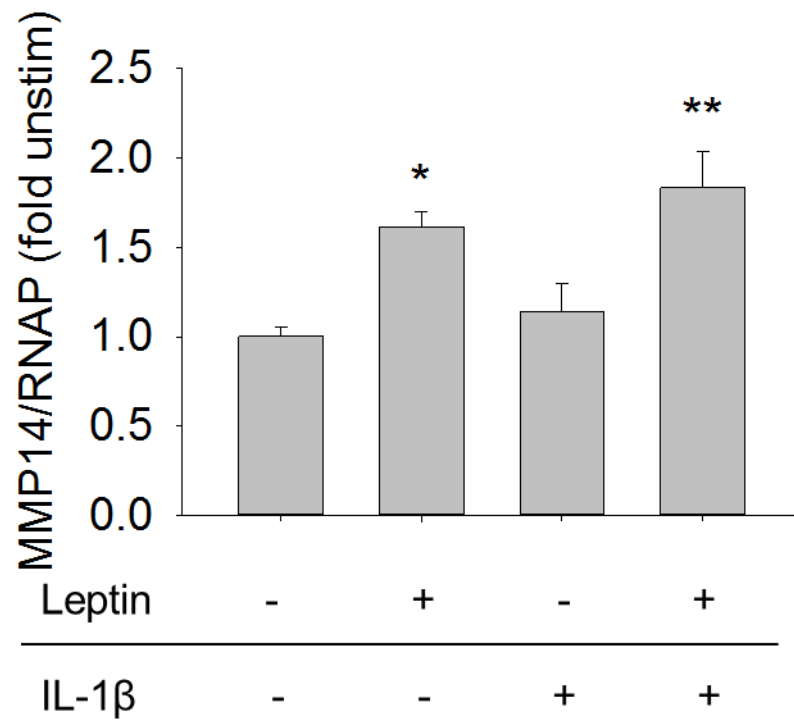

[F]

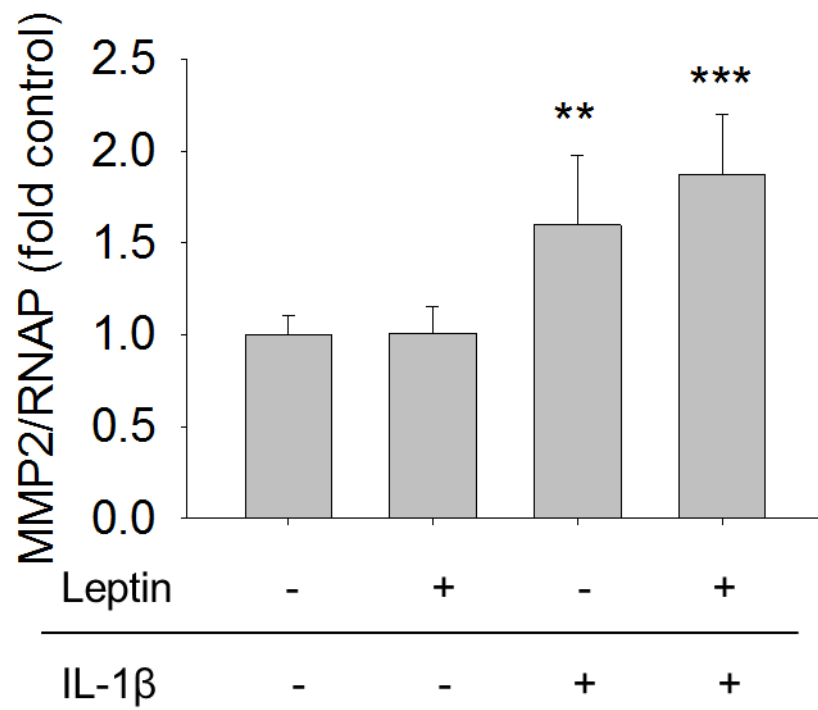

[G]

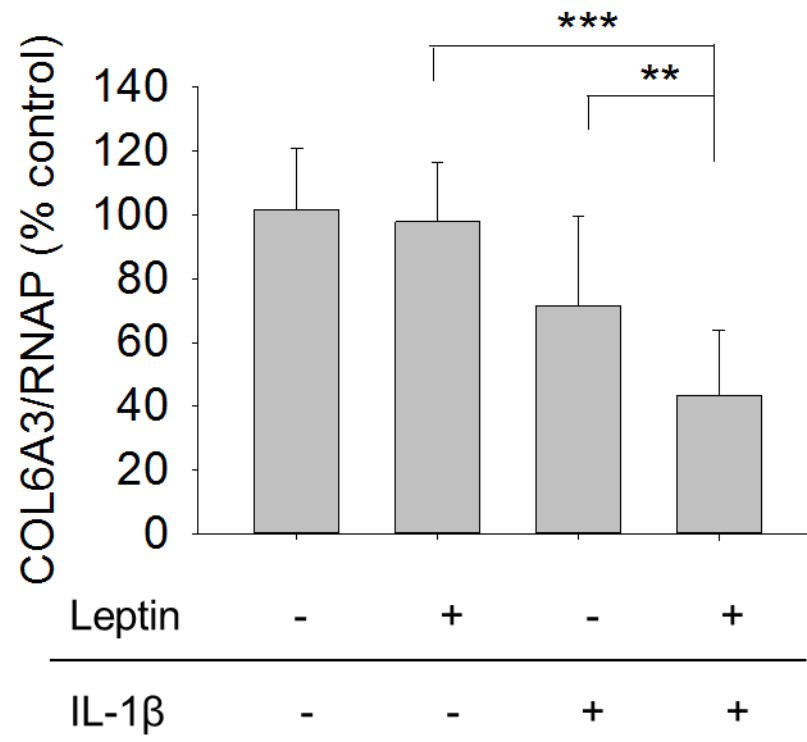

[H]

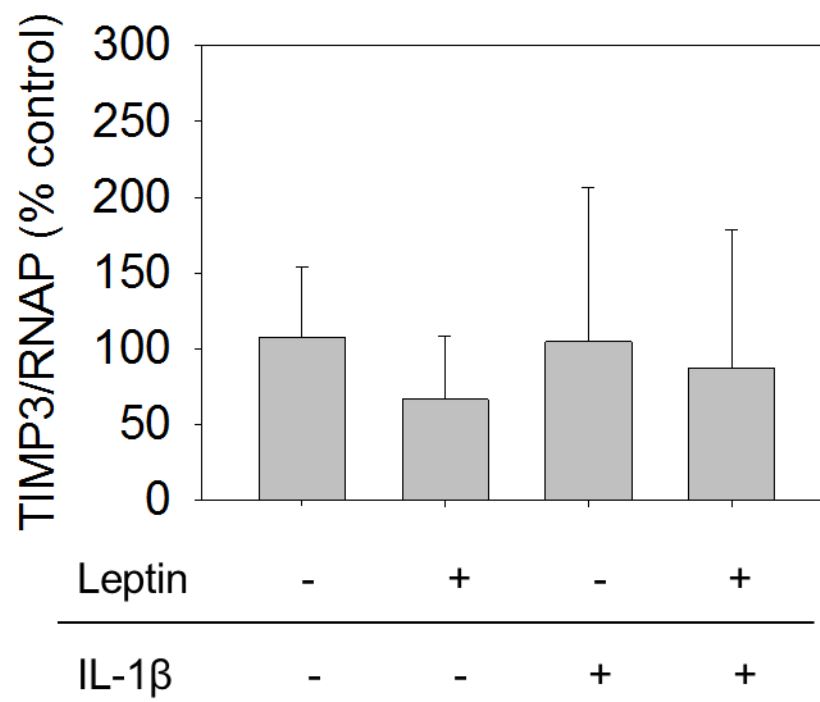

Figure 6.7: Real-time PCR analysis of genes chosen for further study from microarray analysis.

hGFs were stimulated with leptin (10 µg/ml), IL-1β (0.05 ng/ml) or leptin+IL-1β (leptin 10 µg/ml, IL-1β 0.05 ng/ml) for 24 h [A-F] 6-well format, [G-H] 96-well format. Cells were lysed and cDNA was prepared by reverse transcription. Real-time RT-PCR was used to assess [A] MMP-3, [B] IL-24, [C] MMP-8, [D] MMP-12, [E] MMP-14, [F] MMP-2, [G] collagen 6A1, [H] TIMP-3 and RNAP gene expression. [A, C-H] Relative gene expression was determined using the 2^{-ddCt} method by using RNAP as the reference gene. [B] Relative gene expression was determined by normalising to the reference gene RNAP. Data are shown as mean+SD ([A-F] n=6, [G-H] n=12) from three donors stimulated in independent experiments. Statistics: Mann-Whitney U test for independent samples (Bonferroni-corrected) *=p<0.05, **=p<0.01 ***=p<0.001 compared to unstimulated control unless indicated otherwise.

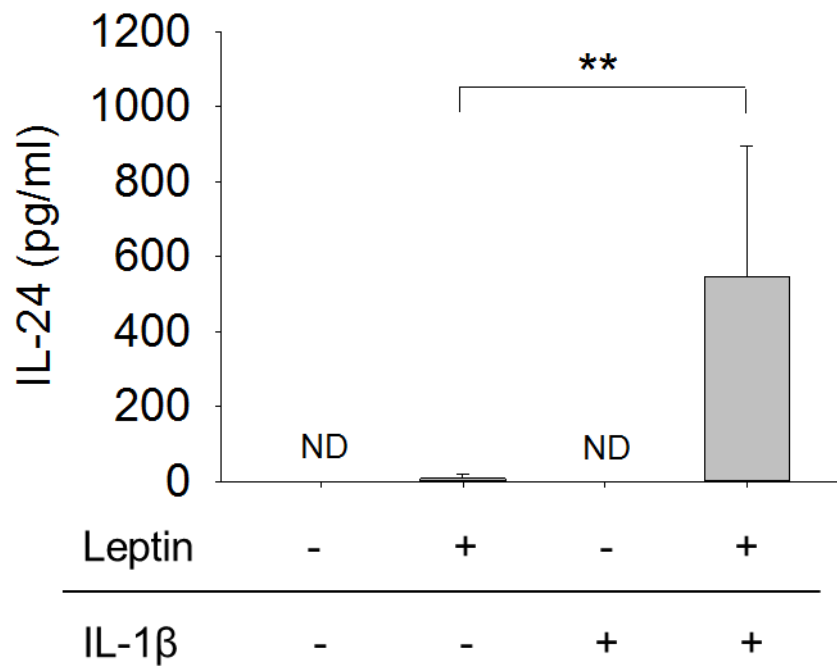

Figure 6.8: IL-24 secretion by hGFs after stimulation with leptin and IL-1

hGFs were either unstimulated or stimulated with leptin (10 $\mu\text{g/ml}$), IL-1 β (0.05 ng/ml) or leptin+IL-1 β (leptin 10 $\mu\text{g/ml}$, IL-1 β 0.05 ng/ml) for 24 h. Supernatants were collected and IL-24 concentrations were assessed by ELISA. Data (pg/ml) are shown as mean+SD (n=6) from three donors stimulated in independent experiments. Statistics: T test for independent samples (Bonferroni-corrected) **=p<0.01 as indicated. ND – not detected.

7 Chapter 7. Development of an explant model to assess leptin+IL-1-mediated gingival tissue collagen degradation

7.1 Introduction

Fibroblasts are the predominant cell type in gingival connective tissue, and are surrounded by a dense collagen-rich ECM (Bartold and Narayanan, 2006). Numerous studies, including the current study (Chapters 3, 4 and 6), have found that gingival fibroblasts produce both ECM components and enzymes that degrade ECM such as MMPs (Zhang *et al.*, 2011; Arancibia *et al.*, 2012; Mah *et al.*, 2014). As such, gingival fibroblasts are implicated in gingival tissue remodelling during health and disease.

Several studies have cultured gingival fibroblasts on or in collagen gel matrices to assess the production and activity of MMPs produced by gingival fibroblasts (Cox *et al.*, 2006; Smith *et al.*, 2009; Zhang *et al.*, 2010; Zhang *et al.*, 2011; Mah *et al.*, 2014). For example, Smith *et al.* (2009) found that human gingival fibroblasts stimulated with TNF- α on a type I collagen matrix produce higher levels of MMP-14 protein compared to plastic surfaces, and that the culture supernatants contain increased levels of active MMP-2; no TNF- α stimulated MMP-2 activity was observed in the supernatants of gingival fibroblasts cultured on a plastic surface.

In studies using hGFs seeded onto a central area of a type I collagen-coated surface, Zhang *et al* found that hGFs could degrade collagen in the pericellular area constitutively (Zhang *et al.*, 2010; Zhang *et al.*, 2011). Interestingly, the entire collagen-coated area could be degraded when gingival fibroblasts were treated with *P. gingivalis* supernatant, suggesting that under this condition inter-territorial ECM degradation is promoted by gingival fibroblasts. This collagen degradation was totally inhibited by the MMP inhibitor GM6001, which suggests that MMPs were responsible for the collagen degradation observed, instead of *P. gingivalis*-derived proteinases. After stimulation with *P. gingivalis* supernatant, gingival fibroblasts secrete increased active MMP-2, MMP-1 and MMP-3; under the same stimulatory conditions secreted levels of TIMP-1 were not altered, while levels of TIMP-2 were decreased (Zhang *et al.*, 2010; Zhang *et al.*, 2011). Taken together, these findings suggest that gingival fibroblast-derived MMPs can degrade type I collagen, and that this ability may be regulated by disrupting the balance of active MMPs to TIMPs.

Over a culture period of several days IL-1 β increases the concentration of hydroxyproline in supernatants from hGFs isolated from individuals with chronic periodontitis that were seeded onto a type I collagen matrix; the levels of active MMP-1, MMP-8 and MMP-13 tended to be higher in the supernatants of hGFs stimulated with IL-1 β compared to unstimulated cells (Cox *et al.*, 2006). This suggests that the pro-inflammatory cytokine IL-1 β promotes gingival fibroblast-mediated collagen degradation by increasing the secretion and activation of collagenases.

Other studies have assessed the production of ECM-degrading enzymes by whole oral mucosal tissues, in an effort to determine whether this is an appropriate model for ECM remodelling in health and disease. In the 1980s, and therefore prior to the identification of specific MMP family members, pro and active forms of collagenases and gelatinases (as assessed by an ability to degrade collagen or gelatin substrates respectively) were detected in both human and porcine gingival tissue supernatants (Pettigrew *et al.*, 1981; Heath *et al.*, 1982). More recently, gingival tissues have been engineered from individual cell populations and man-made scaffolds for use in clinical tissue engineering applications and as a research tool (Andrian *et al.*, 2004; Murata *et al.*, 2008). Murata *et al.* (2008) developed a tissue model by culturing gingival fibroblasts in a collagen-containing matrix, which was then grafted over teeth that were subject to gingival recession; after the grafting surgery, significantly increased gingival tissue attachment was observed. Andrian *et al.* (2004) developed a tissue model by culturing primary human palatal fibroblasts in a type III collagen matrix, then seeding primary human palatal epithelial cells on top of the fibroblast layer. Both MMP-2 and MMP-9 were secreted from this engineered human oral mucosa (EHOM) constitutively; however, no consistent changes in MMP levels were detected when EHOMs were infected with *P. gingivalis* (Andrian *et al.*, 2007). However, it is not yet clear whether cells within the oral mucosa (e.g. fibroblasts) can be stimulated to degrade collagen or other ECM components within the oral mucosal tissue in which they reside.

Studies of experimental periodontitis have been used to assess periodontal tissue destruction *in vivo* (Hasturk *et al.*, 2006; Branch-Mays *et al.*, 2008; Cantley *et al.*, 2009; Cantley *et al.*, 2011). Most of these studies have induced periodontitis in rodents (mice or rats), but rabbits and rhesus monkeys have also been used (Bjornsson *et al.*, 2004; Hasturk *et al.*, 2006; Branch-Mays *et al.*, 2008; Ohnishi *et al.*, 2010). In animal models periodontitis can be induced by placing a ligature around selected teeth; alternatively, periodontitis is induced by oral gavage with bacteria (*P. gingivalis* or *A.*

actinomycetemcomitans) (Bjornsson *et al.*, 2004; Cantley *et al.*, 2009; Trombone *et al.*, 2009). The most common measurements of disease in experimental periodontitis are alveolar bone loss, markers relevant to osteoclastogenesis (RANKL, tartrate-resistant acid phosphatase) and histological analyses of inflammatory infiltrates (Serhan *et al.*, 2003; Hasturk *et al.*, 2006; Trombone *et al.*, 2009). Additionally, in a study of experimental periodontitis in rhesus monkeys, periodontitis was characterised by clinical indices (gingival index, BOP, CAL, PD) similar to the human disease (Branch-Mays *et al.*, 2008). Increased gingival MMP levels are detected after the induction of experimental periodontitis (Achong *et al.*, 2003; Vardar-Sengul *et al.*, 2008); whether the degradation of gingival tissue ECM is similarly increased was not investigated.

Leptin and IL-1 synergistically increase the expression of the collagenases MMP-1 and MMP-13 in chondrocytes (Hui *et al.*, 2012). In this study, Hui *et al.* (2012) also utilised a fairly well established bovine nasal cartilage explant model to show that leptin+IL-1 synergistically increase cartilage collagen degradation after a 14 day stimulation period. Collagen degradation was assessed by measuring the proportion of the amino acid hydroxyproline in the cartilage supernatants. MMP activity was also assessed in these cartilage supernatants by gelatin zymography (to assess gelatinase activity) and by using a tritiated collagen substrate (to assess collagenase activity). As chondrocytes are the only cell type found within cartilage, Hui *et al.* (2012) concluded that leptin+IL-1 function to promote cartilage degradation via increasing the production (and activity) of MMPs by chondrocytes. No studies have investigated the functional ability of leptin (\pm IL-1) to regulate periodontal tissue remodelling.

Previously, it was shown that leptin and IL-1 synergistically upregulate the production of MMPs by hGFs (Chapters 4 and 6). Additionally, it was shown that leptin and IL-1 had no similar ability to alter TIMP gene expression by hGFs, yet significantly reduced the levels of several collagen mRNAs. This suggested that leptin and IL-1 synergistically promote an ECM-degrading gingival fibroblast phenotype. However the functional significance of this phenotype in gingival tissue is yet to be explored. Several experimental approaches have been used to assess MMP production and ECM degradation in the periodontal tissues; however no studies have attempted to investigate whether leptin can regulate gingival tissue integrity. The aim of the results presented in this chapter was to investigate the role of leptin on tissue integrity by developing a gingival tissue explant model system.

7.2 Development of a gingival tissue explant model

A tissue explant-based approach was developed to investigate ECM degradation under inflammatory conditions (Section 2.2.9). The development process for this model consisted of:

1. Microscopic and histological analysis of gingival tissue
2. An assessment of gingival connective tissue (CT) viability and morphology after a range of *ex vivo* culture periods
3. Determining whether ECM degradation in the gingival CT explant could be measured after stimulation with the potent pro-inflammatory stimuli IL-1+OSM.

7.2.1 Characterisation of gingival tissue

Sections of human gingival tissue were stained with H+E for histological analysis (Figure 7.1). A thick epithelial layer was observed which was keratinised at the surface, and the epithelial basal cell layer could be seen at the basement membrane. Rete pegs were evident, as were numerous fibroblast cell nuclei in the connective tissue layer. The connective tissue subjacent to the epithelium appeared to have a denser collagen ECM compared to the connective tissue papillae (between the rete pegs).

Interestingly, light microscopic analysis of gingival CT identified areas rich in transparent, spherical cells characteristic of adipocytes (Figure 7.2A). Subsequently, similar monovacuolar cells, or potential adipocytes, were identified during histological analysis of gingival CT (Figure 7.2B). To provide further evidence that these transparent, spherical cells were adipocytes, gingival CT pieces were stained with a dye for triglycerides (Figure 7.3) (Section 2.2.8). The strongest triglyceride staining was observed within the monovacuolar cells of the gingival CT, which is in support of these cells being gingival tissue resident adipocytes.

These microscopic analyses confirmed that gingival tissue is complex; differences observed in ECM degradation may be affected by the composition of each gingival tissue piece. Therefore, dissection of gingival tissue into pieces for use in the explant model was performed such that tissue pieces from neighbouring areas were distributed across treatment conditions.

7.2.2 Morphology and viability of gingival CT explants

The gross morphology and pH of gingival CT explant cultures *ex vivo* were studied to determine whether they varied over time. Phenol red in the cell culture medium gives a

visual indication of the pH of the medium the tissue is suspended in. Over time, due to waste metabolites accumulating, tissue culture medium becomes more acidic and this can affect the viability of the tissue. In the one donor assessed, no changes in the gross morphology of the multiple gingival CT pieces cultured in SFM were observed by light microscopy over an 11 day culture period (daily observation). The medium was changed every 3-4 days and over this duration of incubation no medium acidification was observed. This practise was taken forward for use in subsequent stimulation experiments; all supernatants (e.g. all treatment conditions) were changed at the same time.

LDH activity was assessed in supernatants collected from gingival CT pieces incubated in SFM for 3, 7, 10, 14, 17 and 21 days as a measure of tissue viability. No LDH activity was quantified at any of these time points; absorbance values were below the lower limit of quantification. This suggests that the viability of these gingival CT pieces was maintained over the culture period.

Over the first few days of *ex vivo* culture some cells moved out of the gingival CT explant into the culture supernatant. Light microscopic analysis identified that these cells consisted mainly of red blood cells, and other small, non-adherent spherical cells (probably white blood cells). However, once the culture medium was changed after 3 days few other cells were identified in the culture supernatant. Unlike the protocol for fibroblast isolation (Section 2.2.1), adherence to cell culture plastic ware was not promoted for gingival CT pieces during *ex vivo* culture to reduce the development of fibroblast outgrowths. This was done by dispensing a larger volume of culture medium such that the tissue pieces were suspended.

7.2.3 Degradation of gingival CT ECM after stimulation with IL-1+OSM

Gingival CT pieces from one donor were prepared for *ex vivo* stimulation (Section 2.2.9). These tissue pieces were stimulated with 0.05 ng/ml IL-1 and 5 ng/ml OSM for 21 days. Unstimulated gingival CT pieces were used as a negative control. Supernatants were removed, stored for analysis and replaced with fresh SFM or IL-1+OSM as required. At the end of the stimulation period the gingival tissue pieces were enzymatically digested. GAG and hydroxyproline release from the gingival CT pieces were assessed to determine whether IL-1+OSM (which enhance MMP production by hGFs (Section 4.2)) could enhance gingival ECM degradation. MMP and LDH activities were also assessed in the culture supernatants.

IL-1+OSM had no significant effect on GAG release from gingival CT compared to the unstimulated control (Figure 7.4). By day 7 unstimulated and IL-1+OSM-stimulated gingival CT had released 42 % and 46 % GAG respectively; by day 21 almost all GAG had been released (unstimulated 94 %, IL-1+OSM 96 %).

Cumulative hydroxyproline release was detected in all of the IL-1+OSM-stimulated gingival CT pieces (mean \pm SD day 7: 22 \pm 5 %, day 14: 45 \pm 6 %, day 21: 60 \pm 12 %) (Figure 7.5). In contrast, lower cumulative hydroxyproline release was detected in two of the three unstimulated pieces of gingival CT (mean \pm SD of 2 gingival tissue pieces, day 7: 2.0 \pm 0.1 %, day 14: 4.5 \pm 0.4 %, day 21: 6.4 \pm 0.2 %). However, in one of the unstimulated pieces of gingival CT, levels of hydroxyproline release similar to gingival CT pieces stimulated with IL-1+OSM were detected (day 7: 21 %, day 14: 40 %, day 21: 50 %).

Interestingly, the pieces of gingival CT that had a cumulative hydroxyproline release of > 10 % by day 21 contained a lower amount of total hydroxyproline than the other pieces of gingival CT (Table 7.1). This suggested that the total hydroxyproline content of a piece of gingival CT may affect the degree of hydroxyproline release; in subsequent stimulations gingival CT pieces with visibly different sizes (and therefore presumably different amounts of collagen) were distributed across treatment conditions. In an effort to generate pieces of gingival CT of an identical size a biopsy punch was trialled; however, these punches are designed for acquiring a piece of tissue embedded in a larger structure, and therefore were not as effective in dissecting gingival tissue as compared to a scalpel and forceps.

MMP activity in gingival CT supernatants was analysed in two ways (Figure 7.6). No significant differences in MMP activity (in RFU) were detected between IL-1+OSM-stimulated gingival CT pieces compared to the unstimulated control (Figure 7.6A). However, MMP activity tended to be higher in gingival CT treated with IL-1+OSM compared to the unstimulated controls at all time points studied. Due to the different amounts of hydroxyproline between the gingival CT pieces, MMP activity was also expressed relative to hydroxyproline for each sample (Figure 7.6B). MMP activity expressed in this manner resulted in a similar pattern of results to those generated for hydroxyproline release (Figure 7.5 and Table 7.1); e.g. samples with less total hydroxyproline had increased MMP activity. As collagen is the predominant ECM component of gingival CT (Bartold and Narayanan, 2006), MMP activity was presented

relative to total hydroxyproline levels in an effort to control for differences in tissue piece sizes in subsequent stimulations.

No LDH activity was detected in unstimulated or IL-1+OSM stimulated gingival CT supernatants at any time points as absorbance values were below the lower limit of quantification.

7.3 Regulation of collagen degradation in gingival CT by leptin and IL-1 α

Gingival CT pieces were prepared for *ex vivo* stimulation (Section 2.2.9). Gingival CT pieces were either unstimulated or stimulated with 10 μ g/ml leptin and 0.05 ng/ml IL-1 α for 21 days. Supernatants were removed, stored for analysis and replaced with fresh SFM or leptin+IL-1 as required. At the end of the stimulation period the gingival CT pieces were enzymatically digested. Hydroxyproline release from the gingival CT pieces was assessed to determine whether leptin+IL-1 enhances gingival ECM degradation. MMP activity and LDH activity were also assessed in the culture supernatants.

The patterns of hydroxyproline release varied between the donors tested (Figure 7.7). In donor 8, significantly more hydroxyproline was released from leptin+IL-1-stimulated gingival CT compared to the unstimulated control after a 21 day culture period. No similar significant difference was observed in this donor at earlier time points (day 7 and day 14), although leptin+IL-1-stimulated gingival CT tended to have higher hydroxyproline release compared to the unstimulated control. In the other two donors tested no significant difference between leptin+IL-1-stimulated tissue and the unstimulated control was observed at any time point assessed. Of note, over 40 % hydroxyproline release was detected for both leptin+IL-1 and unstimulated gingival CT pieces at day 7 in donor 9. Coincident with this was a visible and extensive degradation of gingival CT and release of cells into the supernatant in this donor.

Gingival CT pieces from donor 10 were also stimulated with leptin (10 μ g/ml) or IL-1 (0.05 ng/ml) alone to identify whether these stimuli had any effect on gingival CT collagen degradation in isolation (Figure 7.8). Leptin and IL-1 had no significant effect on hydroxyproline release at any time points tested (days 7, 14 and 21) as compared to the unstimulated control and leptin+IL-1-stimulated gingival CT pieces.

MMP activity in gingival CT supernatants varied between the two donors tested (Figure 7.9). No significant differences in MMP activity (corrected for tissue hydroxyproline

content) between leptin+IL-1-stimulated gingival CT and the unstimulated control were observed at any time point (days 7, 14 and 21) in both donors. MMP activity tended to be higher in leptin+IL-1-stimulated gingival CT from donor 9 at the day 7 and day 14 time points in comparison to the unstimulated control; however no similar trend was evident at the 21 day time point.

MMP activity was subsequently assessed in gingival CT after stimulation with leptin+IL-1 (leptin 10 µg/ml, IL-1 α 0.05 ng/ml) in the absence or presence of the MMP inhibitor GM6001 (10 µM) to confirm that active MMP was present in gingival CT supernatants (Figure 7.10). Significantly lower levels of MMP activity (RFU) were detected in gingival CT pieces that were incubated with GM6001 in both the absence and presence of leptin+IL-1 at the day 3 time point assessed (unstimulated $p < 0.001$, leptin+IL-1 stimulation $p < 0.01$). No visible differences in GM6001-treated gingival CT was observed in comparison to un-treated samples.

LDH activity was assessed in gingival CT supernatants derived from two donors (donors 8 and 9). No LDH activity was quantified in unstimulated or leptin+IL-1 stimulated gingival CT supernatants at any time points as absorbance values were below the lower limit of quantification.

7.4 Discussion

Several experimental approaches have been developed to investigate collagen degradation in periodontal tissues, and by periodontal cells (Cox *et al.*, 2006; Hasturk *et al.*, 2006; Cantley *et al.*, 2009; Zhang *et al.*, 2010). Fibroblasts are the predominant cell in gingival connective tissue and are implicated in regulating gingival ECM integrity (Bartold and Narayanan, 2006). It was previously shown that leptin and IL-1 synergistically promote an ECM-degrading gingival fibroblast phenotype (Chapter 4); however the functional relevance of this finding was unclear. However, leptin and IL-1 synergistically promote bovine cartilage collagen degradation (Hui *et al.*, 2012), and it was hypothesised that leptin and IL-1 may have a similar function on collagen in gingival tissue. The results presented in this chapter showed that leptin and IL-1 had no significant ability to upregulate collagen degradation and MMP activity in gingival connective tissue explants. However, both collagen and GAG degradation was observed in gingival connective tissue explants, and MMP activity was detected. This suggests that further optimisation of these gingival connective tissue explants may be justified in an effort to model gingival ECM integrity during the presence of leptin and IL-1.

The size of the gingival connective tissue pieces used in this study was similar to those used previously to assess collagen degradation in human cartilage (Morgan *et al.*, 2006). However, because cartilage is avascular, chondrocytes are required to survive in hypoxic and somewhat nutrient-deficient conditions, and rely on the diffusion of nutrients and stimuli through the tissue (Poole, 1997). In contrast, gingival tissue is vascular (Bartold and Narayanan, 2006), and hypoxic or nutrient-deficient conditions (e.g. due to disruptions in the gingival vasculature) may affect gingival cell responses and eventually result in cell and tissue death (Deschaumes *et al.*, 2007; Kim *et al.*, 2010a). This suggests that cartilage may be more amenable to explant culture where nutrients diffuse into the tissue than gingival connective tissue, at least in the absence of some kind of perfusion system. Interestingly, no indications of tissue damage (as assessed by LDH release) were identified for gingival tissue pieces over the period of incubation assessed in this study, although whether the pieces of gingival tissue were large enough to generate a quantitative LDH signal was undetermined. However, it is well established in tumour biology that a lack of nutrients and oxygen to cells in the centre of a tumour can promote cell death, while the peripheral cells remain viable and functional (Lowe and Lin, 2000). Perhaps cells in the centre of the gingival connective tissue explant may have released LDH during the process of cell death but no LDH was released into the culture supernatants. Similarly, due to a lack of perfusion it is possible that only the more external cells in the gingival connective tissue pieces were responding to leptin and IL-1; whether this was occurring and whether it would have had any effect on leptin+IL-1 stimulated collagen degradation is unclear. In a previous study aiming to assess the ability of IL-1 to promote collagen degradation by gingival fibroblasts seeded on a collagen matrix, higher concentrations of IL-1 (1-20 ng/ml) were used in comparison to the concentration used in this study (0.05 ng/ml) (Cox *et al.*, 2006). Therefore, one possible alteration to the experimental design used in this study would be to use higher concentrations of leptin and IL-1.

Not only may the size of the gingival connective tissue pieces used in this study have affected tissue viability, but it may also have affected the reproducibility of the amount of collagen degradation observed between identically-treated gingival tissue pieces. Ideally, to correct for the influence of gingival tissue size on MMP activity in culture supernatants these measurements would have been corrected to total protein or tissue mass as has been used previously (Rosengren *et al.*, 2003; Fowler *et al.*, 2014). However, in this study, due to the papain digestion required for hydroxyproline

analysis, and the small size of tissue pieces used, neither the assessment of total protein or tissue mass were feasible. Collagen is the predominant ECM protein found in gingival connective tissue (Bartold and Narayanan, 2006), and hydroxyproline is one of the major amino acids that makes up fibrillar collagens (Gorres and Raines, 2010). Both hydroxyproline and total protein levels have been assessed in human gingiva previously, and there is some correlation between the two measurements (Akalin *et al.*, 1993). Therefore, MMP activity was expressed in proportion to tissue hydroxyproline content in an effort to control for differences in tissue size. One potential problem with using hydroxyproline content to correct for tissue size is that collagen content of the gingiva varies, as observed by histologic analysis in this study and previously (Nanci, 2013). Therefore, the different amounts of hydroxyproline detected between gingival tissue pieces in this study may have represented the densities of collagen matrix and not tissue size. Nonetheless, in this study using GM6001 to inhibit MMP activity significant changes in MMP activity were observed without any correction for gingival tissue hydroxyproline content. This suggests that if leptin and IL-1 had a large differential effect on MMP activity as compared to unstimulated cells, that this would have been detected independent of tissue size or hydroxyproline content.

The H+E section of a piece of gingival tissue acquired in this study demonstrated the characteristic histological features of this complex tissue (Nanci, 2013). However, the nature of the processing used to generate multiple pieces of gingival tissue from the same donor may have affected the utility of this explant culture model by generating tissue pieces with an unrepresentative cell population. Fibroblasts are the predominant cell type in gingival connective tissue but other cell types are present (endothelial cells, resident leukocytes, neurones) (Bartold and Narayanan, 2006). Additionally, the original pieces of tissue acquired contained the gingival epithelium, which was subsequently removed using a scalpel. The basement membrane between the gingival epithelium and connective tissue is not flat, as evidence by the rete pegs and connective tissue processes identified in the gingiva by histology. Therefore, it was likely that some epithelial cells may have been present in the gingival tissue pieces used for explant culture. The enzyme dispase can detach the epithelium from connective tissue as dispase degrades type IV collagen which is found in basement membranes (Normand and Karasek, 1995); this approach was not optimised in this study. Fibroblasts bi-directionally interact with endothelial cells, leukocytes and epithelial cells (Yucel-Lindberg *et al.*, 2001; Velazquez *et al.*, 2002; Sorrell *et al.*, 2008; Tandara and Mustoe,

2011), suggesting that interactions between different cell types in gingival tissue may have altered fibroblast responsiveness. Endothelial cells, leukocytes and epithelial cells all also respond to leptin and IL-1 individually (no studies have investigated IL-1 and leptin in combination on these cell types) (Cozzolino *et al.*, 1990; Eskan *et al.*, 2008; Sukhotnik *et al.*, 2009; Fernandez-Riejos *et al.*, 2010; Saxena *et al.*, 2013), and these cells are all implicated in regulating ECM integrity (Park *et al.*, 2001; Delima and Van Dyke, 2003; Andrian *et al.*, 2007). Functionally different fibroblast populations have also been identified within the periodontium (Jonsson *et al.*, 2011), and within the gingiva (Irwin *et al.*, 1994). Perhaps distinct fibroblast populations predominated in different gingival connective tissue pieces, and had differing abilities to regulate ECM remodelling. Together, this suggests that the measurement of leptin+IL-1 stimulated ECM degradation using gingival connective tissue explants as assessed in this study, would have been a complex measure of the collective responses of all of these cell types and subtypes.

Interestingly, ECM degradation has been observed in unstimulated human articular cartilage previously (Morgan *et al.*, 2006), and was also observed in unstimulated gingival tissue in this study. Morgan *et al.* (2006) suggested that ECM degradation in unstimulated articular cartilage may have been because the cartilage used was donated by individuals who were about to undergo joint replacement surgery as a treatment for arthritis, and therefore these tissue pieces already had some integral active proteinase activity. This could also explain the ability of IL-1 to stimulate collagen degradation by hGFs cultured on a collagen matrix because the fibroblasts used were isolated from individuals with chronic periodontitis (Cox *et al.*, 2006). As fibroblasts isolated from inflammatory sites have been shown to maintain an inflammatory phenotype *in vitro* (McGettrick *et al.*, 2009), it is possible that the fibroblasts used by Cox *et al.* (2006) had an intrinsic matrix-degrading phenotype in contrast to the fibroblasts within the essentially healthy gingival tissue used in this study. It is unlikely that this is why ECM degradation occurred in unstimulated gingival tissue as the donors were essentially periodontally healthy. However, gingival tissue from one of the donors both disintegrated visually and had a correspondingly large release of collagen at the earliest time point assessed, suggesting that the gingival tissue acquired from this donor was more susceptible to ECM degradation than other donors. In agreement with donor dependent susceptibilities to gingival tissue degradation, are the clinical studies showing that certain individuals are more likely to develop periodontitis (Taylor *et al.*, 2004;

Kornman, 2008; Preshaw *et al.*, 2012), and the *in vitro* studies showing that hGFs from different donors respond variably (Tipton *et al.*, 1991; Sukkar *et al.*, 2007; Uehara and Takada, 2007). Although the scalpel has been shown to induce minimal tissue damage (Liboon *et al.*, 1997), scalpel incisions still promote inflammation and wounding responses that take days to resolve (Homayounfar *et al.*, 2012; Nanduri *et al.*, 2013). Therefore, the tissue processing performed prior to gingival tissue culture may have promoted inflammatory responses in all gingival tissue pieces which masked any effect of leptin and IL-1 on gingival ECM degradation.

No previous studies have used gingival connective tissue explants to study ECM integrity during inflammatory conditions; the most similar model is probably the EHOM utilised by Andrian *et al.* (2007). However, the EHOM lacks several mucosal cell types and a physiological ECM, therefore the responses generated may not translate to *in vivo* oral mucosal tissue function. Similarly, studies using gingival fibroblasts cultured on a collagen matrix are likely to be even less representative of the gingival connective tissue *in vivo* for the same reasons (Cox *et al.*, 2006; Zhang *et al.*, 2010; Zhang *et al.*, 2011). Indeed, fibroblasts in two-dimensional cell culture studies have an altered morphology to fibroblasts in three-dimensional culture and *in vivo* (Cukierman *et al.*, 2001; Beningo *et al.*, 2004). Gingival fibroblast responses also differ depending on whether the cells are cultured on plastic or on a collagen matrix (Smith *et al.*, 2009). Therefore, the translatability of simple *in vitro* studies to more complex environments (such as *in vivo*) is questionable and any functional outcomes have to be interpreted with caution.

On the other hand, *in vivo* experimental periodontitis models have been used to understand the functional outcomes of inflammation in the periodontium. There are several potential difficulties in studying the ability of leptin to directly regulate gingival fibroblast-mediated ECM degradation *in vivo*. Firstly, while leptin or leptin receptor-deficient animals have been extensively studied (Myers *et al.*, 2008), it is clear that these animals have wide-spread systemic alterations (Coleman, 2010; Soboku *et al.*, 2014). Therefore, it would be difficult to assess whether any ability of gingival fibroblasts to regulate ECM degradation in these animals was due to a direct effect of leptin on gingival fibroblasts or an indirect effect due to deficient systemic leptin signalling. Usually, to investigate the function of leptin on a specific cell type *in vivo*, genetic manipulation studies are performed to selectively knockout leptin receptor expression; a process that has been used to success in studies of neurons and adipocytes

(Cohen *et al.*, 2001; Huan *et al.*, 2003). However, this cell-type specific genetic manipulation requires a cell-type specific marker. As no unique but consistent fibroblast marker has been identified (Naylor *et al.*, 2012), this approach is not yet feasible to study fibroblast functions *in vivo*. In the past, it has also been difficult to study MMP activity *in vivo*. However, recent studies have used a fluorescent cleavable MMP substrate similar to the one used in this study to monitor MMP activity, and how this relates to tissue degradation, over the course of experimental animal studies (Sheth *et al.*, 2012; Thorek *et al.*, 2013). Given the hypothesised importance of MMPs in the pathogenesis of periodontitis, it would be interesting to test whether this approach could be used to measure MMP activity in models of experimental periodontitis.

Finally, recent studies have shown that studies of inflammatory responses in animal models do not translate well to human inflammatory responses (Schroder *et al.*, 2012; Seok *et al.*, 2013), and similarly that inflammatory responses vary between animal strains (Uhlrig and Powrie, 2009; Schroder *et al.*, 2012). Furthermore, the effect that leptin deficiency has on growth in humans and mice is also different between species (Kelesidis *et al.*, 2010). Therefore, while animal models may help to model systemic and temporal properties of health and disease in humans, these responses do not necessarily directly translate between species. Consequently, *ex vivo* studies modelling periodontitis in human tissue may be more functionally relevant to human periodontitis than studies of experimental periodontitis in animals.

If gingival connective tissue explants are to be used in future studies it will be important to attempt to generate reproducible pieces of gingival tissue (in terms of size and content), to alter the size or shape of explant pieces to ensure that all cells are exposed to nutrients and stimuli, and to minimise the damage generated during tissue processing. One possible approach is the use of precision-cut slicing; this technology uses a vibratome to generate viable 200 μm slices of tissues (de Graaf *et al.*, 2010). This approach appears to show some promise regarding studies of liver function *ex vivo* (de Graaf *et al.*, 2010), and a pilot experiment in this study found that gingival tissue could be similarly processed, and maintained the characteristic gingival structure as determined by histological analysis (Figure 7.2B). Future development of a gingival tissue explant model using precision-cut slicing is warranted and may provide a useful bridge between descriptive *in vitro* studies of human gingival cells and functional experimental animal studies of gingival and/or periodontal tissues *in vivo*.

Adipocytes have been reported (albeit rarely) in gingival tissues previously (Nanci, 2013), in agreement with the findings in this study. The adipocytes identified in the current study have the same unique morphological structure and stain strongly for triglycerides as identified in previous studies (Prattes *et al.*, 2000; He *et al.*, 2010). This supports the hypothesis that these cells are indeed adipocytes. Adipocytes are one of the main cell types that produce leptin (Zhang *et al.*, 1994), and therefore this finding suggests that in some individuals there is a local source of leptin in the gingiva. Future studies to confirm whether these putative adipocytes do produce leptin are warranted, and may help to support a role for leptin in regulating gingival fibroblast function.

In conclusion, using gingival connective tissue explants no evidence was found to support the hypothesis that leptin and IL-1 increase gingival ECM degradation. However, while ECM components and MMP activity were measured in gingival connective tissue explants in this study, it is likely that in the current format gingival connective tissue explants are not a suitable model to investigate gingival tissue integrity under inflammatory conditions. A gap between *in vitro* and *in vivo* studies does exist regarding fibroblast function in the gingiva and may be bridged in the future by *ex vivo* models. Therefore, the results presented in this chapter highlight some of the issues that may need to be taken into account in future studies.

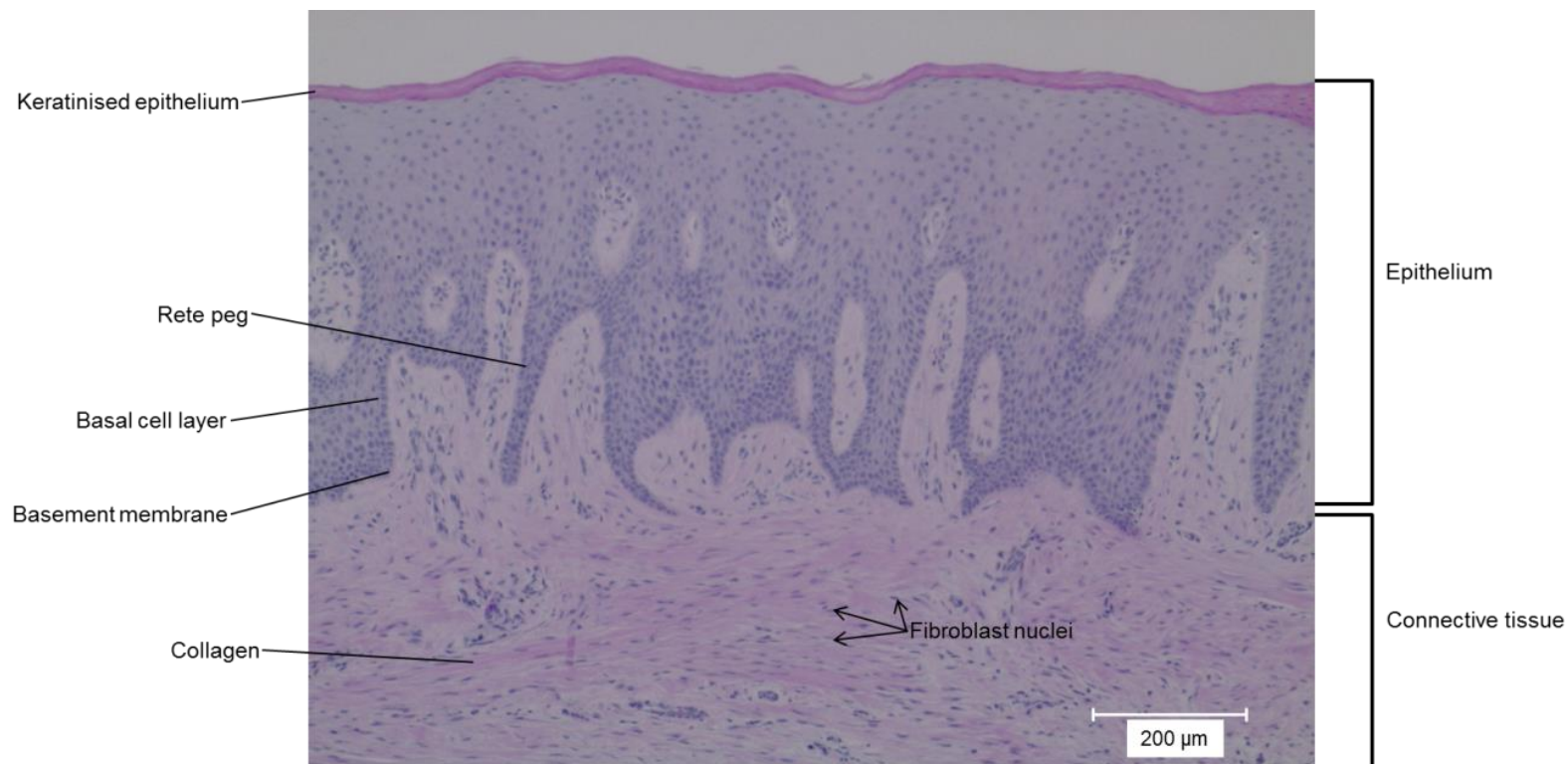

Figure 7.1: Histology of a piece of gingival tissue acquired in this study.

Gingival tissue acquired after canine exposure surgery was prepared for histological analysis. Sections of gingival tissue were stained with H+E. A representative image is shown which displays the keratinised gingival epithelium and connective tissue. Numerous fibroblast nuclei are present in the gingival connective tissue. The pink staining in the gingival connective tissue is indicative of a dense collagen extracellular matrix. Magnification 100x.

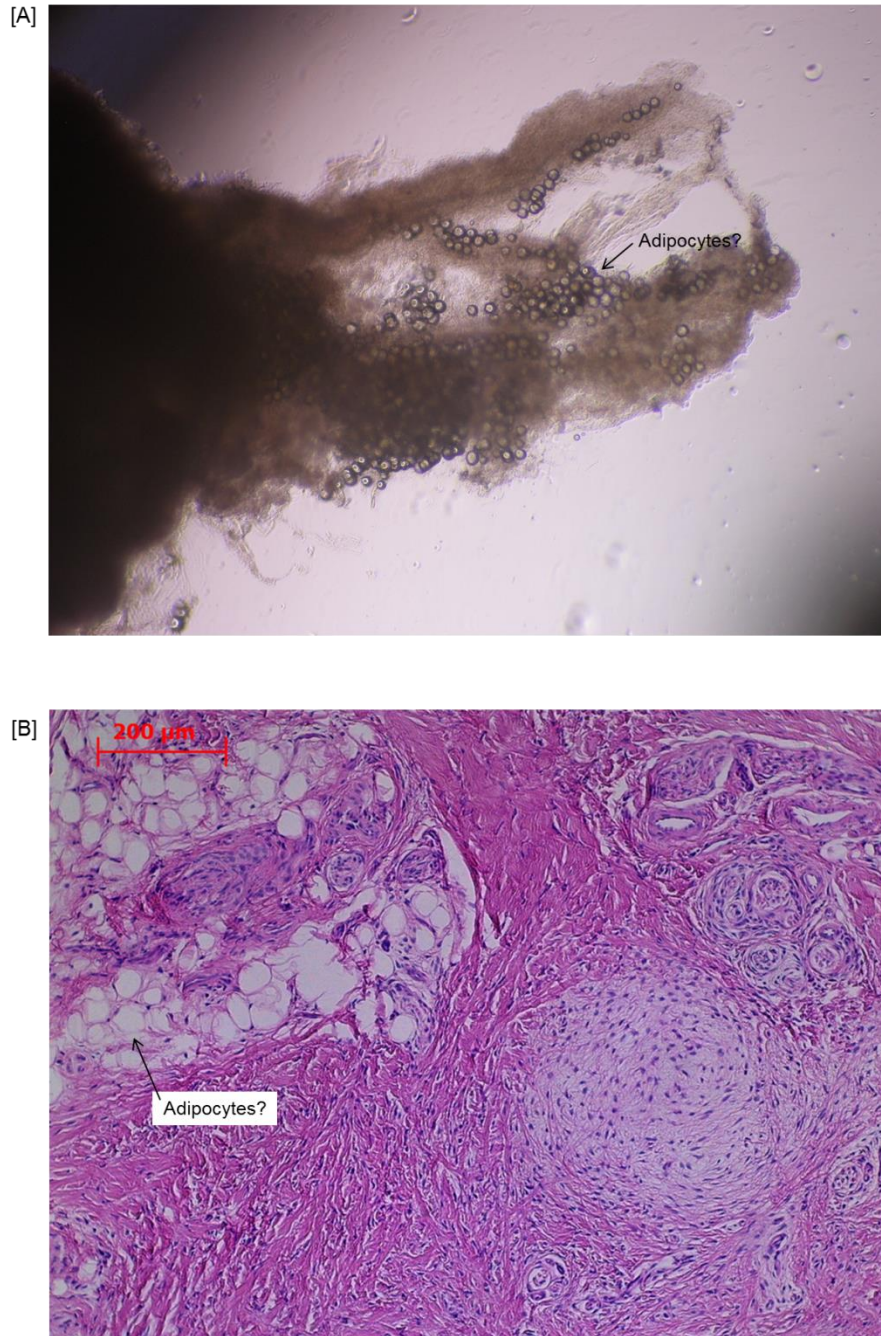

Figure 7.2: Potential adipocytes in gingival connective tissue.

Gingival tissue was acquired after canine exposure surgery. [A] Gingival tissue was dissected into small pieces (2 mm^3), these tissue pieces were suspended in PBS and imaged by light microscopy. A representative image is shown featuring a group of spherical cells that may be adipocytes. Magnification 20 x. [B] Gingival tissue was dissected by precision cut slicing and prepared for histological analysis. Sections of gingival tissue were stained with H+E. A representative image is shown featuring a group of monovacuolar cells that may be adipocytes. Magnification 100 x.

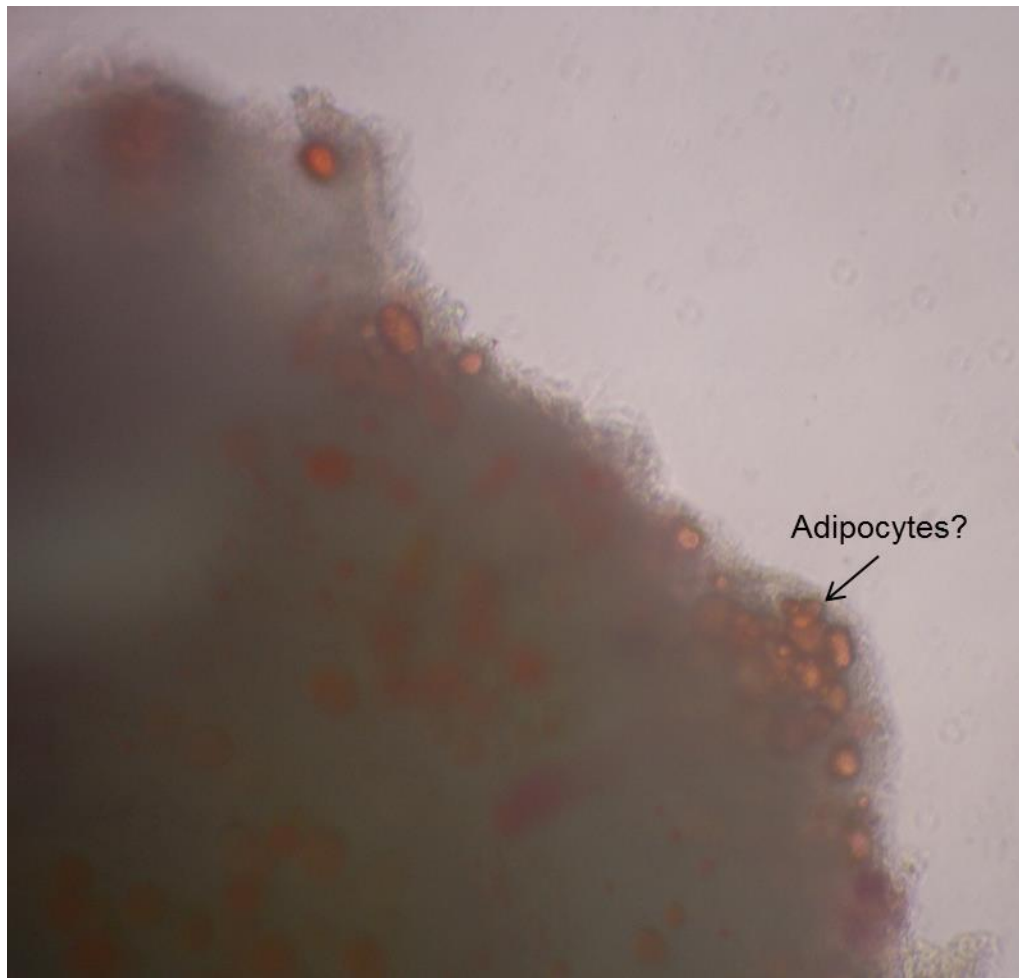

Figure 7.3: Adipocytes in gingival connective tissue

Gingival tissue was acquired after canine exposure surgery. Gingival tissue was dissected into small pieces (2 mm^3). These tissue pieces were stained with the triglyceride dye AdipoRed for 10 minutes before imaging by light microscopy. A representative image is shown in which the putative adipocytes stain strongly for triglycerides. Magnification 100 x.

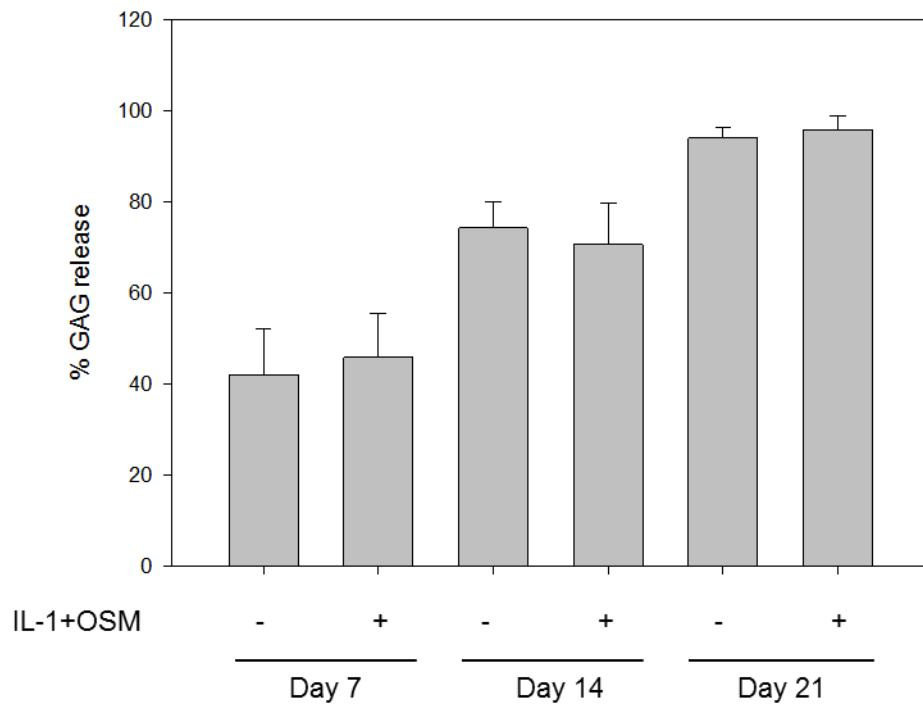

Figure 7.4: Cumulative GAG release from gingival tissue explants over time.

Gingival tissue from one donor was acquired after canine exposure surgery. Gingival tissue was washed, the epithelium removed by scalpel, and the resultant connective tissue dissected into small pieces (approximately 2 mm³). These tissue pieces were either cultured in SFM or stimulated with 0.05 ng/ml IL-1 α and 5 ng/ml OSM for 21 days. Culture supernatants were removed and replaced with fresh treatments as required. The amounts of GAG in the culture supernatants were determined and were compared to the total amount of GAG in the gingival tissue. Data (mean+SD) are presented as cumulative % GAG release from gingival tissue (n=3) at three time points (day 7, day 14, day 21). Statistics: T tests for independent samples.

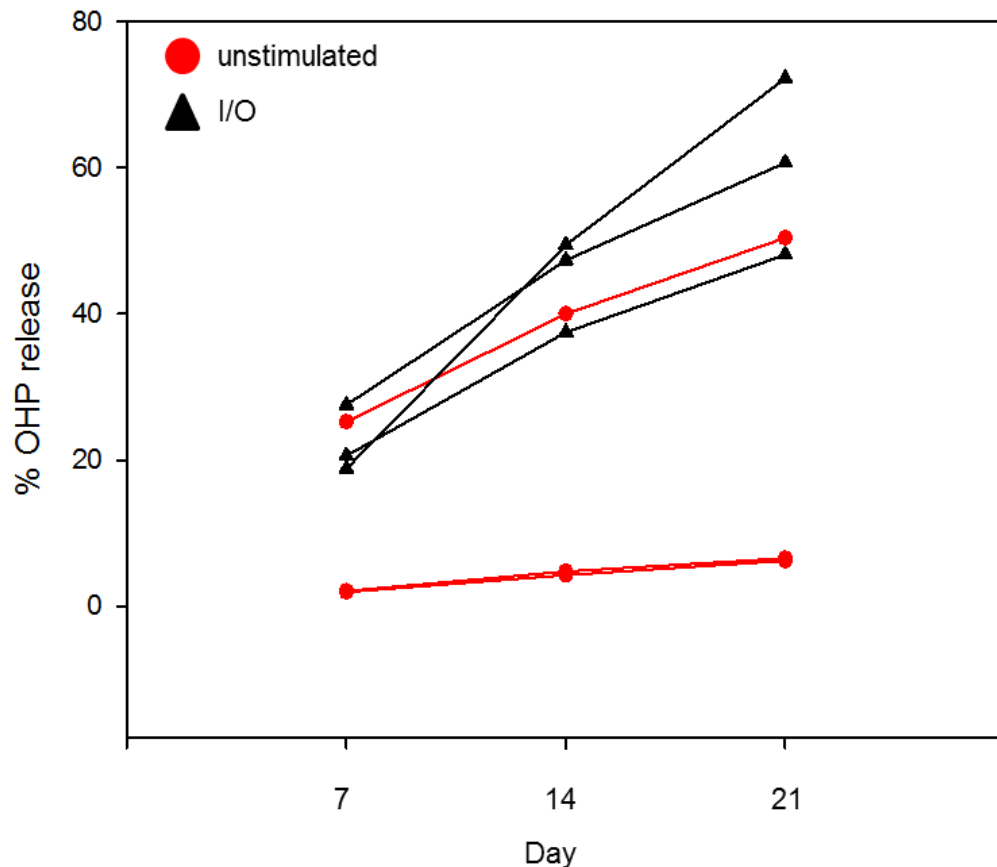

Figure 7.5: Cumulative hydroxyproline release from IL-1+OSM stimulated gingival tissue explants over time.

Gingival tissue from one donor was acquired after canine exposure surgery. Gingival tissue was washed, the epithelium removed by scalpel, and the resultant connective tissue dissected into small pieces (approximately 2 mm³). These tissue pieces were either cultured in SFM (unstimulated ●) or stimulated with 0.05 ng/ml IL-1 α and 5 ng/ml OSM (I/O ▲) for 21 days. Culture supernatants were removed and replaced with fresh treatments as required. The amounts of hydroxyproline in the culture supernatants were determined and were compared to the total amount of hydroxyproline in the comparative gingival tissue. Data are presented as cumulative % hydroxyproline release from each gingival tissue piece at three time points (day 7, day 14, and day 21). OHP – hydroxyproline.

Table 7.1: Total amount of hydroxyproline is associated with hydroxyproline release and MMP activity from IL-1+OSM stimulated gingival tissue pieces

Gingival tissue from one donor was acquired after canine exposure surgery. Gingival tissue was washed, the epithelium removed by scalpel, and the resultant connective tissue dissected into small pieces (approximately 2 mm³). These tissue pieces were either cultured in SFM or stimulated with 0.05 ng/ml IL-1 α and 5 ng/ml OSM for 21 days. Culture supernatants were removed and replaced with fresh treatments as required. Hydroxyproline concentrations were assessed in culture supernatants and tissue digests. The total amount of hydroxyproline (μ g) in each gingival tissue sample was calculated by adding the amount of hydroxyproline in each culture supernatant and the amount remaining in the tissue at day 21. MMP activity in the culture supernatants was determined (Section 2.14). This table displays the total hydroxyproline for each gingival tissue piece, whether the tissue was stimulated with IL-1+OSM, % hydroxyproline release at day 21 and MMP activity (RFU/ μ g hydroxyproline) at day 21.

IL-1 +OSM	Total hydroxyproline (μ g)	hydroxyproline release at day 21 (%)	MMP activity (RFU/ μ g hydroxyproline)
-	91.64	6.2	28.8
-	168.99	6.5	14.1
-	19.29	50	172
+	30.47	61	251
+	25.92	72	493
+	21.52	48	242

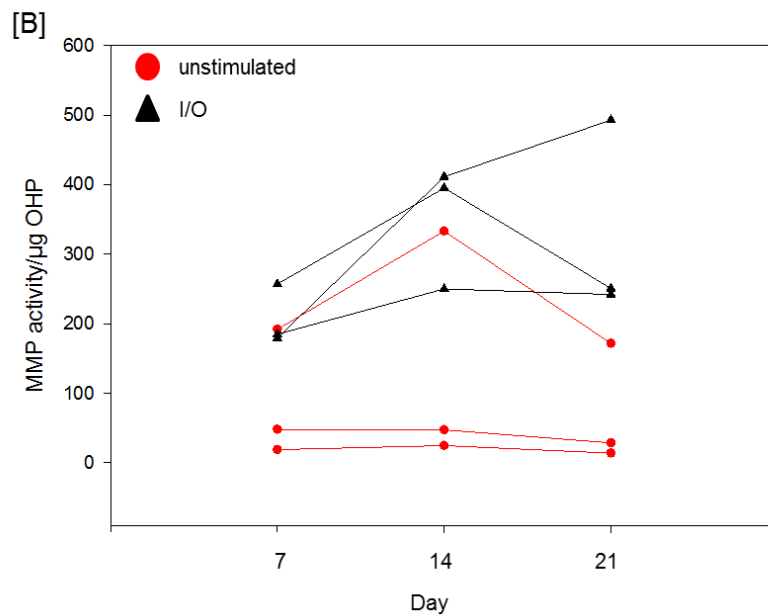
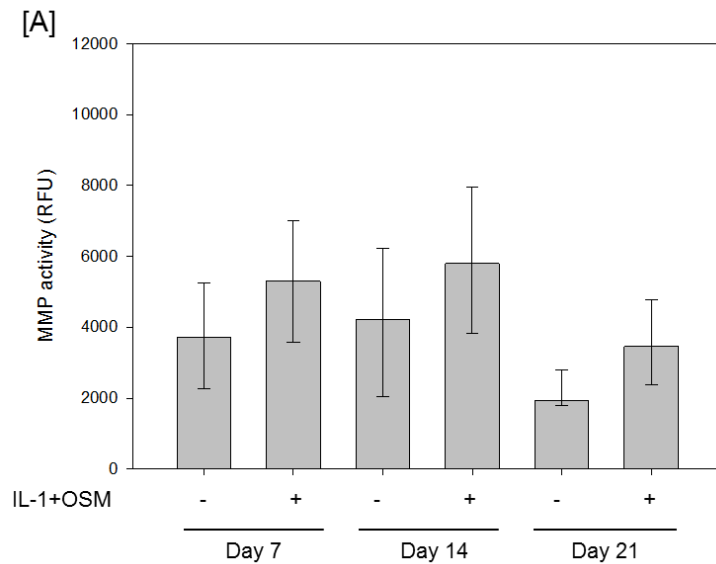

Figure 7.6: MMP activity in IL-1+OSM stimulated gingival tissue culture supernatants over time

Gingival tissue from one donor was acquired after canine exposure surgery. Gingival tissue was washed, the epithelium removed by scalpel, and the resultant connective tissue dissected into small pieces. These tissue pieces were either cultured in SFM or stimulated with 0.05 ng/ml IL-1 α and 5 ng/ml OSM for 21 days. Culture supernatants were removed and replaced with fresh treatments as required. MMP activity in the culture supernatants was determined (Section 2.14). [A] Data (RFU) are presented as median+IQR (n=3) at three time points (days 7, 14 and 21). Statistics: Mann-Whitney U test. [B] Data (MMP activity in RFU) are presented per μ g hydroxyproline in an effort to take account of the different tissue piece sizes. Unstimulated - \bullet , IL-1 α +OSM (I/O) - \blacktriangle . The results for each individual piece of tissue are displayed at three time points (days 7, 14 and 21). OHP – hydroxyproline.

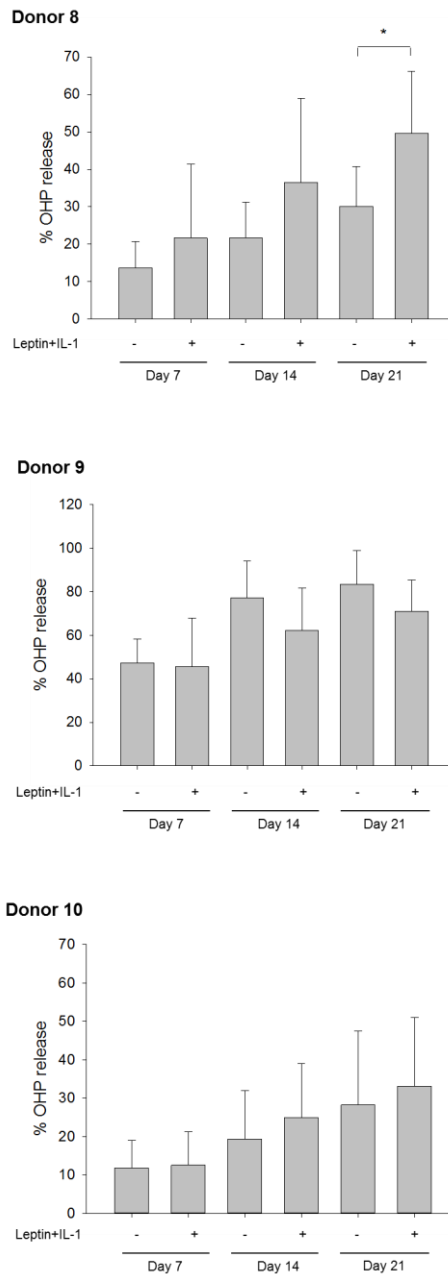

Figure 7.7: Cumulative hydroxyproline release from leptin+IL-1 stimulated gingival tissue explants over time.

Gingival tissue (from donors 8-10 as indicated) was acquired after canine exposure surgery. Gingival tissue was washed, the epithelium removed by scalpel, and the resultant connective tissue dissected into small pieces. These tissue pieces were either cultured in SFM or stimulated with 10 $\mu\text{g}/\text{ml}$ leptin and 0.05 ng/ml IL-1 α for 21 days. Culture supernatants were removed and replaced with fresh treatments as required. The amounts of hydroxyproline in the culture supernatants were determined and were compared to the total amount of hydroxyproline in the comparative gingival tissue. Data (mean+SD, donor 8 and 10 n=5/6, donor 9 n=5) are presented as cumulative % hydroxyproline release from gingival tissue at three time points (day 7, day 14, day 21). Statistics: T tests for independent samples: *=p<0.05 as indicated. OHP – hydroxyproline.

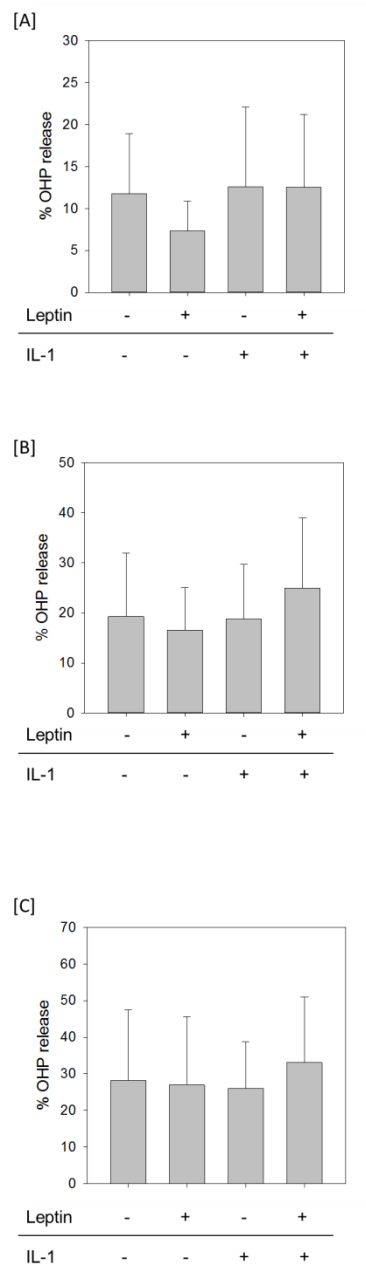
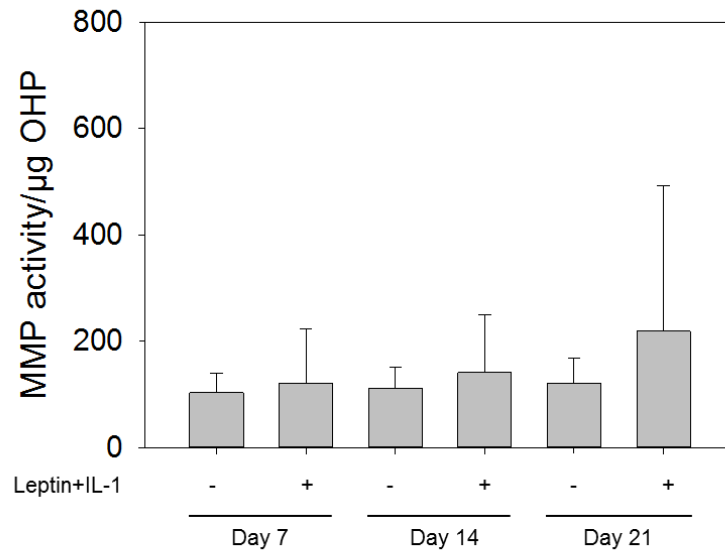

Figure 7.8: Cumulative hydroxyproline release from leptin+IL-1 stimulated gingival tissue explants.

Gingival tissue from one donor was acquired after canine exposure surgery. Gingival tissue was washed, the epithelium removed by scalpel, and the resultant connective tissue dissected into small pieces. These tissue pieces were either cultured in SFM or stimulated with leptin (10 $\mu\text{g}/\text{ml}$), IL-1 α (0.05 ng/ml) or leptin+IL-1 α (leptin 10 $\mu\text{g}/\text{ml}$, IL-1 α 0.05 ng/ml) for 21 days. Culture supernatants were removed and replaced with fresh treatments as required. The amounts of hydroxyproline in the culture supernatants were determined and were compared to the total amount of hydroxyproline in the comparative gingival tissue. Data (mean+SD, n=5) are presented as cumulative % hydroxyproline release from gingival tissue at [A] day 7, [B] day 14 and [C] day 21. Statistics: T tests for independent samples. OHP – hydroxyproline.

Donor 8



Donor 9

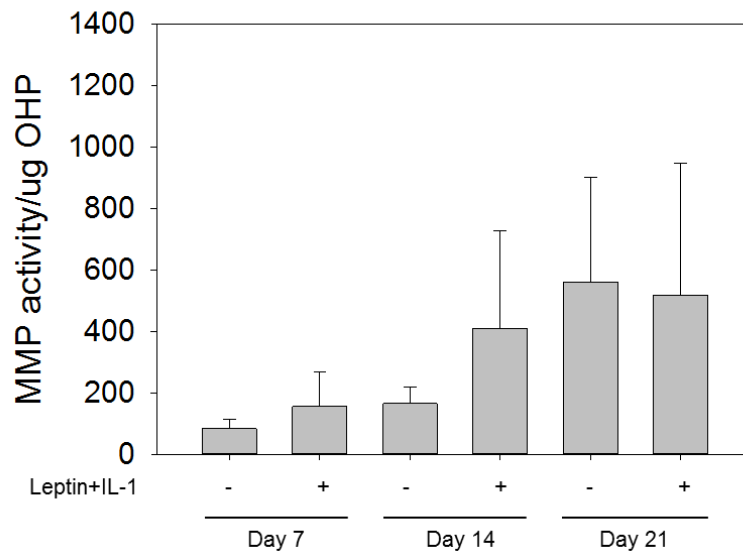

Figure 7.9: MMP activity in gingival tissue culture supernatants after stimulation with leptin and IL-1.

Gingival tissue (from donor 8 and donor 9 as indicated) was acquired after canine exposure surgery. Gingival tissue was washed, the epithelium removed by scalpel, and the resultant connective tissue dissected into small pieces. These tissue pieces were either cultured in SFM or stimulated with 10 µg/ml leptin and 0.05 ng/ml IL-1 α for 21 days. Culture supernatants were removed and replaced with fresh treatments as required. MMP activity in the culture supernatants was determined measuring the cleavage of a fluorescent MMP substrate. Data (mean+SD, donor 8 n=5/6, donor 9 n=5) are presented as MMP activity (RFU) per µg hydroxyproline at three time points (days 7, 14 and 21). OHP – hydroxyproline.

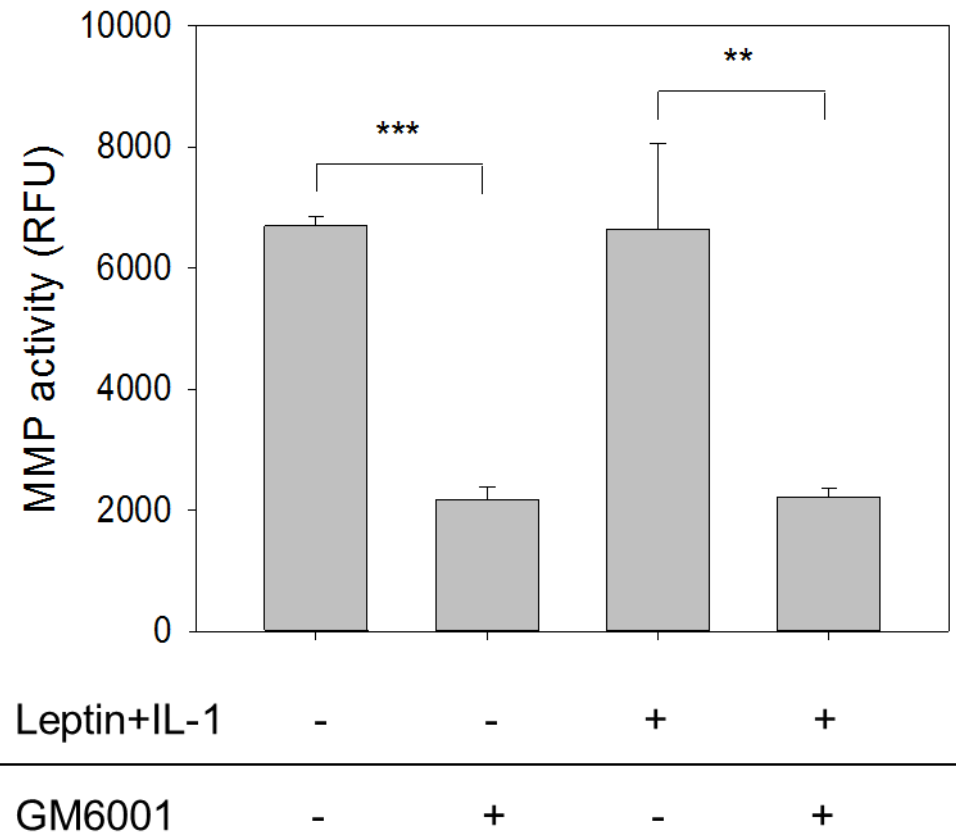

Figure 7.10: MMP activity in gingival tissue culture supernatants after stimulation with leptin+IL-1 and treatment with GM6001.

Gingival tissue from one donor was acquired after canine exposure surgery. Gingival tissue was washed, the epithelium removed by scalpel, and the resultant connective tissue dissected into small pieces. These tissue pieces were either cultured in SFM or stimulated with 10 $\mu\text{g/ml}$ leptin and 0.05 ng/ml IL-1 α for 3 days in the absence or presence of the MMP inhibitor GM6001 (10 μM). MMP activity in the culture supernatant was determined measuring the cleavage of a fluorescent MMP substrate. Data (MMP activity in RFU) are presented as mean+SD (n=3). Statistics: T tests for independent samples (Bonferroni-corrected): **=p<0.01, ***=p<0.001 as indicated.

8 Chapter 8. Discussion

The prevalences of obesity and T2DM are increasing at an alarming rate globally, presumably due to changes in lifestyle and diet (Malik *et al.*, 2013). Obese and T2DM populations are at risk of developing co-morbidities, including conditions associated with destructive chronic inflammation such as periodontitis (Hotamisligil, 2006; Pischon *et al.*, 2007; Preshaw *et al.*, 2012). Circulating levels of the hormone leptin are often elevated in individuals who are obese or have T2DM (Coppari and Bjorbaek, 2012). Aside from functioning as a hormone, there is strong evidence that leptin can promote immune and inflammatory responses (Matarese *et al.*, 2005).

The periodontium has a unique anatomy, and its exterior is constantly exposed to microbes (Bartold and Narayanan, 2006). It is for these reasons that the chronic inflammatory condition gingivitis is so common. The prevalence of periodontitis is increasing, and current treatment options are rarely fully successful (Newman *et al.*, 2011; White *et al.*, 2011). Fibroblasts are implicated in regulating the switch between acute and chronic inflammation by promoting leukocyte survival and retention in inflamed tissues (Buckley *et al.*, 2001; Buckley, 2011). Fibroblasts within the periodontium are immunocompetent cells implicated in the pathogenesis of periodontitis, due to their ability to regulate ECM remodelling and the production of inflammatory mediators (Bartold and Narayanan, 2006) (Section 1.11). Instead of regulating the switch between acute and chronic inflammation, could it be possible that gingival fibroblasts regulate the switch between the resolvable, self-limiting inflammatory responses of gingivitis to the irreversible, unstable and destructive inflammatory responses of periodontitis? In this study, it was hypothesised that leptin is a molecular link between obesity, T2DM and periodontitis by promoting inflammatory responses in gingival fibroblasts.

This study has shown that leptin (alone and synergistically with IL-1) enhanced the expression of a range of MMPs, chemokines and other immune mediators by gingival fibroblasts. Additionally, and for the first time, it was shown that leptin synergised with a TLR2 agonist to increase the production of MMPs by gingival fibroblasts. Leptin-stimulated gingival fibroblasts activated multiple intracellular signalling pathways, but it was the MAPK pathway, and ERK in particular, which were required for leptin (+IL-1 or pam2CSK4) mediated MMP-1 expression. A gingival tissue explant model was developed in an effort to assess leptin+IL-1 stimulated collagen degradation; however, at present this model proved to be unsuitable for addressing this aim.

Two interesting questions arise from these findings: why do gingival fibroblasts express the leptin receptor, and what is the purpose of their response to leptin? I hypothesise that gingival fibroblasts express the leptin receptor because they need to be informed of the energy status of the organism in which they reside, and that their response to leptin regulates the structure and function of the gingival connective tissue in line with energy availability (Figure 8.1). Essentially, if energy resources are abundant (and therefore leptin levels are high) gingival fibroblasts can function effectively to maintain the structural integrity and immunocompetence of the gingival connective tissue. In contrast, if energy resources are depleted (and therefore leptin levels are low) gingival fibroblasts do not receive a signal to optimally maintain the structural integrity and immunocompetence of the gingival connective tissue. These functions which gingival fibroblasts regulate require energy which the organism needs to utilise elsewhere. Finally, I hypothesise that the presence of leptin in the inflamed gingiva will enhance inflammatory gingival fibroblast responses, and that this will dose-dependently increase the risk of developing periodontitis.

There is much evidence that gingival fibroblasts regulate the structural integrity of the gingiva (discussed in chapters 3, 4, and 6). Similarly, it is not a new concept that gingival fibroblasts are immunocompetent cells (discussed in chapter 6); for example, class II MHC molecules are induced on the surface of gingival fibroblasts by cytokines (Mahanonda *et al.*, 2008). As such, gingival fibroblasts, and indeed fibroblasts at other anatomical locations, are no longer thought of as inert cells whose only function is to produce and remodel ECMs (Section 1.11). Fibroblasts actively monitor their environment, and respond to changes in an integrated manner, as evidenced by this and other studies (Mahanonda *et al.*, 2007; McGettrick *et al.*, 2009; Mia *et al.*, 2014). This supports the idea that leptin affects a range of responses in gingival fibroblasts. It has been difficult to pinpoint the roles of fibroblasts in health and disease due to the lack of consistency regarding the characteristics of these cells (Naylor *et al.*, 2012); a problem possibly mediated by their functional plasticity. Nonetheless, a recent study did find that resistance to a chemotherapy drug is mediated by fibroblasts (Sun *et al.*, 2014). In this study, human cancer-associated fibroblasts were genetically modified (stable knockdown of IL-6) *ex vivo* before being grafted into mice with cells of a human breast cancer line. Sun *et al.* (2014) determined that fibroblast-derived IL-6 mediated resistance to the chemotherapy drug tamoxifen. A more comprehensive understanding of gingival fibroblast function could help to elucidate the pathogenesis of periodontitis,

explain why existing treatments are not entirely effective, and even identify novel therapeutic targets.

Many different cell types, including gingival fibroblasts (Section 1.11.6), express the leptin receptor, and respond to leptin (Tartaglia *et al.*, 1995; Sanchez-Margalet *et al.*, 2003). What is striking is the variety of responses that leptin can regulate. For example, leptin regulates leukocyte proliferation (Sanchez-Margalet *et al.*, 2003), the production of molecules involved in ECM remodelling by fibroblasts (Schram *et al.*, 2011), the production of neuropeptides by neurones (Cohen *et al.*, 2001), and fatty acid oxidation in muscle (Minokoshi *et al.*, 2002). What is interesting is that these leptin-stimulated responses are among the expected responses of these cells (e.g. leptin stimulates neuropeptide production in neurones (Cohen *et al.*, 2001), but did not in gingival fibroblasts in this study). This suggests that leptin enhances the diverse specialised responses of different cell types, and may explain the wide-ranging defects in humans with extremely low or absent leptin (Clement *et al.*, 1998; Farooqi *et al.*, 2002). It is already clear that leptin mediates the physiological adjustments that reduce metabolism as part of the starvation response (Kelesidis *et al.*, 2010); however, much of this research has focussed on metabolism at the level of the whole organism. At a fundamental level, all cellular responses require and utilise energy in the form of ATP. It seems a logical progression from this that during periods of starvation, energy consumption is also reduced on a cellular level, and that this is also controlled by leptin. This could explain the diverse responses that leptin regulates, and in particular support the hypothesis that leptin acts to inform gingival fibroblasts of systemic energy levels.

As previously mentioned, gingival fibroblast responses depend on the stimuli these cells are exposed to. For example, in this study IL-1 stimulated the differential expression of a large number of genes in gingival fibroblasts compared to unstimulated cells (Section 6.3.5); additionally, leptin synergistically enhanced the expression of a number of those genes differentially expressed in gingival fibroblasts stimulated with IL-1. However, this response enhancement does not appear to be a feature unique to fibroblasts. Leptin enhances LPS-mediated TNF- α production by monocytes, but does not elicit this response in the absence of LPS (Jaedicke *et al.*, 2013). Similarly, leptin enhances the proliferation of activated T cells, but cannot initiate T cell activation (Martin-Romero *et al.*, 2000). This suggests that leptin has a permissive effect on cells under co-existing stimulatory conditions, and in particular supports the hypothesis that leptin enhances inflammatory responses in gingival fibroblasts.

Starvation is associated with a degree of immunodeficiency (Lord *et al.*, 1998). Leptin promotes many processes relevant to inflammation, including the clearance of infections (Hsu *et al.*, 2007), wound healing (Umeki *et al.*, 2014), leukocyte infiltration (Vernooy *et al.*, 2010), and ECM remodelling (Hui *et al.*, 2012). Therefore, low levels of leptin are thought to be one mechanism that determines immunodeficiency during starvation, and evidence for this on a cellular level is starting to be generated (Saucillo *et al.*, 2014). Inflammation and immune responses are complex processes involving a number of cell types, and as such require high levels of energy expenditure (Muehlenbein *et al.*, 2010). This indicates that inflammatory responses are regulated in leptin-responsive cells to ensure that they occur at a level that can be supported by the available systemic energy stores. A comprehensive understanding of the functions of leptin on fibroblasts in the gingiva and elsewhere is important, because modulation of leptin has been utilised clinically, and remains a viable option for treating several conditions (most notably Type 1 diabetes mellitus and lipodystrophy) (Kelesidis *et al.*, 2010) (Section 1.3). The wide-ranging cellular targets of leptin action, and the context-dependent responses, could affect the efficacy and safety of leptin as a therapeutic target.

In developed countries starvation (and therefore leptin deficiency) is rare. In contrast, the rapidly increasing obese (and T2DM) populations in developing countries indicates that there is an increasing population of hyperleptinaemic individuals (Malik *et al.*, 2013). There is much evidence (including the results regarding gingival fibroblasts in this study) that leptin regulates cellular responses in a dose-dependent manner (Cao *et al.*, 2007; Tong *et al.*, 2008; Kato *et al.*, 2011). For example, high concentrations of leptin stimulate higher production of cytokines and MMPs in mesenchymal cells than lower concentrations of leptin; this dose-dependent effect is also evident in the presence of IL-1 (Hui *et al.*, 2012) (Chapters 3 and 4). This suggests that inflammatory mesenchymal cell responses are enhanced during hyperleptinaemia, and supports the original hypothesis in this study that leptin-stimulated inflammatory responses in gingival fibroblasts are mechanistically relevant to the increased risk of periodontitis in individuals who are obese or have T2DM.

In opposition to this, leptin resistance occurs in conditions of hyperleptinaemia (Section 1.3). Our understanding of leptin resistance is mainly based on *in vivo* comparisons of diet-induced obesity to healthy counterparts (Kelesidis *et al.*, 2010; Mantzoros *et al.*, 2011), and suggests that there is a threshold concentration of leptin above which leptin

signalling is saturated. However, differences in intracellular signalling pathway activation and biological exposure to leptin are implicated in a differential susceptibility to leptin resistance between different types of neurones (Münzberg *et al.*, 2004; Coppari and Bjorbaek, 2012). There is evidence that leptin resistance can be somewhat corrected by dietary and therapeutic interventions (Roth *et al.*, 2008; Kelesidis *et al.*, 2010), suggesting that leptin resistance is not permanent. Finally, the ability for leptin to regulate energy metabolism and insulin sensitivity are differentially affected by leptin resistance (Coppari and Bjorbaek, 2012), which suggests that different functions regulated by leptin are not identically affected by leptin resistance. Together, this suggests that the threshold concentration for saturation of leptin signalling varies between cell types, anatomical niches, and functional responses. Therefore, it cannot be assumed that gingival fibroblasts are resistant to leptin under similar conditions to those which induce resistance in other cells types. Further studies are warranted to investigate leptin sensitivity and resistance in the gingiva during health and disease, in an effort to confirm whether leptin is relevant to the increased risk of periodontitis in the growing population of obese and T2DM (hyperleptinaemic) individuals.

In conclusion, the results presented in this thesis have greatly added to the current data regarding the role of leptin on fibroblasts in the gingiva. Specifically, it was shown that leptin enhances wide-ranging inflammatory responses in gingival fibroblasts, alone and synergistically in combination with inflammatory mediators. These results support the hypothesis that leptin is a molecular link between obesity, T2DM and periodontitis by synergistically promoting deleterious inflammatory responses in gingival fibroblasts, but also indicate that leptin may have a physiological role in regulating homeostatic gingival fibroblast function.

8.1 Future work

One limitation regarding the results presented in this thesis is whether they are translatable to gingival fibroblast responses *in vivo*. An important area of future research would be to assess the functional relevance of leptin on inflammatory responses in gingival fibroblasts. For example, the use of transwell filters in a similar approach to McGettrick *et al.* (2010) could be used to assess whether leptin-stimulated gingival fibroblasts regulate leukocyte recruitment. Co-culture studies of gingival fibroblasts and leukocytes or epithelial cells, or the use of gingival fibroblast-conditioned media, could be used to determine whether leptin stimulated gingival fibroblasts affect leukocyte or epithelial cell survival, proliferation and differentiation. Further improvements to the *ex*

vivo gingival connective tissue explant system used in this study (e.g. precision cut slicing) may help to determine whether leptin-stimulated gingival fibroblasts play a role in gingival ECM degradation. Alternatively, human gingival (connective) tissue from individuals with periodontitis and healthy controls could be grafted onto severe combined immunodeficiency (SCID) mice in an effort to assess the responses of human gingival tissue to leptin without the problems encountered in *ex vivo* tissue culture (as discussed in Chapter 7). Although this would be a novel approach regarding gingival tissue, the technique of xenografting human tissue onto SCID mice has been utilised in the fields of cancer and rheumatoid arthritis to study human tissues in an *in vivo* setting (Morton and Houghton, 2007; Patel, 2010; Wythe *et al.*, 2013).

The results in this study indicated that leptin and OSM may regulate gingival fibroblast MMP production in the same manner (Chapter 4). It would be interesting to further investigate the similarity in gingival fibroblast responses stimulated by leptin and other IL-6 family cytokines to assess whether there is IL-6 family cytokine redundancy in gingival fibroblast responses. This could be assessed by genome-wide expression analysis in IL-1±IL-6/OSM stimulated gingival fibroblasts.

It would also be interesting to determine under what conditions gingival fibroblasts are resistant to leptin. To test whether gingival fibroblasts can become resistant to leptin *in vitro* gingival fibroblasts could be cultured over a longer time period with multiple exposures to leptin (and delayed stimulation with inflammatory mediators) prior to assessing gene expression and intracellular signalling responses.

Gingival fibroblasts, compared to fibroblasts from other anatomical sites, have a differential ability to remodel ECM (Mah *et al.*, 2014). Also, fibroblasts from distinct anatomical sites differ in their capacity to regulate immune and inflammatory responses (Buckley, 2011). It would be interesting to acquire and culture fibroblasts from other anatomical locations (e.g. synovium, skin, intestine) and to compare their responses to leptin with those of gingival fibroblasts.

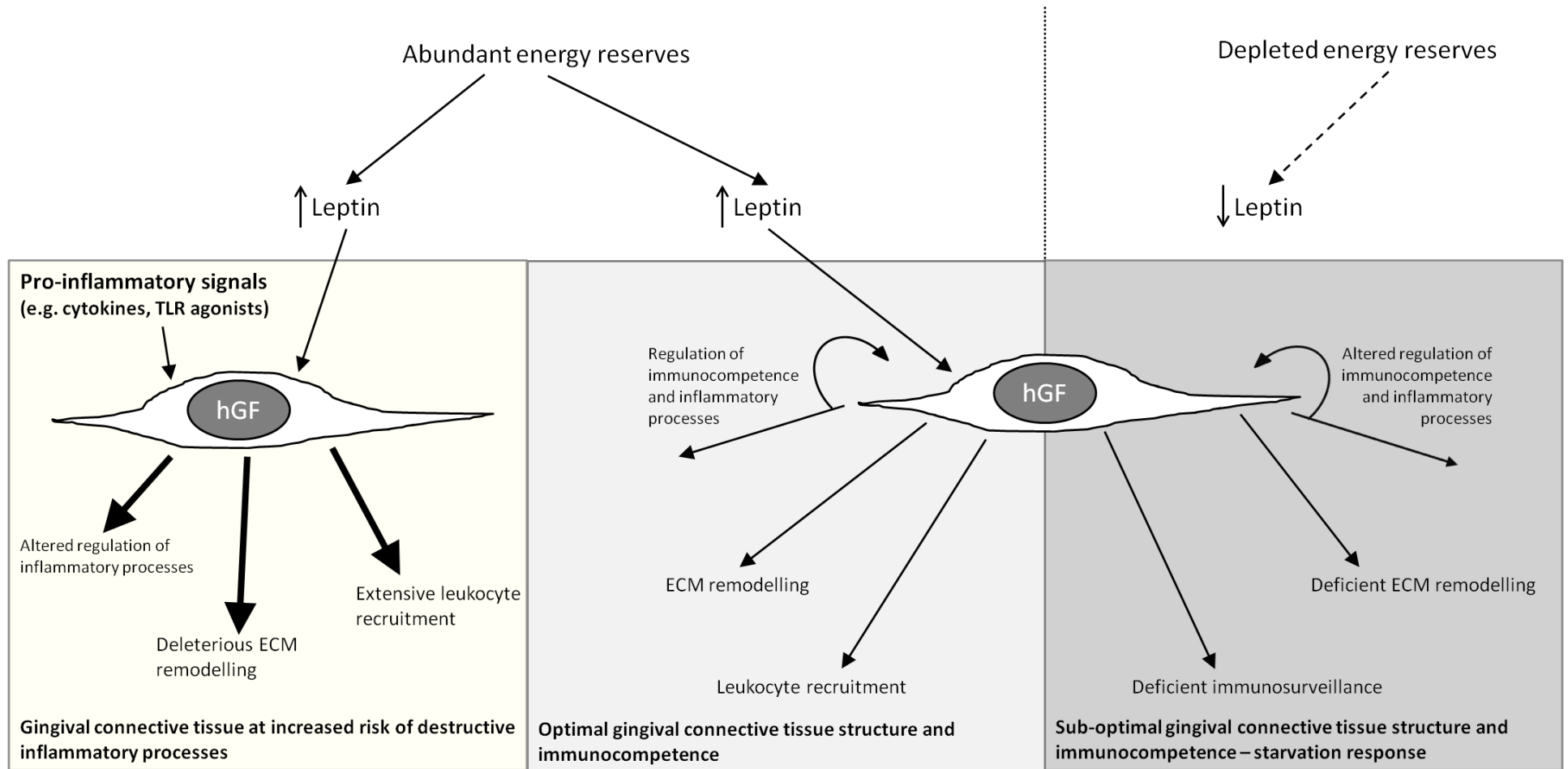
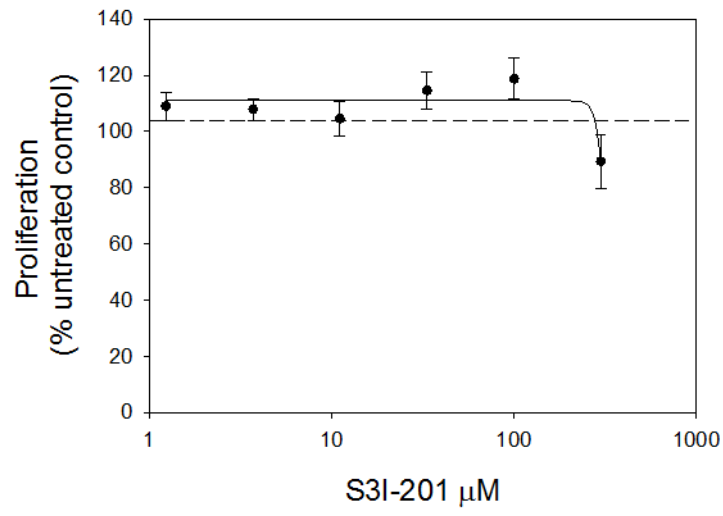

Figure 8.1: Schematic diagram illustrating the hypothetical role of leptin in regulating fibroblast function in the gingiva.

When energy reserves are abundant the circulating concentration of leptin will be high. Circulating leptin (or local sources of leptin e.g. gingival tissue adipocytes) may diffuse into the gingiva where it could bind the leptin receptor on gingival fibroblasts, thereby signalling the level of systemic energy stores. The response to leptin signalling in hGFs may affect ECM remodelling, leukocyte recruitment, and immunocompetence and inflammatory processes of both fibroblasts and other cells in the gingiva. If energy reserves are depleted, the circulating concentration of leptin will be low. In this instance lower amounts of leptin will bind to the leptin receptor on hGFs, possibly resulting in deficiencies in the structure and immunocompetence of the gingival connective tissue. This could be a peripheral feature of starvation. When gingival fibroblasts are exposed to leptin in the presence of pro-inflammatory signals, the inflammatory responses stimulated are enhanced. This could enhance the risk of destructive inflammation as observed in periodontitis. hGF – human gingival fibroblast.

A. Appendix A. The effect of chemical signalling pathway inhibitors on hGF proliferation.

A



B

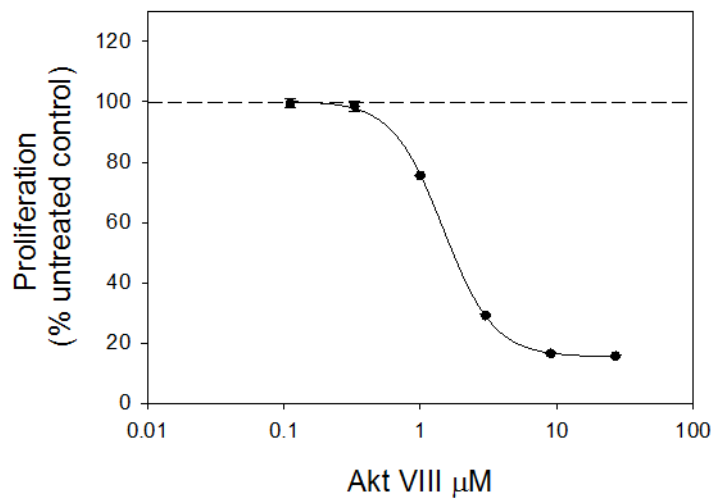

C

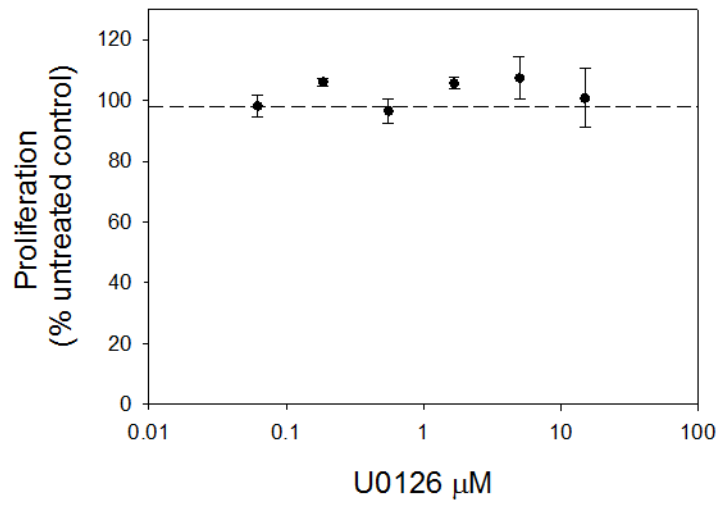

D

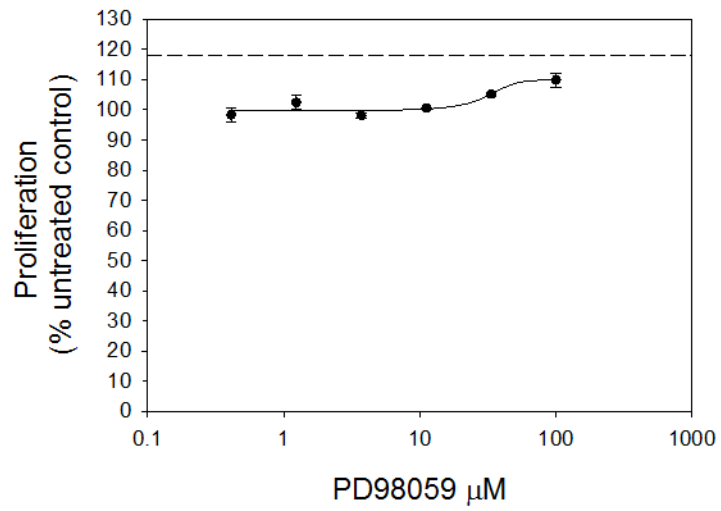

F

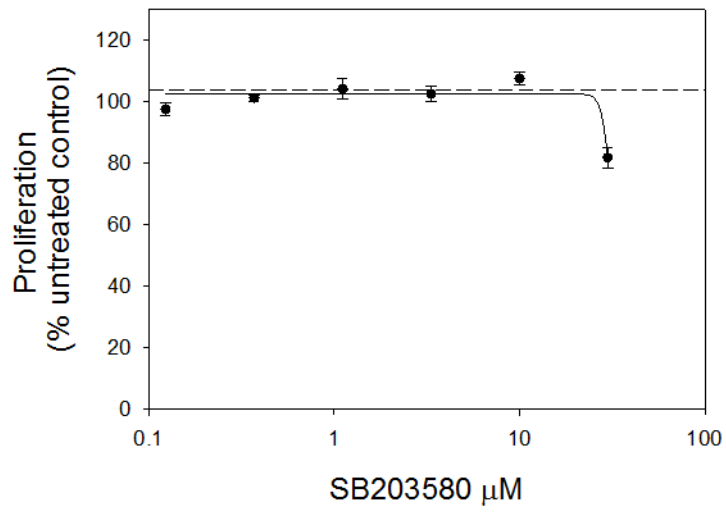

F

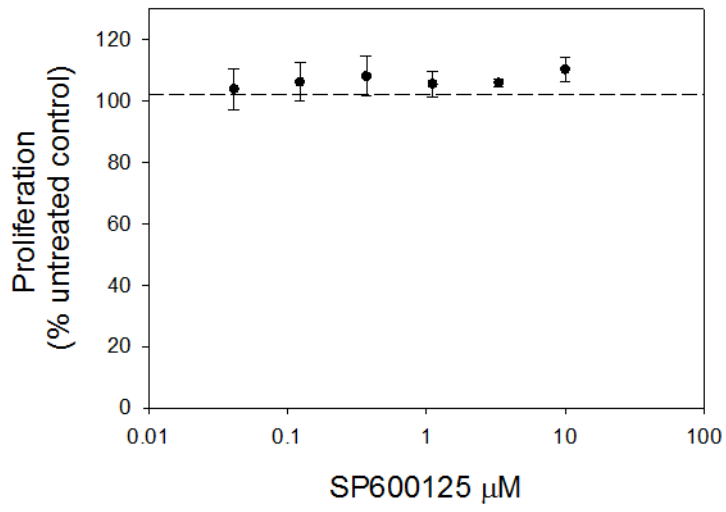

G

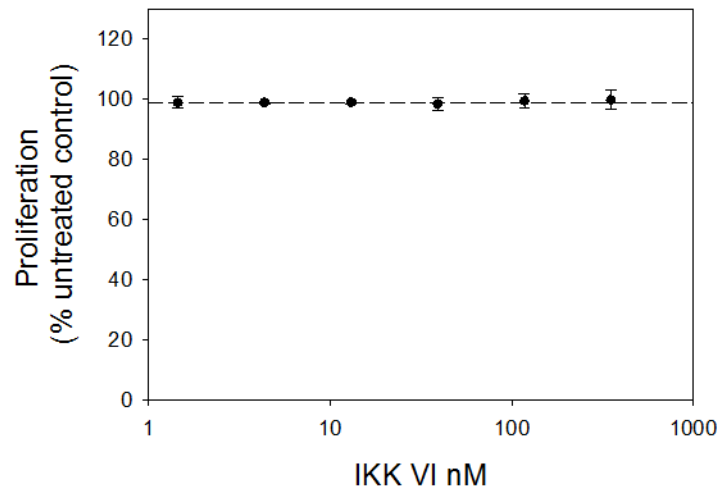

H

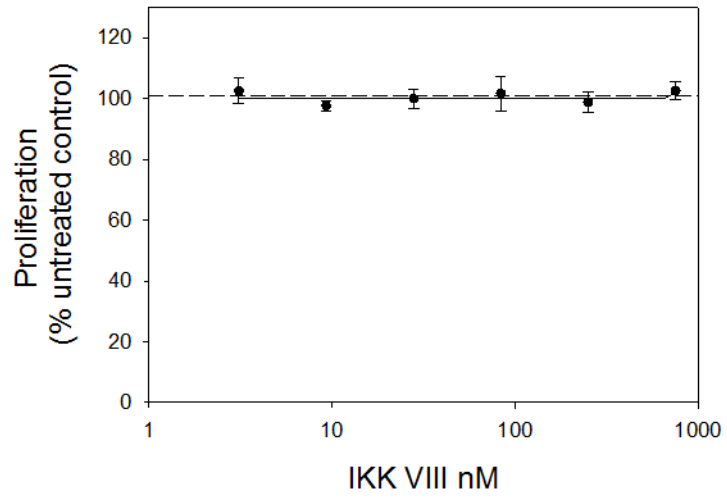

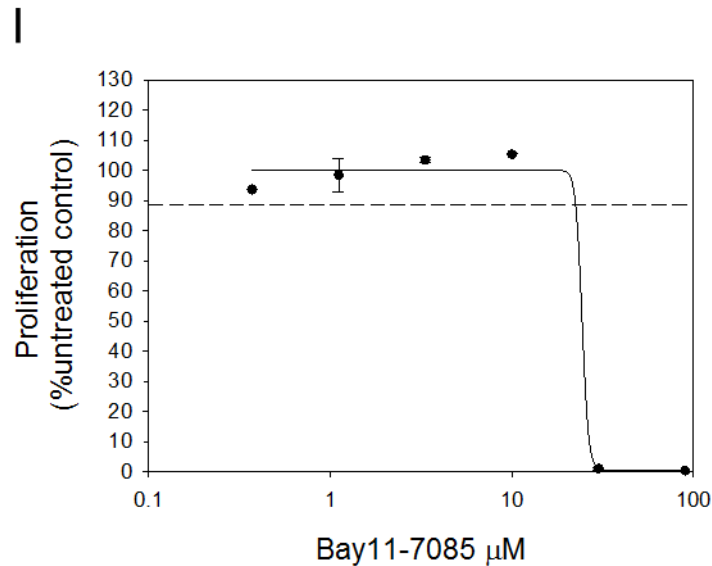
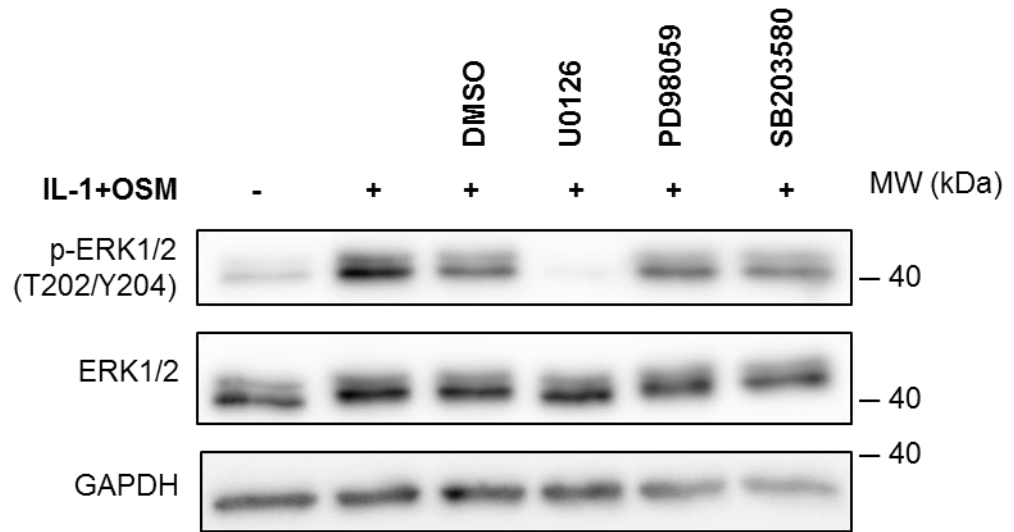

Figure A.1: Dose response relationships between signalling pathway inhibitors and hGF proliferation.

hGFs (n=2) were treated for 24 h with a 3-fold dilution series of [A] STAT3 inhibitor S3I-201 (top concentration: 300 µM), [B] Akt inhibitor VIII (top concentration: 27 µM), [C] MEK inhibitor U0126 (top concentration: 15 µM), [D] MEK inhibitor PD98059 (top concentration: 100 µM), [E] p38 inhibitor SB203580 (top concentration: 30 µM), [F] JNK inhibitor SP600125 (top concentration: 10 µM), [G] IKK inhibitor VI (top concentration: 351 nM), [H] IKK inhibitor VIII (top concentration: 750 nM) and [I] IκB inhibitor Bay11-7085 (top concentration: 90 µM). hGF proliferation was assessed using a colourimetric assay (Section 2.5.1). hGF proliferation is expressed as % untreated control. A 4PL curve was fitted to the dose-response data except for U0126, SP600125 and IKK VI where no fits could be made. The dashed horizontal line displayed represents the proliferation observed for hGFs treated with a concentration of DMSO \geq the highest concentration of DMSO in inhibitor-treated hGFs.

B. Appendix B. The effect of chemical signalling pathway inhibitors on intracellular signalling in hGFs.

A



B

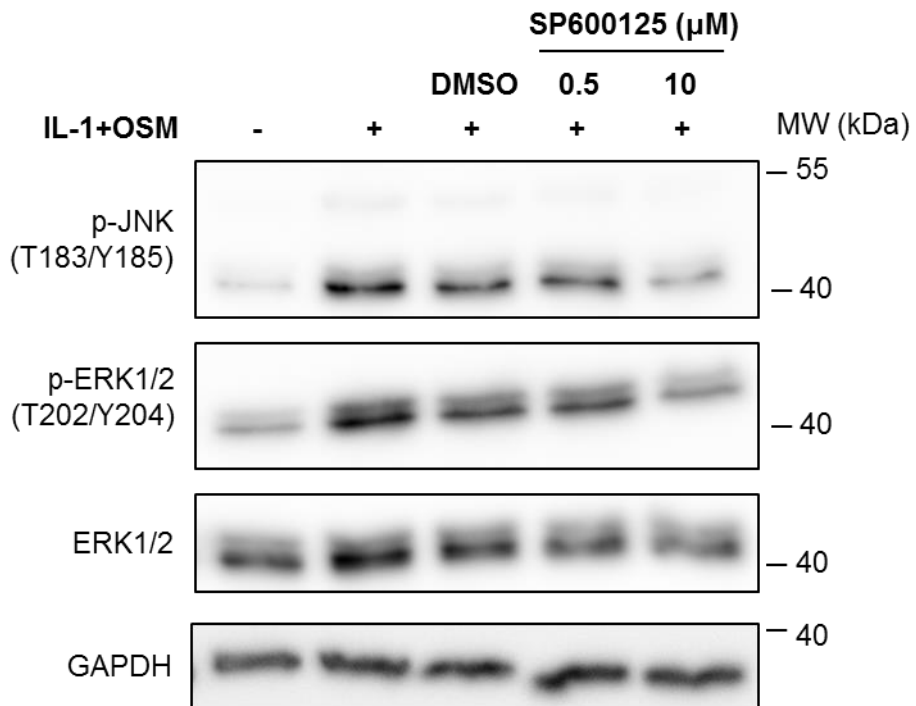

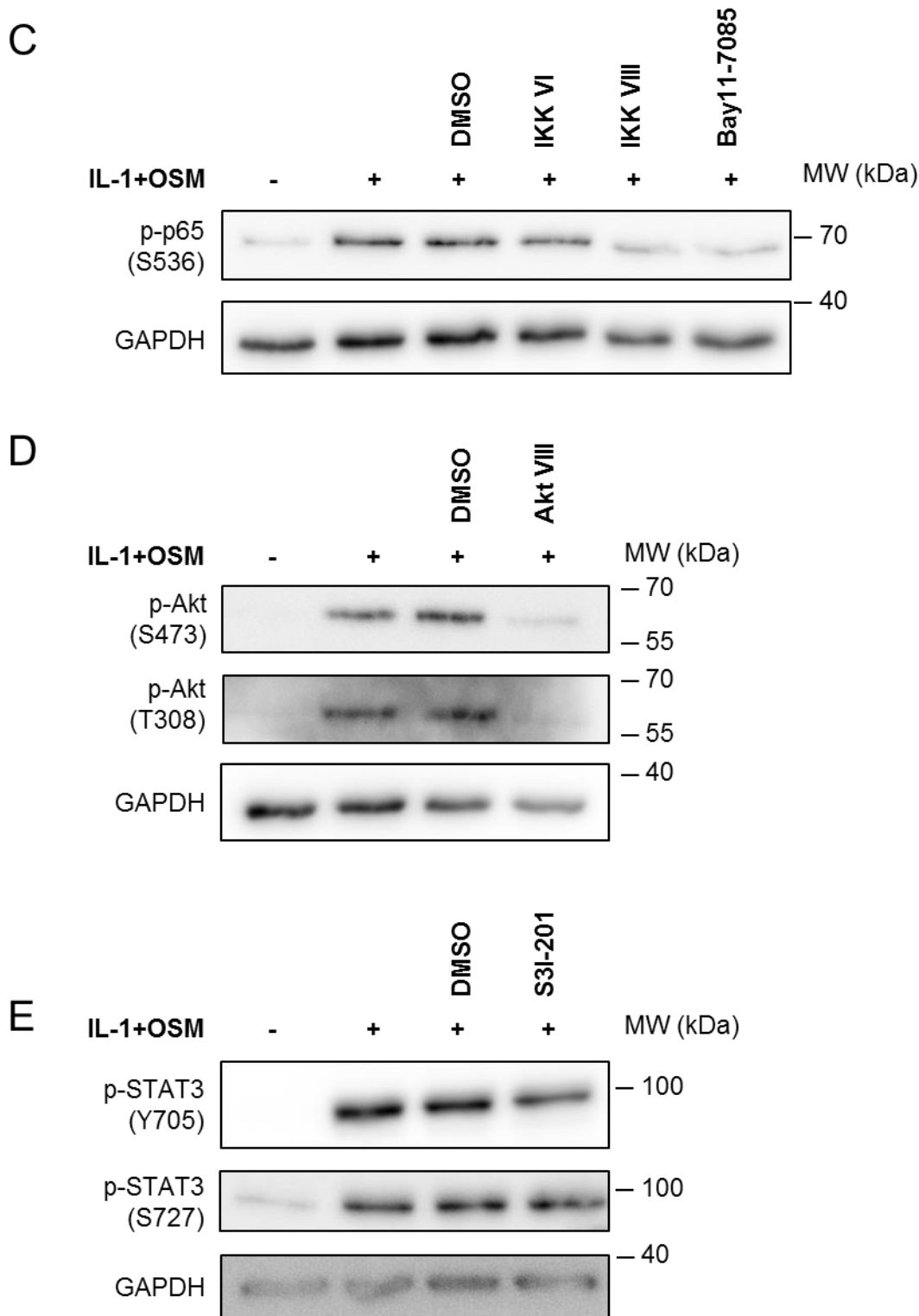

Figure B.1: Chemical inhibition of the phosphorylation of signalling pathway intermediates.

hGFs were stimulated with IL-1 α +OSM for 20 min. Prior to stimulation, hGFs were pre-treated for 30 min with DMSO or chemical pathway inhibitors: [A] 10 μ M U0126, 10 μ M PD98059 or 10 μ M SB203580, [B] 0.5 μ M or 10 μ M SP600125, [C] 300 nM IKK VI, 700 nM IKK VIII or 10 μ M Bay11-7085, [D] 300 nM Akt VIII, [E] 100 μ M S3I-201. Lysates were prepared from hGFs and proteins (as labelled) were resolved by SDS-PAGE and immunoblotting. GAPDH was used as a loading control.

C. Appendix C. Real-time RT-PCR.

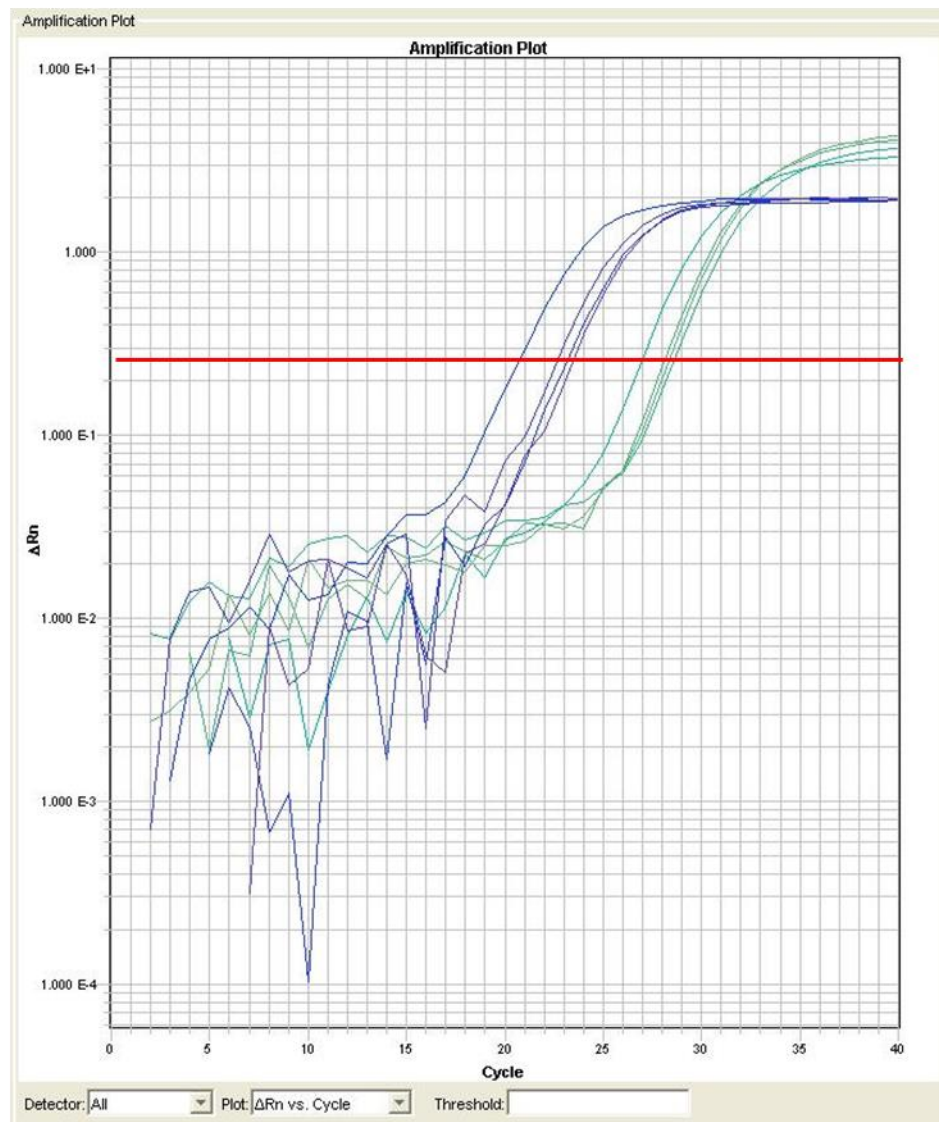
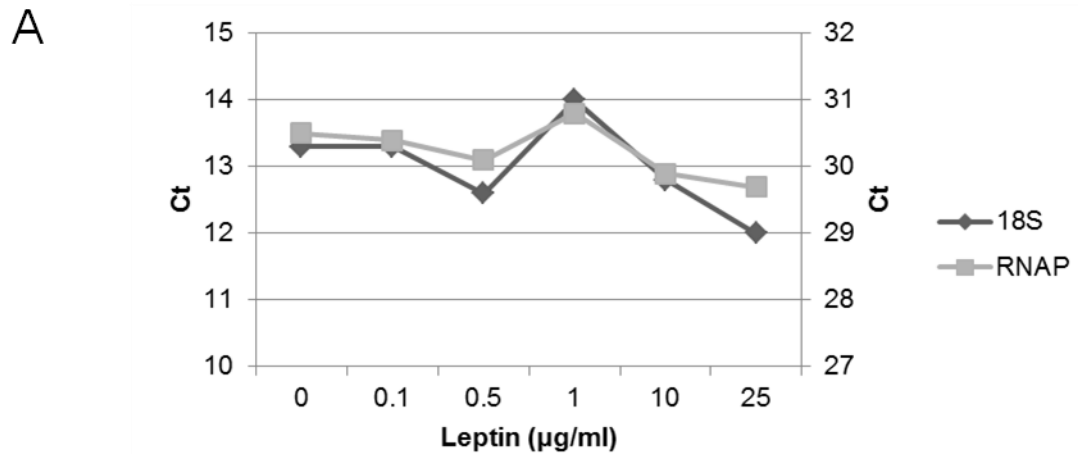

Figure C.1: A representative amplification plot for real-time RT-PCR analysis.

The magnitude of detected fluorescence (ΔRn) was plotted against PCR cycle number. In this plot the dark blue lines represent detection of MMP-1 while the green lines represent RNA polymerase II. A threshold (horizontal line shown in red) is fitted to cross each curve during the exponential phase of amplification. The cycle number where this threshold crosses the amplification curve (C_t) is used for relative gene expression analysis.



B

Leptin (µg/ml)	18S			RNAP		
	Mean (Ct)	SD	% cv	Mean (Ct)	SD	% cv
0	13.3	0.245	2	30.5	0.376	1
0.1	13.3	0.407	3	30.4	0.389	1
0.5	12.6	0.298	2	30.1	0.420	1
1	14.0	1.07	8	30.8	1.00	3
10	12.8	0.242	2	29.9	0.384	1
25	12.0	0.784	7	29.7	0.739	2
	Combined 18S			Combined RNAP		
Mean (Ct)	13.0			30.2		
SD	0.710			0.414		
% cv	5			1		

Figure C.2: Comparison of 18S rRNA and RNAP gene expression in hGFs.

hGFs were stimulated with leptin (0 - 25 µg/ml) for 24 hours. hGFs were lysed in preparation for reverse transcription to generate cDNA. Real-time RT-PCR was performed to assess 18S rRNA and RNAP gene expression. [A] Data (n=4) are presented as mean C_t values. 18S C_t values (\diamond) are plotted against the left y-axis, while RNAP C_t values (\square) are plotted against the right y-axis. [B] Data (n=4) are presented as mean C_t values for 18S and RNAP at each leptin concentration, and in combination (mean C_t for all leptin concentrations). The standard deviation and % CV are also displayed. RNAP – RNA polymerase II, C_t – threshold cycle, SD – standard deviation, cv – coefficient of variance.

D. Appendix D: The human immune panel TLDA.

Table D.1: List of genes on the human immune panel TLDA.

The assay ID (Life Technologies) indicates the specific primer/probe used for each gene. Reference genes are highlighted in bold.

Assay ID	Gene Symbol	Assay ID	Gene Symbol
Hs00174092 m1	IL1A	Hs00163934 m1	CD40LG
Hs00174097 m1	IL1B	Hs00219575 m1	HLA-DRA
Hs00174114 m1	IL2	Hs99999917 m1	HLA-DRB1
Hs00174117 m1	IL3	Hs00203436 m1	TBX21
Hs00174122 m1	IL4	Hs00188346 m1	TNFRSF18
Hs00174200 m1	IL5	Hs00359999 m1	ICOS
Hs00174131 m1	IL6	Hs00167248 m1	NOS2A
Hs00174202 m1	IL7	Hs00153350 m1	BCL2
Hs00174103 m1	IL8	Hs00169141 m1	BCL2L1
Hs00174125 m1	IL9	Hs00180269 m1	BAX
Hs99999901 s1	18S	Hs00164932 m1	ICAM1
Hs00174086 m1	IL10	Hs00174583 m1	SELP
Hs00168405 m1	IL12A	Hs00174057 m1	SELE
Hs00233688 m1	IL12B	Hs00157965 m1	HMOX1
Hs00174379 m1	IL13	Hs00153133 m1	PTGS2
Hs00174106 m1	IL15	Hs00166915 m1	REN
Hs00174383 m1	IL17	Hs00189742 m1	LRP2
Hs00155517 m1	IL18	Hs00411908 m1	MYH6
Hs00234142 m1	CCL3	Hs00192564 m1	RPL3L
Hs00171149 m1	CCL19	Hs00167927 m1	CYP1A2
Hs00234140 m1	CCL2	Hs00167982 m1	CYP7A1
Hs00174575 m1	CCL5	Hs00174143 m1	IFNG
Hs00174150 m1	CCR2	Hs00169473 m1	PRF1
Hs99999919 m1	CCR4	Hs00188051 m1	GZMB
Hs00152917 m1	CCR5	Hs00246266 m1	GNLY
Hs00171054 m1	CCR7	Hs00163653 m1	FAS
Hs00171041 m1	CXCR3	Hs00181225 m1	FASLG
Hs00171042 m1	CXCL10	Hs00171257 m1	TGFB1
Hs00171138 m1	CXCL11	Hs00232219 m1	SMAD3
Hs00174164 m1	CSF1	Hs00178696 m1	SMAD7
Hs00171266 m1	CSF2	Hs00161707 m1	SKI
Hs00357085 g1	CSF3	Hs00365052 m1	FN1
Hs00234174 m1	STAT3	Hs00166712 m1	COL4A5
Hs00174517 m1	NFKB2	Hs00163811 m1	C3
Hs00395088 m1	IKBKB	Hs00174128 m1	TNF
Hs00167894 m1	CD3E	Hs00236874 m1	LTA
Hs00181217 m1	CD4	Hs00174179 m1	ACE
Hs00233520 m1	CD8A	Hs00173626 m1	VEGF
Hs00174333 m1	CD19	Hs00156373 m1	CD34
Hs00166229 m1	IL2RA	Hs00241341 m1	AGTR1
Hs00174796 m1	CD28	Hs00169126 m1	AGTR2
Hs00233552 m1	CD38	Hs00174961 m1	EDN1
Hs00374176 m1	CD40	Hs00154837 m1	ECE1
Hs00365634 g1	PTPRC	Hs99999905 m1	GAPDH
Hs00154355 m1	CD68	Hs99999903 m1	ACTB
Hs00175478 m1	CD80	Hs99999911 m1	TFRC
Hs00199349 m1	CD86	Hs99999908 m1	GUSB
Hs00175480 m1	CTLA4	Hs99999906 m1	PGK1

[A]

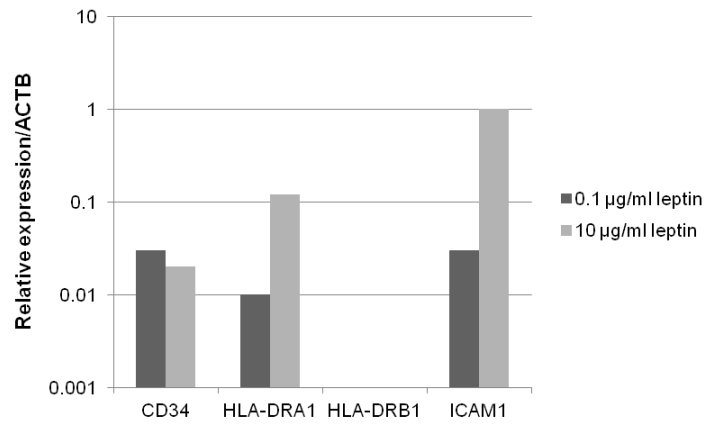

[B]

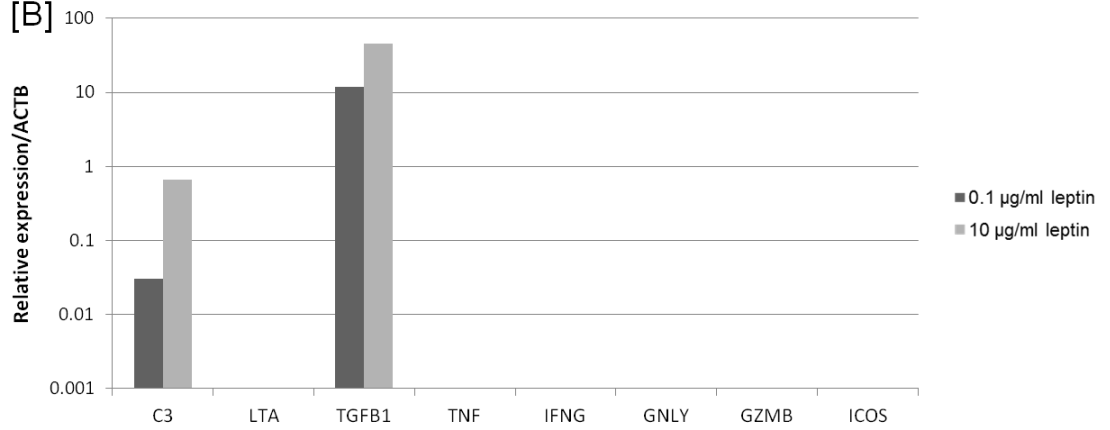

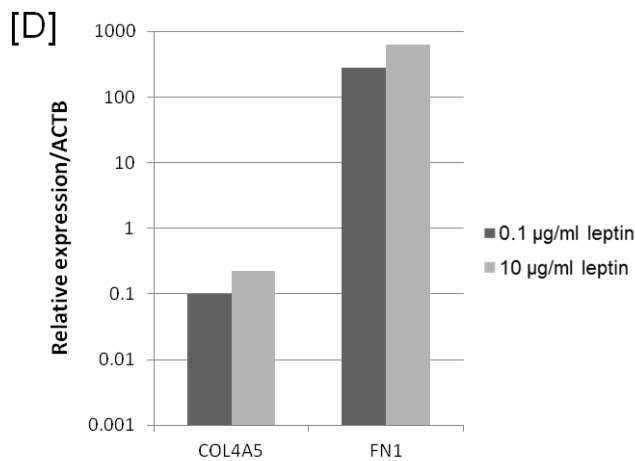
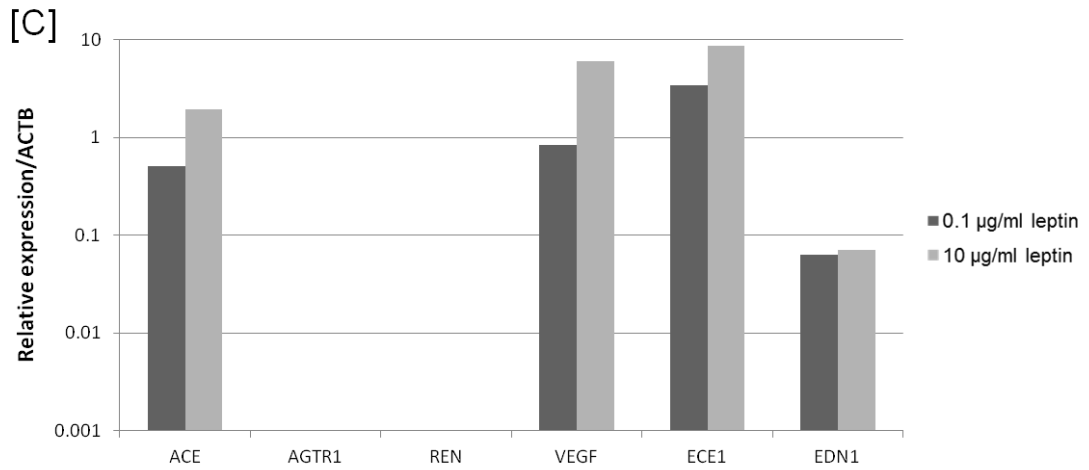
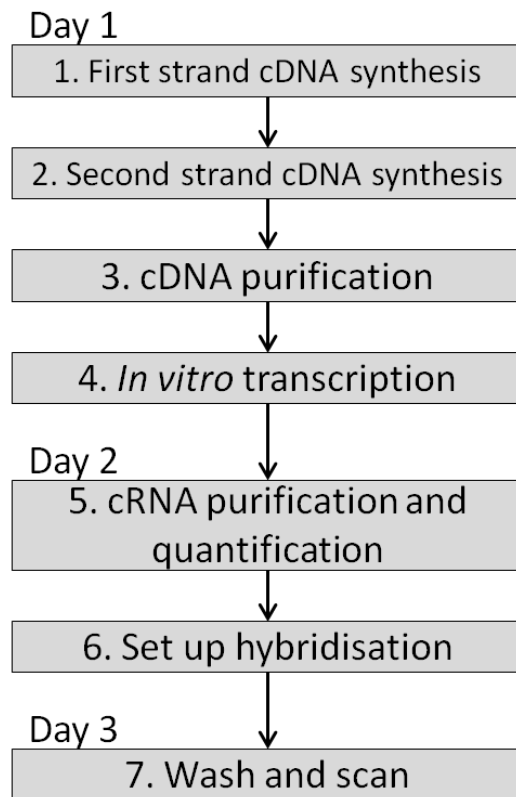

Figure D.1: Expression of selected genes on the immune TLDA in leptin-stimulated hGFs.

hGFs were stimulated with 0.1 or 10 µg/ml leptin for 24 h. Cells were lysed and cDNA was prepared by reverse transcription. cDNA was loaded onto a human immune panel TLDA and gene expression was determined by real-time RT-PCR. Relative gene expression was determined by normalising to the reference gene β -actin. [A] Cell surface markers, [B] regulators of inflammation and immunity, [C] regulators of vascular function, [D] ECM components.

E. Appendix E. Human HT-12 v4 genome-wide expression beadchip.

A



B

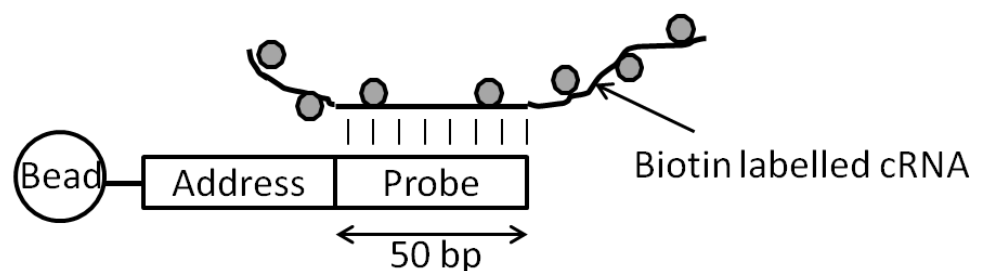
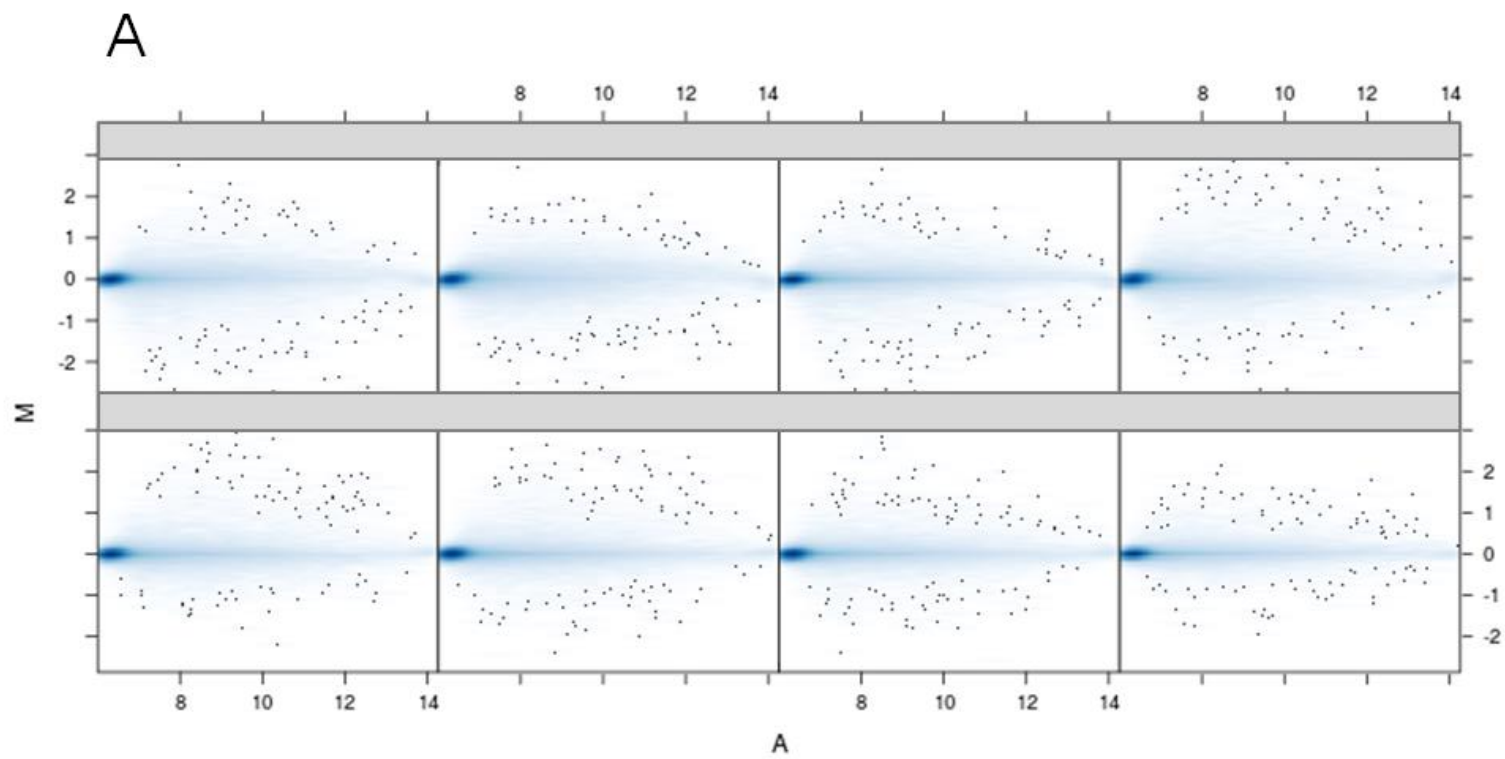
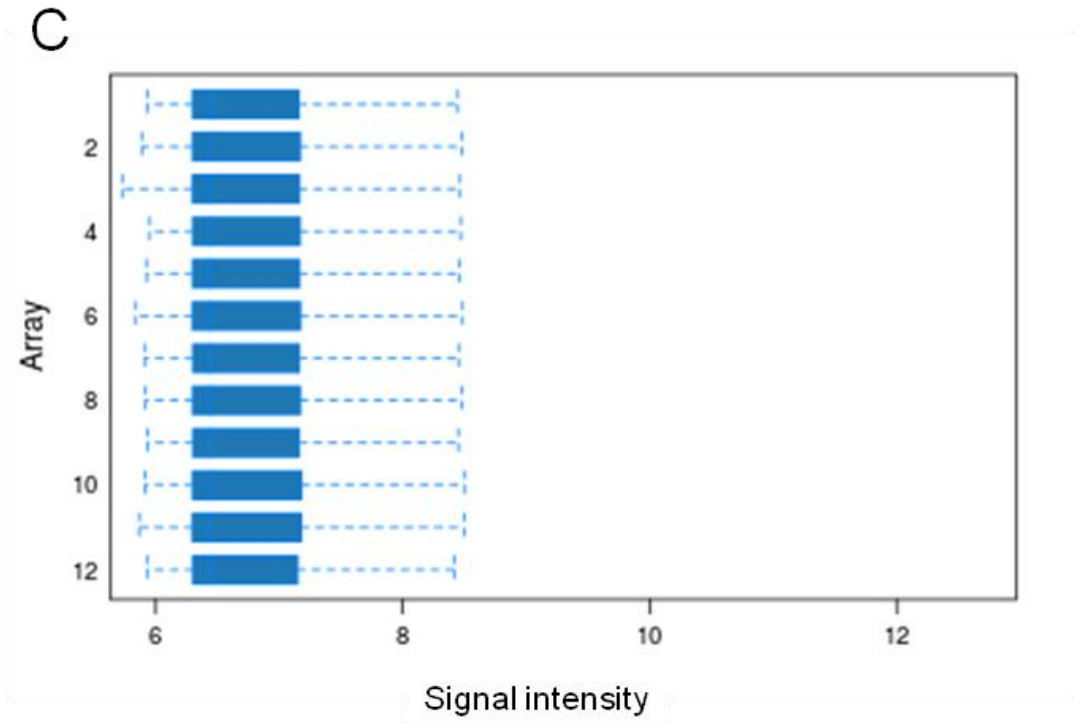
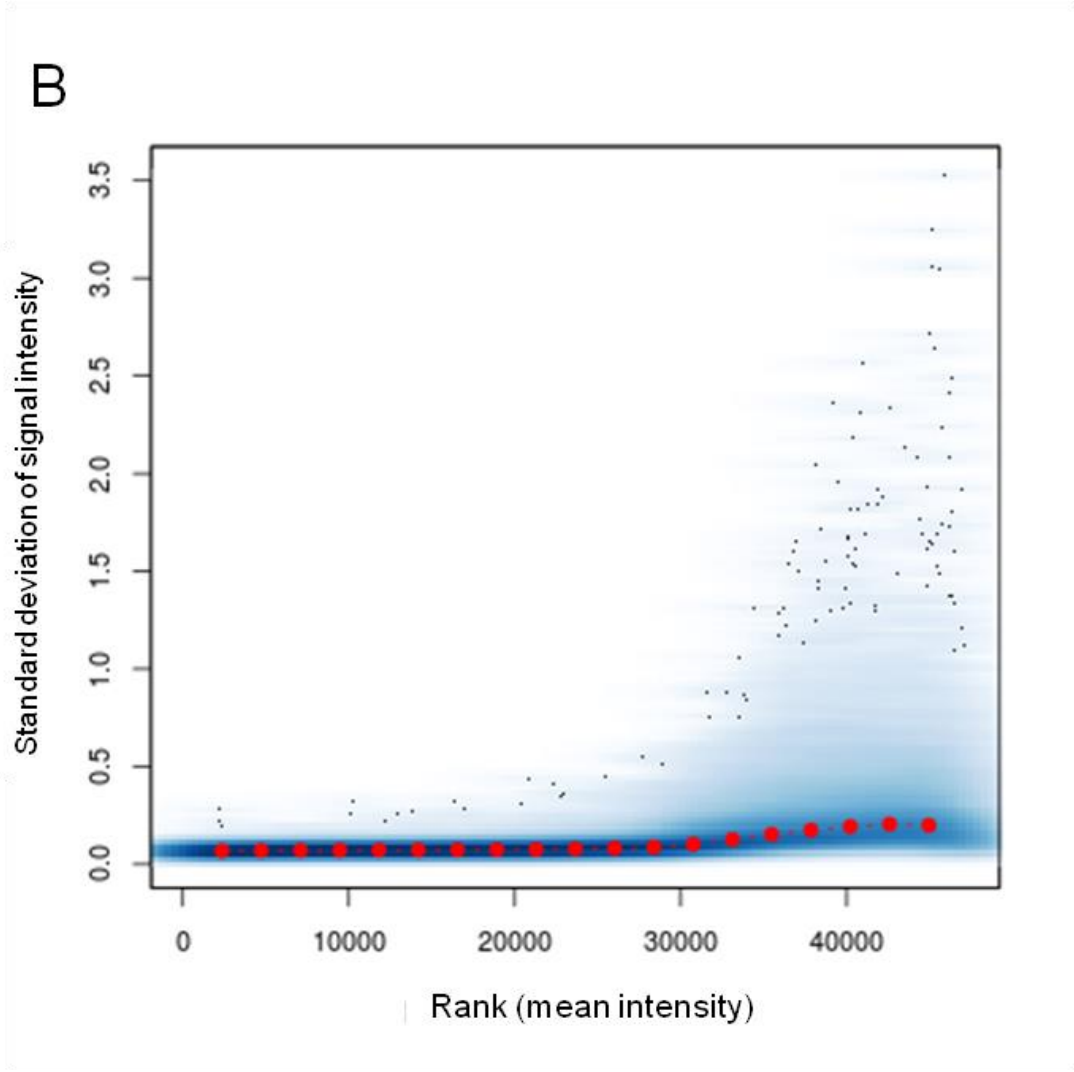

Figure E.1: The direct hybridisation assay

[A] Flow diagram showing the workflow used to perform the direct hybridisation assay. This work was performed by CGS. [B] Schematic representation of the direct hybridisation assay technology. A 50 base gene-specific probe is linked to an address sequence and the bead. The probe hybridizes to the biotin-labeled cRNA generated from test samples. Figures [A] and [B] were adapted from Illumina Inc. (2014).





D (i)

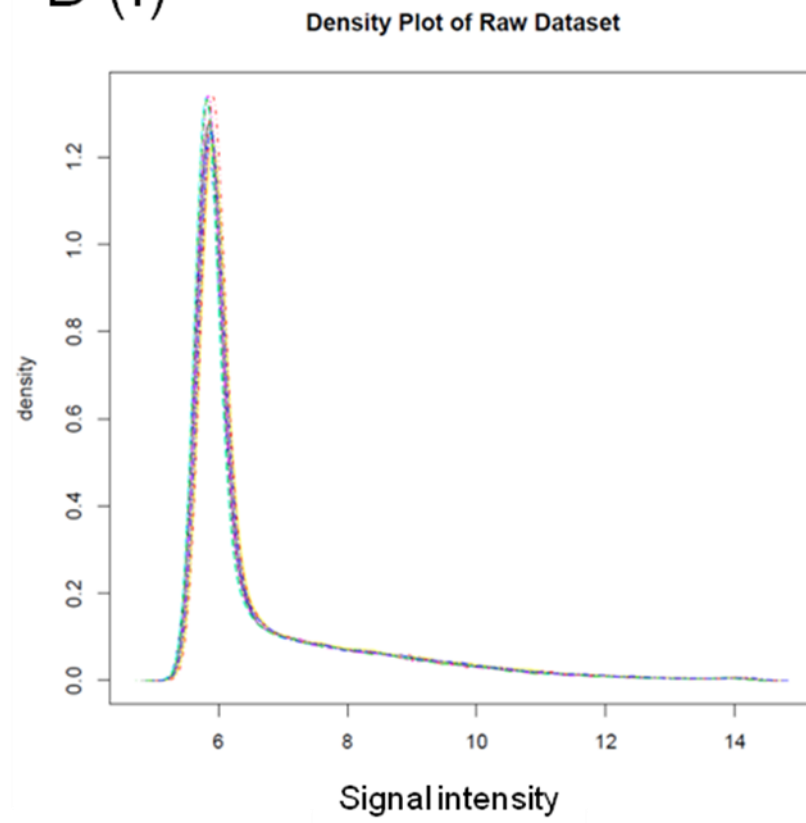

(ii)

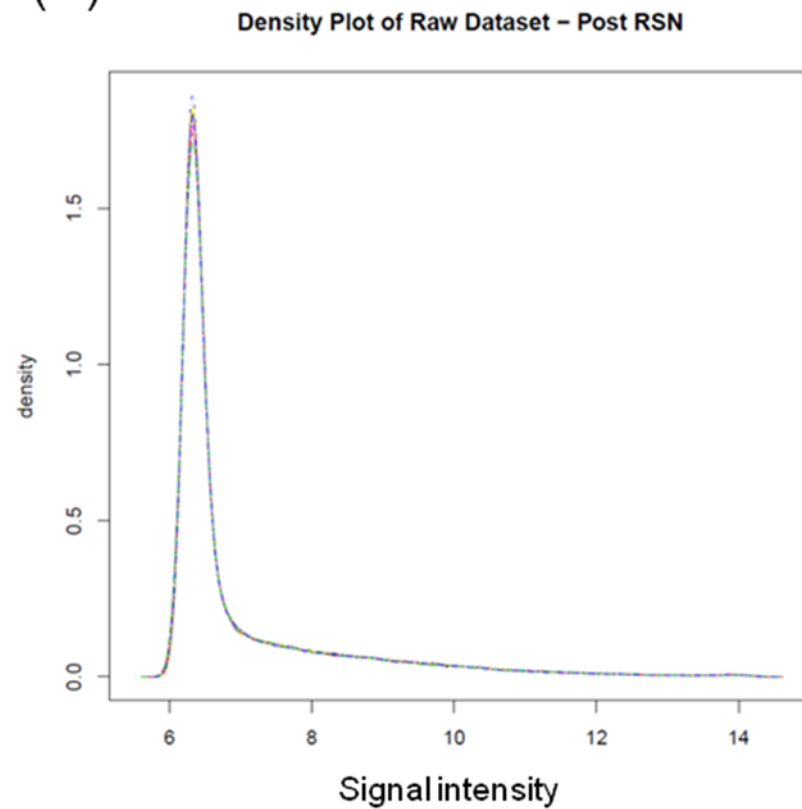

E (i)

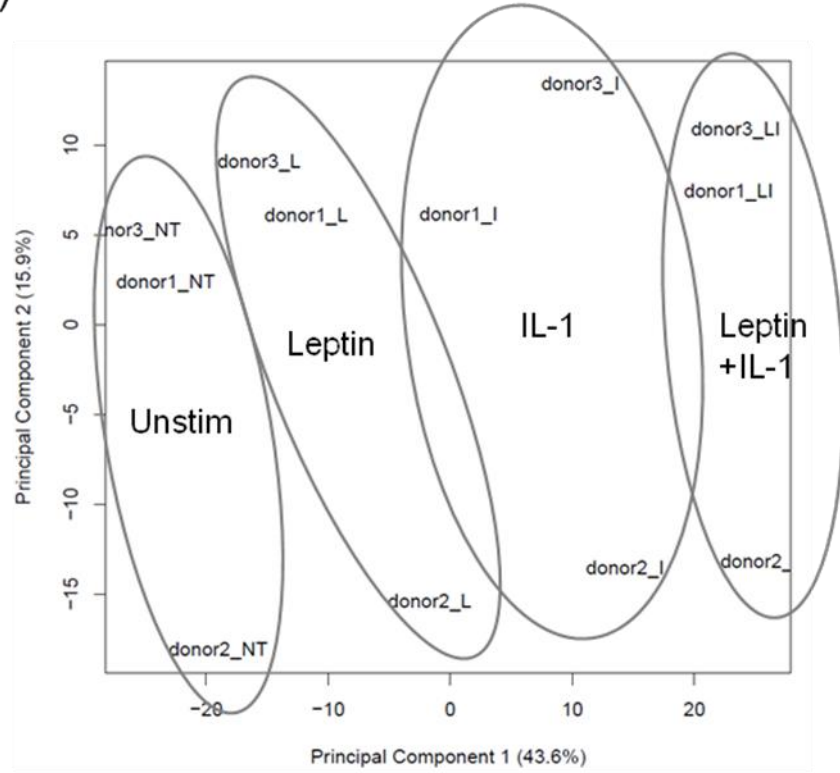

(ii)

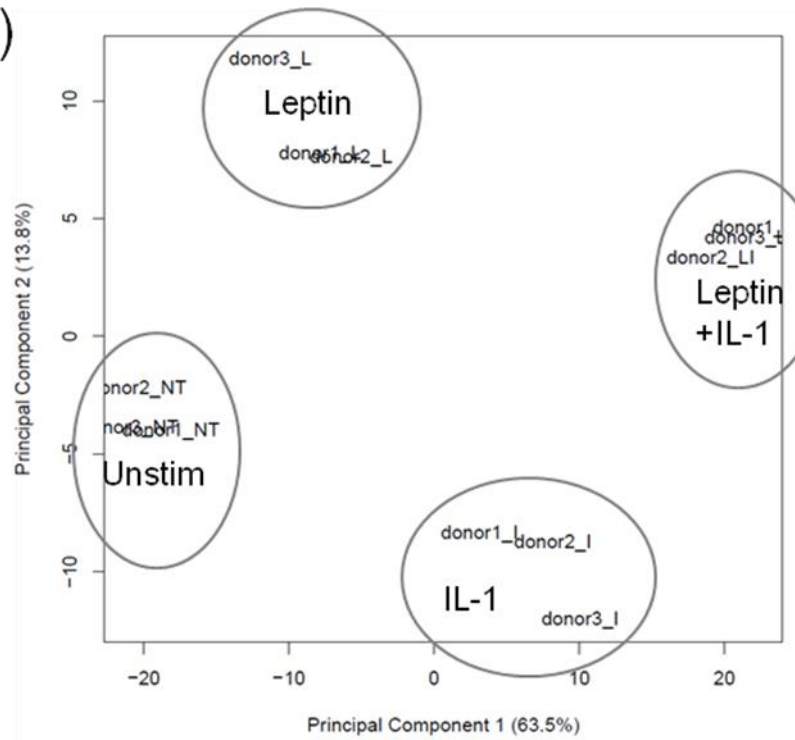
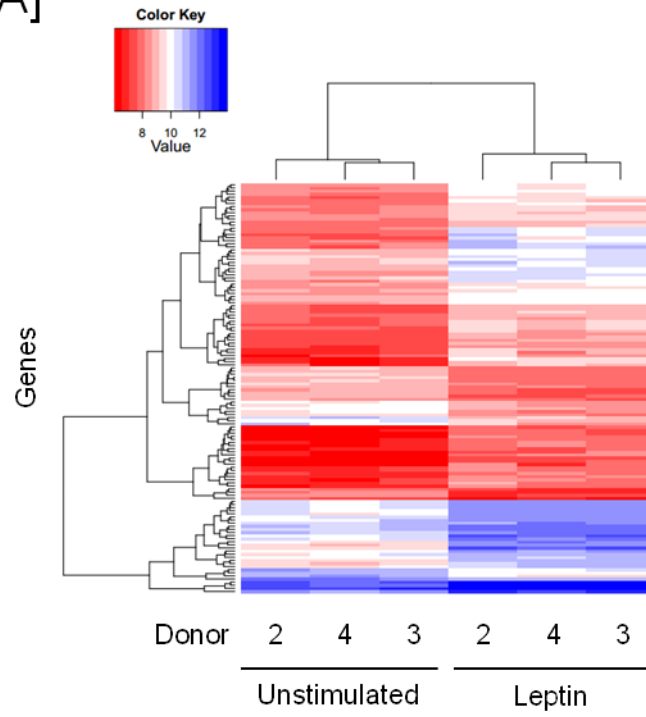

Figure E.2: QC data for the HT-12 genome-wide microarrays.

Illumina beadchip microarray technology was used to assess genome-wide expression profiles of leptin and IL-1 stimulated hGFs according to the methods described in Section 2.8.2. [A] Density plots of 8 of the microarray datasets. A calculated distribution of signal intensities for each bead (M) is plotted against the average signal intensity for each bead (A). Each plot represents one dataset (e.g. 1 treatment condition). Only 8 of 12 representative plots are shown. The majority of the data points on these graphs have a value for M near 0, which indicates that the variation in signal intensities between different beads and datasets is low. [B] A density plot showing a calculated form of the standard deviation of signal intensities across all the arrays against the ranked mean signal intensities post-normalisation. The red line represents the median SD; the horizontal nature of this line indicates that normalization was successful. [C] Box and whisker plots displaying the distribution of signal intensities for each array post-normalisation. The boxes for each array are well aligned, which supports the good quality of this experiment and the use of an appropriate normalisation technique. [D] A histogram showing the distribution of signal intensities for all arrays pre (i) and post (ii) normalisation. Each array is very well aligned which supports the good quality of this experiment. Alignment is even better after normalisation supporting the use of this normalisation technique. [E] 2-dimension principal component analysis (PCA) plots before (i) and after (ii) dataset correction. These plots are based on 29136 probes which had $SD/mean > 0.1$. In (i) arrays group by treatment, not donor, across principal component dimension 1 (x-axis). However, arrays group by donor across principal component dimension 2 (y-axis). After the dataset was corrected (ii) the arrays grouped by treatment for both dimensions of the PCA.

[A]



[B]

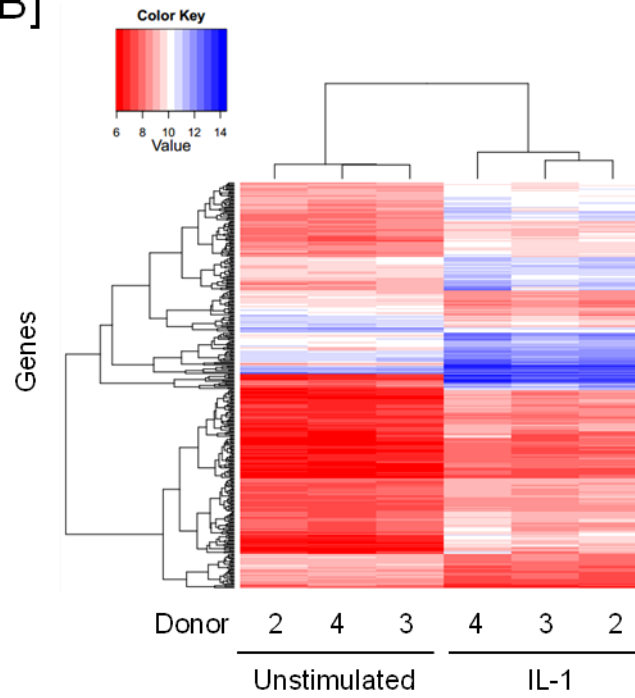

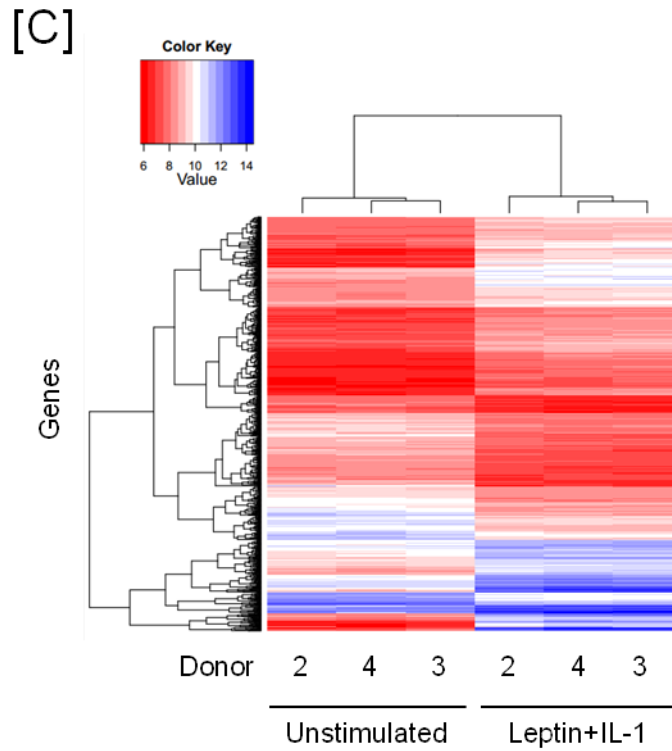

Figure E.3: Genome-wide expression profiles of hGFs after stimulation with leptin and IL-1 β .

Illumina beadchip microarray technology was used to assess genome-wide expression profiles of leptin and IL-1 stimulated hGFs according to the methods described in Section 2.8.2. Differentially expressed gene lists were generated for the comparisons unstimulated v leptin [A], unstimulated v IL-1 [B], and unstimulated v leptin+IL-1 [C]. Both the genes and samples are shown on this heat map in relation to all other genes and samples respectively by means of hierarchical clustering analysis. The relative expression levels (log₂ scale) of each gene are displayed using a colour key (red indicates lower levels of gene expression; blue indicates higher levels of gene expression).

F. Appendix F. hGF proliferation after stimulation with leptin and inflammatory mediators

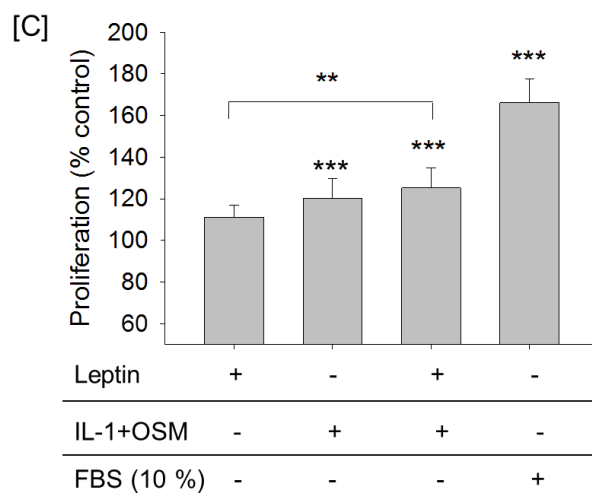
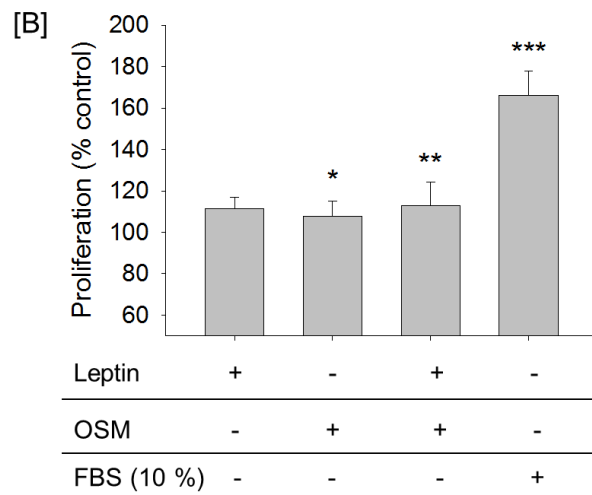
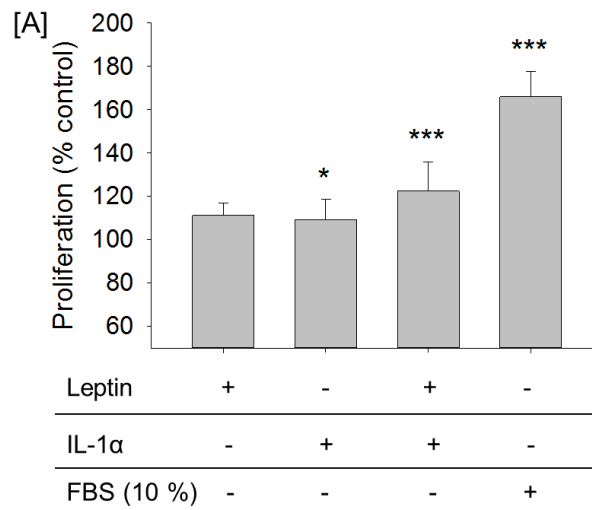

Figure F.1: hGF proliferation after stimulation with leptin, IL-1 α and OSM

hGFs were stimulated with [A] leptin (10 $\mu\text{g/ml}$), IL-1 (0.05 ng/ml) or leptin+IL-1 (leptin 10 $\mu\text{g/ml}$, IL-1 0.05 ng/ml), [B] leptin (10 $\mu\text{g/ml}$), OSM (5 ng/ml) or leptin+OSM (leptin 10 $\mu\text{g/ml}$, OSM 5 ng/ml), [C] leptin 10 $\mu\text{g/ml}$, IL-1+OSM (IL-1 0.05 ng/ml , OSM 5 ng/ml) or leptin+IL-1+OSM (leptin 10 $\mu\text{g/ml}$, IL-1 0.05 ng/ml , OSM 5 ng/ml) for 24 h. hGFs cultured in 10 % FBS-containing medium were used as a positive control. Proliferation was assessed using a tetrazolium compound-based assay. Data (mean+SD, n=9) are shown relative to the unstimulated control (% control) from three donors stimulated in independent experiments. Statistics: T tests for independent samples (Bonferroni-corrected): *=p<0.05, **=p<0.01, ***=p<0.001 compared to unstimulated control. Only selected comparison are shown for clarity.

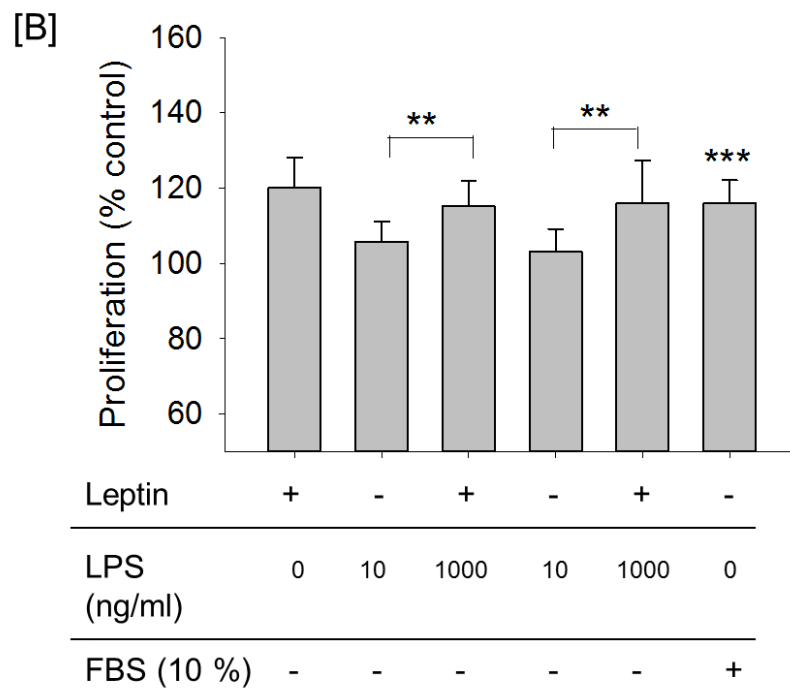
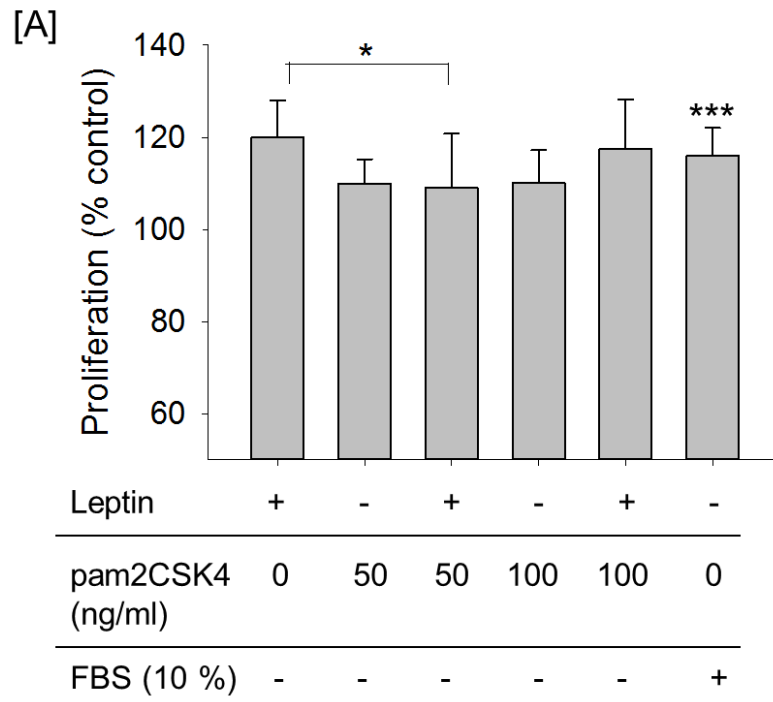

Figure F.2: hGF proliferation after stimulation with leptin, pam2CSK4 and *E. coli* LPS

hGFs were stimulated with [A] leptin (10 µg/ml), pam2CSK4 (50 or 100 ng/ml) or leptin+pam2CSK4 (leptin 10 µg/ml, pam2CSK4 50 or 100 ng/ml), [B] leptin (10 µg/ml), *E.coli* LPS (10 or 1000 ng/ml) or leptin+*E. coli* LPS (leptin 10 µg/ml, LPS 10 or 1000 ng/ml) for 24 h. hGFs cultured in 10 % FBS-containing medium were used as a positive control. Proliferation was assessed using a tetrazolium compound-based assay. Data (mean+SD, n=9-12) are shown relative to the unstimulated control (% control) from three donors stimulated in independent experiments. Statistics: T tests for independent samples (Bonferroni-corrected): *=p<0.05, **=p<0.01, ***=p<0.001 compared to unstimulated control. Only selected comparison are shown for clarity.

G. Appendix G. Time course of STAT3 and ERK phosphorylation in hGFs after stimulation with leptin.

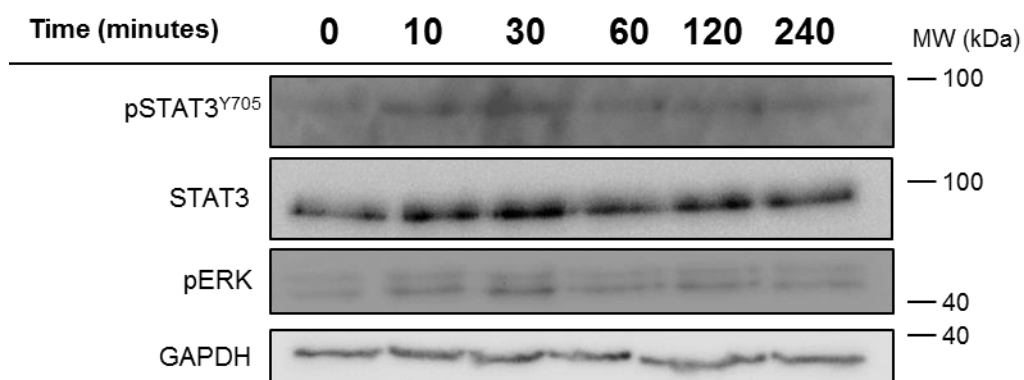

Figure G.1: Phosphorylation status of STAT3 and ERK in hGFs after stimulation with leptin.

hGFs were stimulated with leptin (10 $\mu\text{g}/\text{ml}$) for 0, 10, 30, 60, 120 and 240 min. Cells were lysed and prepared for SDS-PAGE. Extracts were immunoblotted with antibodies against phospho-pSTAT3 (Y705), STAT3, phospho-ERK (p42/44) (T202/Y204) and GAPDH as a loading control.

H. Appendix H. MMP-1 gene expression in hGFs in the presence of DMSO.

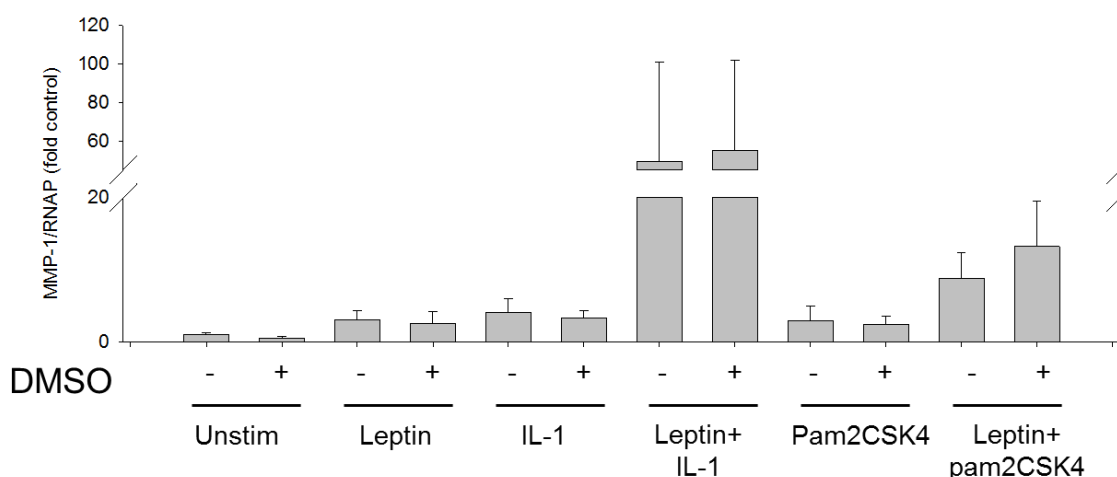
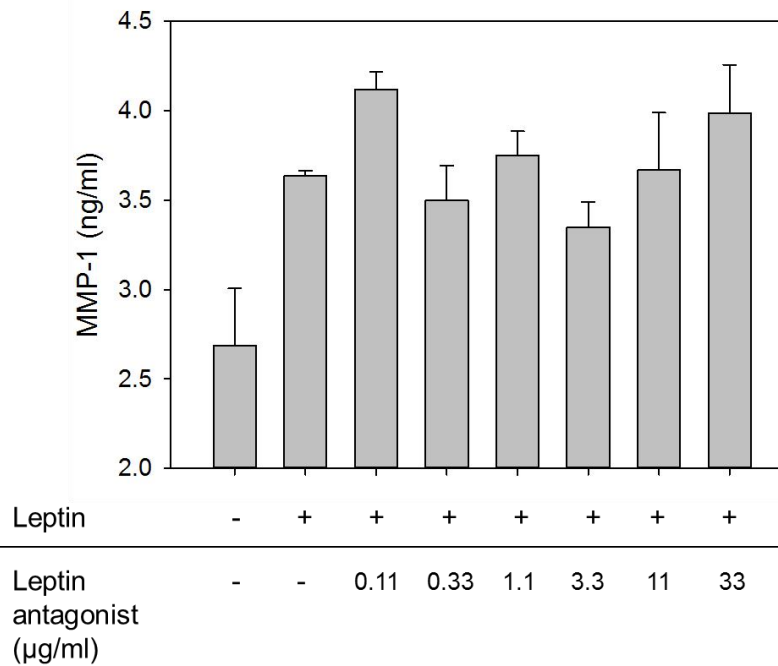

Figure H.1: DMSO does not affect MMP-1 gene expression in stimulated hGFs.

hGFs were either pre-treated with 0.1 % v/v DMSO or SFM for 30 min and then stimulated with leptin (10 $\mu\text{g/ml}$), IL-1 α (0.05 ng/ml), leptin+IL-1 α (leptin 10 $\mu\text{g/ml}$, IL-1 α 0.05 ng/ml), pam2CSK4 (50 ng/ml) or leptin+pam2CSK4 (leptin 10 $\mu\text{g/ml}$, pam2CSK4 50 ng/ml) for 24 h. Cells were lysed and cDNA was prepared by reverse transcription. Real-time RT-PCR was used to assess MMP-1 and RNAP gene expression. Relative MMP-1 mRNA expression was determined using the 2-ddCt method by using RNAP as the reference gene. Data (fold unstimulated, no DMSO control) are shown as mean+SD (n=12) from three donors stimulated in independent experiments. Statistics: T tests for independent samples (Bonferroni-corrected).

I. Appendix I. Stimulation of hGFs with leptin and a leptin antagonist

[A]



[B]

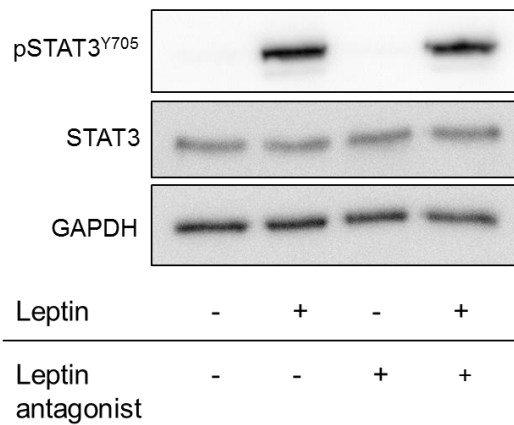

Figure I.1: MMP-1 production and STAT3 tyrosine phosphorylation in hGFs after stimulation with leptin and a leptin antagonist.

hGFs were stimulated with leptin (10 μg/ml) and/or a leptin antagonist (10 μg/ml unless indicated otherwise). [A] After 24 h supernatants were collected and assessed for MMP-1 concentration by ELISA. Data are presented as mean+SD (ng/ml, n=2, one donor). [B] After 20 min lysates were prepared from hGFs and STAT3, pSTAT3^{Y705} and GAPDH were resolved by SDS-PAGE and immunoblotting. GAPDH was used as a loading control.

J. Appendix J. Preliminary experiments for microarray analysis of gene expression in hGFs

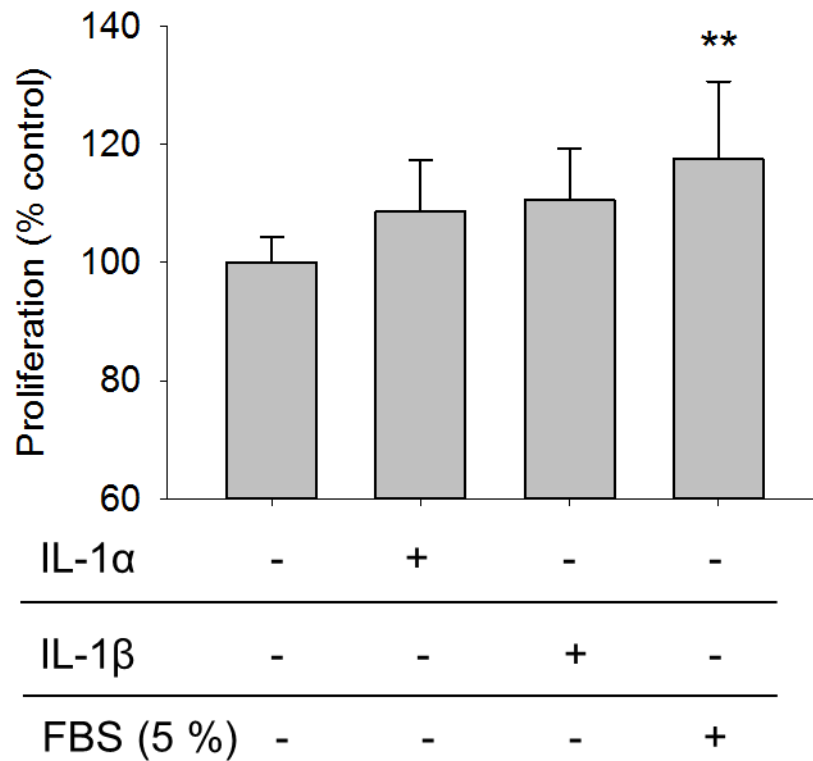

Figure J.1: hGF proliferation after stimulation with IL-1 α or IL-1 β

hGFs were stimulated with IL-1 α (0.05 ng/ml) or IL-1 β (0.05 ng/ml) for 24 h. hGFs cultured in 5 % FBS-containing DMEM were used as a positive control. Proliferation was assessed using a tetrazolium compound-based assay. Data (mean+SD, n=19-20) are shown relative to the unstimulated control (% control) from two donors stimulated in independent experiments. Statistics: T tests or Mann-Whitney U test for independent samples as required (Bonferroni-corrected): **=p<0.01 compared to unstimulated control.

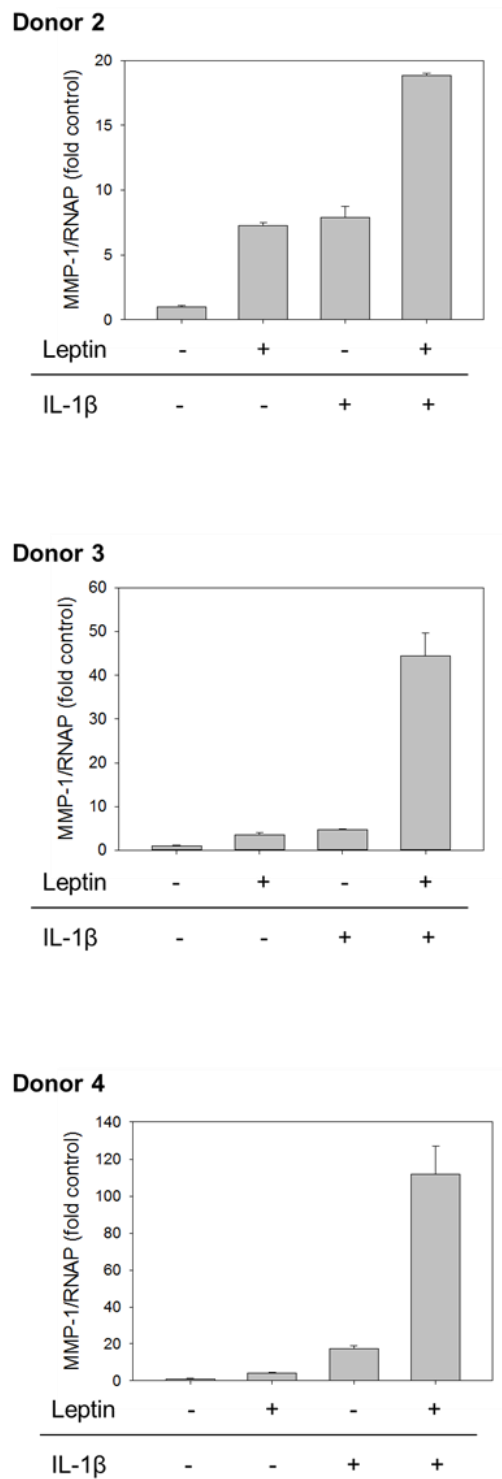

Figure J.2: MMP-1 gene expression in hGFs after stimulation with leptin and IL-1 β .

hGFs from three donors were stimulated with leptin (10 μ g/ml), IL-1 β (0.05 ng/ml) or leptin+IL-1 β (leptin 10 μ g/ml, IL-1 β 0.05 ng/ml) for 24 h in independent experiments (6-well format). Cells were lysed, RNA extracted and cDNA was prepared by reverse transcription. Real-time RT-PCR was used to assess MMP-1 and RNAP gene expression. Relative MMP-1 gene expression was determined using the 2^{-ddCt} method by using RNAP as the reference gene. Data (fold unstimulated control) on each graph are shown as mean+SD (n=2) from one donor as indicated.

Table J.1: hGF RNA concentration and quality assessment for the genome-wide expression microarray

hGFs from three donors (donors 2-4 as indicated) were stimulated with leptin (10 µg/ml), IL-1β (0.05 ng/ml) or leptin+IL-1β (leptin 10 µg/ml, IL-1β 0.05 ng/ml) for 24 h in independent experiments (6-well format). Cells were lysed and RNA extracted. RNA yield (concentration - ng/µl) and quality (260/280 and 260/230 ratios) were assessed using a NanoDrop spectrophotometer. Treatment groups: NT – unstimulated control, L – leptin, I – IL-1β, LI – leptin+IL-1β.

Donor	Treatment group	Concentration (ng/µl)	260/280 ratio	260/230 ratio
2	NT	189	2.1	2.0
	L	200	2.1	2.0
	I	193	2.1	2.1
	LI	204	2.1	2.1
3	NT	139	2.1	2.0
	L	136	2.1	1.6
	I	131	2.1	1.6
	LI	143	2.0	2.0
4	NT	125	2.1	2.1
	L	139	2.1	2.0
	I	137	2.1	1.8
	LI	134	2.1	2.1

K. Appendix K. ELISA standard curves

A

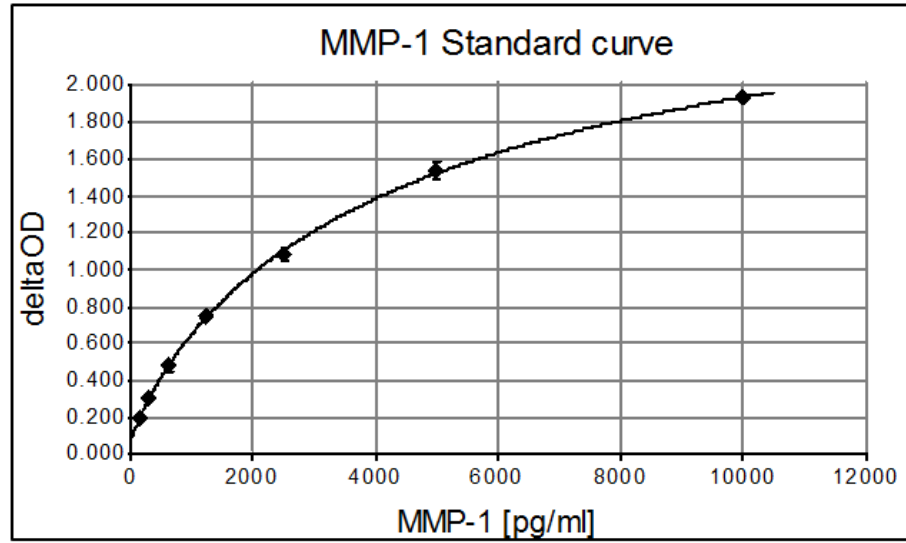

B

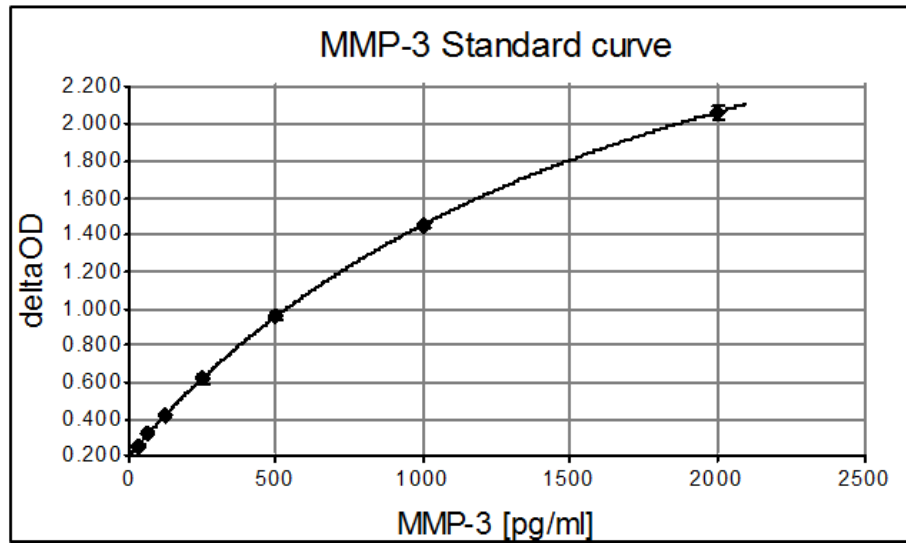

C

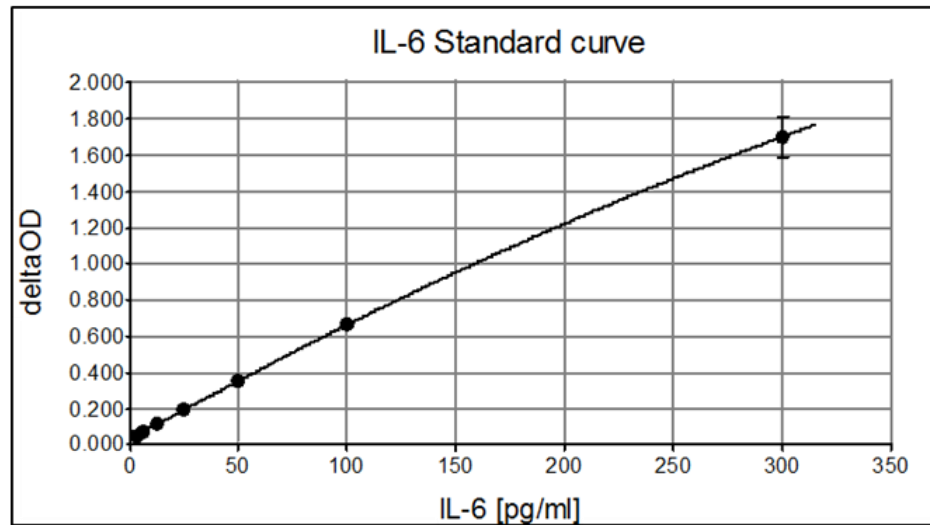

D

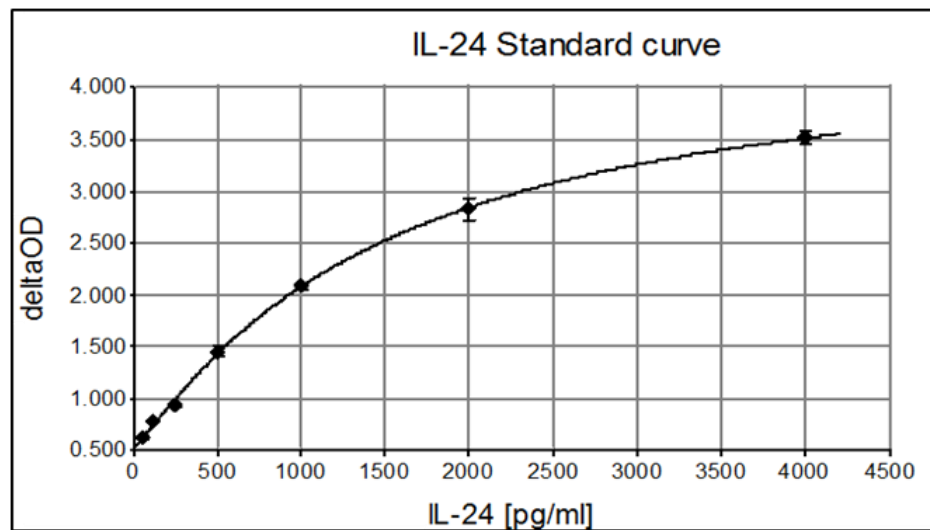

Figure K.1: Representative standard curves for the ELISAs used in this study.

Mean \pm SD absorbance (450 nm -550 nm/deltaOD) was plotted against standard concentrations (0 – 10000 pg/ml for MMP-1 [A], 0 – 2000 pg/ml for MMP-3 [B], 0 – 300 pg/ml IL-6 [C], 0 – 4000 pg/ml IL-24 [D]). A 4PL curve was fitted and used to determine the unknown concentration of these proteins in samples.

L. List of presentations and manuscripts

Manuscripts in preparation:

Williams, R.C., Rowan, A.D., Preshaw, P.M. and Taylor, J.J. 'The role of gingival fibroblasts in inflammation'.

Williams, R.C., Todryk, S., Rowan, A.D., Preshaw, P.M. and Taylor, J.J. 'Leptin synergises with IL-1, LPS and the TLR-2 agonist pam2CSK4 to enhance MMP production in human gingival fibroblasts via the MAPK and JAK-STAT pathways'

Presentations:

- Jun. 2014:** International Association for Dental Research General Session, Cape Town, South Africa (Poster presentations)
Leptin-mediated MMP-1 production in gingival fibroblasts requires MAPK signalling
The regulation of gingival fibroblast MMPs by pro-inflammatory ligands
- May 2014:** Gordon Research Seminar and Conference in Immunochemistry and Immunobiology, Maine, USA (Poster presentation)
Interleukin-1 and leptin require ERK signalling to synergistically increase MMP-1 production in gingival fibroblasts
- Apr. 2014:** FameLab UK Grand Final, London (Oral Presentation)
Inflammation: what, why and ow!
<https://www.youtube.com/watch?v=d76c3FCvYi0>
- Nov. 2014:** FameLab NorthEast regional heats and final, Newcastle (Oral presentations) – Regional winner
What's hiding in your mouth?!
<https://www.youtube.com/watch?v=vOn6TXXnF0>
Collagen <https://www.youtube.com/watch?v=Kq9tOy28vhk>
- Sep. 2014:** British Science Festival, Newcastle (Interactive workshop)
What's hiding in your mouth?!
- Sep. 2014:** British Society for Oral and Dental Research Annual meeting, Bath (Oral presentation) - Senior Colgate Prize runner up
Leptin synergistically enhances a matrix-degrading gingival fibroblast phenotype
- Jul. 2013:** British Society for Immunology Summer School, Newcastle (Poster presentation)
Leptin synergistically elevates matrix metalloproteinase-1 and -3 production by human gingival fibroblasts

Jan. 2013: British Society for Oral and Dental Research Oral Microbiology and Immunology Group postgraduate meeting, UCL (Oral presentation) – first prize

Leptin synergistically upregulates matrix metalloproteinase-1 in human gingival fibroblasts

Dec. 2012: European Congress of Immunology, Glasgow (Poster presentation)

Interleukin-1 and leptin synergistically enhance matrix metalloproteinase expression in human gingival fibroblasts

Apr. 2012: British Society for Matrix Biology Annual Meeting, Oxford (Poster presentation)

Leptin regulation of matrix metalloproteinase expression in human gingival fibroblasts

9 References

- Abe, M., Kawamoto, K., Okamoto, H. and Horiuchi, N. (2001) 'Induction of collagenase-2 (matrix metalloproteinase-8) gene expression by interleukin-1beta in human gingival fibroblasts', *J Periodontal Res*, 36(3), pp. 153-9.
- Abiko, Y., Hiratsuka, K., Kiyama-Kishikawa, M., Tsushima, K., Ohta, M. and Sasahara, H. (2004) 'Profiling of differentially expressed genes in human gingival epithelial cells and fibroblasts by DNA microarray', *J Oral Sci*, 46(1), pp. 19-24.
- Achong, R., Nishimura, I., Ramachandran, H., Howell, T.H., Fiorellini, J.P. and Karimbux, N.Y. (2003) 'Membrane type (MT) 1-matrix metalloproteinase (MMP) and MMP-2 expression in ligature-induced periodontitis in the rat', *J Periodontol*, 74(4), pp. 494-500.
- Ahmed, S.T. and Ivashkiv, L.B. (2000) 'Inhibition of IL-6 and IL-10 signaling and Stat activation by inflammatory and stress pathways', *J Immunol*, 165(9), pp. 5227-37.
- Akalin, F.A., Sengun, D., Eratalay, K., Renda, N. and Caglayan, G. (1993) 'Hydroxyproline and total protein levels in gingiva and gingival crevicular fluid in patients with juvenile, rapidly progressive, and adult periodontitis', *J Periodontol*, 64(5), pp. 323-9.
- Al-Hassi, H.O., Bernardo, D., Muruganathan, A.U., Mann, E.R., English, N.R., Jones, A., Kamm, M.A., Arebi, N., Hart, A.L., Blakemore, A.I.F., Stagg, A.J. and Knight, S.C. (2013) 'A mechanistic role for leptin in human dendritic cell migration: differences between ileum and colon in health and Crohn's disease', *Mucosal Immunol*, 6(4), pp. 751-761.
- Alberti, K.G., Zimmet, P. and Shaw, J. (2006) 'Metabolic syndrome--a new world-wide definition. A Consensus Statement from the International Diabetes Federation', *Diabet Med*, 23(5), pp. 469-80.
- Aleffi, S., Petrai, I., Bertolani, C., Parola, M., Colombatto, S., Novo, E., Vizzutti, F., Anania, F.A., Milani, S., Rombouts, K., Laffi, G., Pinzani, M. and Marra, F. (2005) 'Upregulation of proinflammatory and proangiogenic cytokines by leptin in human hepatic stellate cells', *Hepatology*, 42(6), pp. 1339-48.
- Altay, U., Gurgan, C.A. and Agbaht, K. (2013) 'Changes in inflammatory and metabolic parameters after periodontal treatment in patients with and without obesity', *J Periodontol*, 84(1), pp. 13-23.
- Andoh, A., Shioya, M., Nishida, A., Bamba, S., Tsujikawa, T., Kim-Mitsuyama, S. and Fujiyama, Y. (2009) 'Expression of IL-24, an activator of the JAK1/STAT3/SOCS3 cascade, is enhanced in inflammatory bowel disease', *J Immunol*, 183(1), pp. 687-95.
- Andrian, E., Grenier, D. and Rouabhia, M. (2004) 'In vitro models of tissue penetration and destruction by Porphyromonas gingivalis', *Infect Immun*, 72(8), pp. 4689-98.
- Andrian, E., Mostefaoui, Y., Rouabhia, M. and Grenier, D. (2007) 'Regulation of matrix metalloproteinases and tissue inhibitors of matrix metalloproteinases by Porphyromonas gingivalis in an engineered human oral mucosa model', *J Cell Physiol*, 211(1), pp. 56-62.
- Ara, T., Kurata, K., Hirai, K., Uchihashi, T., Uematsu, T., Imamura, Y., Furusawa, K., Kurihara, S. and Wang, P.L. (2009) 'Human gingival fibroblasts are critical in sustaining inflammation in periodontal disease', *J Periodontal Res*, 44(1), pp. 21-7.
- Arancibia, R., Oyarzun, A., Silva, D., Tobar, N., Martinez, J. and Smith, P.C. (2012) 'Tnf-alpha Inhibits Tgf-beta-Stimulated Myofibroblastic Differentiation and Extracellular Matrix Production in Human Gingival Fibroblasts', *J Periodontol*.
- Armbruster, D.A., Tillman, M.D. and Hubbs, L.M. (1994) 'Limit of detection (LQD)/limit of quantitation (LOQ): comparison of the empirical and the statistical methods exemplified with GC-MS assays of abused drugs', *Clin Chem*, 40(7 Pt 1), pp. 1233-8.
- Arris, C.E., Bevitt, D.J., Mohamed, J., Li, Z., Langton, K.P., Barker, M.D., Clarke, M.P. and McKie, N. (2003) 'Expression of mutant and wild-type TIMP3 in primary gingival fibroblasts from Sorsby's fundus dystrophy patients', *Biochimica et Biophysica Acta (BBA) - Molecular Basis of Disease*, 1638(1), pp. 20-28.
- Aubin, J.E., Osborn, M., Franke, W.W. and Weber, K. (1980) 'Intermediate filaments of the vimentin-type and the cytokeratin-type are distributed differently during mitosis', *Experimental Cell Research*, 129(1), pp. 149-165.
- Ay, Z.Y., Kirzioglu, F.Y., Tonguc, M.O., Sutcu, R. and Kapucuoglu, N. (2012) 'The gingiva contains leptin and leptin receptor in health and disease', *Odontology*, 100(2), pp. 222-31.

- Båge, T., Kats, A., Lopez, B.S., Morgan, G., Nilsson, G., Burt, I., Korotkova, M., Corbett, L., Knox, A.J., Pino, L., Jakobsson, P.-J., Modéer, T. and Yucel-Lindberg, T. (2011) 'Expression of Prostaglandin E Synthases in Periodontitis: Immunolocalization and Cellular Regulation', *The American Journal of Pathology*, 178(4), pp. 1676-1688.
- Bage, T., Lindberg, J., Lundeberg, J., Modeer, T. and Yucel-Lindberg, T. (2010) 'Signal pathways JNK and NF-kappaB, identified by global gene expression profiling, are involved in regulation of TNFalpha-induced mPGES-1 and COX-2 expression in gingival fibroblasts', *BMC Genomics*, 11(1), p. 241.
- Barchowsky, A., Frleta, D. and Vincenti, M.P. (2000) 'Integration of the NF-kappaB and mitogen-activated protein kinase/AP-1 pathways at the collagenase-1 promoter: divergence of IL-1 and TNF-dependent signal transduction in rabbit primary synovial fibroblasts', *Cytokine*, 12(10), pp. 1469-79.
- Barkan, D., Hurgin, V., Dekel, N., Amsterdam, A. and Rubinstein, M. (2005) 'Leptin induces ovulation in GnRH-deficient mice', *FASEB J*, 19(1), pp. 133-5.
- Barksby, H.E., Milner, J.M., Patterson, A.M., Peake, N.J., Hui, W., Robson, T., Lakey, R., Middleton, J., Cawston, T.E., Richards, C.D. and Rowan, A.D. (2006) 'Matrix metalloproteinase 10 promotion of collagenolysis via procollagenase activation: implications for cartilage degradation in arthritis', *Arthritis Rheum*, 54(10), pp. 3244-53.
- Barksby, H.E., Nile, C.J., Jaedicke, K.M., Taylor, J.J. and Preshaw, P.M. (2009) 'Differential expression of immunoregulatory genes in monocytes in response to Porphyromonas gingivalis and Escherichia coli lipopolysaccharide', *Clin Exp Immunol*, 156(3), pp. 479-87.
- Barnes, M., Freudenberg, J., Thompson, S., Aronow, B. and Pavlidis, P. (2005) 'Experimental comparison and cross-validation of the Affymetrix and Illumina gene expression analysis platforms', *Nucleic Acids Res*, 33(18), pp. 5914-23.
- Bartold, P.M. and Narayanan, A.S. (2006) 'Molecular and cell biology of healthy and diseased periodontal tissues', *Periodontol 2000*, 40, pp. 29-49.
- Bartold, P.M., Narayanan, A.S. and Page, R.C. (1992) 'Platelet-derived growth factor reduces the inhibitory effects of lipopolysaccharide on gingival fibroblast proliferation', *Journal of Periodontal Research*, 27(5), pp. 499-505.
- Basso, K. and Dalla-Favera, R. (2012) 'Roles of BCL6 in normal and transformed germinal center B cells', *Immunol Rev*, 247(1), pp. 172-83.
- Becerik, S., Ozturk, V.O., Atmaca, H., Atilla, G. and Emingil, G. (2012) 'Gingival crevicular fluid and plasma acute-phase cytokine levels in different periodontal diseases', *J Periodontol*, 83(10), pp. 1304-13.
- Beertsen, W., McCulloch, C.A.G. and Sodek, J. (1997) 'The periodontal ligament: a unique, multifunctional connective tissue', *Periodontology 2000*, 13(1), pp. 20-40.
- Beklen, A., Hukkanen, M., Richardson, R. and Konttinen, Y.T. (2008) 'Immunohistochemical localization of Toll-like receptors 1-10 in periodontitis', *Oral Microbiol Immunol*, 23(5), pp. 425-31.
- Beklen, A., Tuter, G., Sorsa, T., Hanemaaijer, R., Virtanen, I., Tervahartiala, T. and Konttinen, Y.T. (2006) 'Gingival tissue and crevicular fluid co-operation in adult periodontitis', *J Dent Res*, 85(1), pp. 59-63.
- Belibasakis, G.N. and Guggenheim, B. (2011) 'Induction of prostaglandin E2 and interleukin-6 in gingival fibroblasts by oral biofilms', *FEMS Immunology & Medical Microbiology*, 63(3), pp. 381-386.
- Belibasakis, G.N., Guggenheim, B. and Bostanci, N. (2013) 'Down-regulation of NLRP3 inflammasome in gingival fibroblasts by subgingival biofilms: Involvement of Porphyromonas gingivalis', *Innate Immunity*, 19(1), pp. 3-9.
- Bendyk, A., Marino, V., Zilm, P.S., Howe, P. and Bartold, P.M. (2009) 'Effect of dietary omega-3 polyunsaturated fatty acids on experimental periodontitis in the mouse', *J Periodontal Res*, 44(2), pp. 211-6.
- Beningo, K.A., Dembo, M. and Wang, Y.L. (2004) 'Responses of fibroblasts to anchorage of dorsal extracellular matrix receptors', *Proc Natl Acad Sci U S A*, 101(52), pp. 18024-9.
- Bennett, B.L., Sasaki, D.T., Murray, B.W., O'Leary, E.C., Sakata, S.T., Xu, W., Leisten, J.C., Motiwala, A., Pierce, S., Satoh, Y., Bhagwat, S.S., Manning, A.M. and Anderson, D.W. (2001) 'SP600125, an anthrapyrazolone inhibitor of Jun N-terminal kinase', *Proc Natl Acad Sci U S A*, 98(24), pp. 13681-6.

- Bergman, I. and Loxley, R. (1963) 'Two Improved and Simplified Methods for the Spectrophotometric Determination of Hydroxyproline', *Analytical Chemistry*, 35(12), pp. 1961-1965.
- Bezbradica, J.S. and Medzhitov, R. (2009) 'Integration of cytokine and heterologous receptor signaling pathways', *Nat Immunol*, 10(4), pp. 333-9.
- Bhide, V.M., Laschinger, C.A., Arora, P.D., Lee, W., Hakkinen, L., Larjava, H., Sodek, J. and McCulloch, C.A. (2005) 'Collagen Phagocytosis by Fibroblasts Is Regulated by Decorin', *Journal of Biological Chemistry*, 280(24), pp. 23103-23113.
- Birkedal-Hansen, H. (1993) 'Role of matrix metalloproteinases in human periodontal diseases', *J Periodontol*, 64(5 Suppl), pp. 474-84.
- Bjorbaek, C., Uotani, S., da Silva, B. and Flier, J.S. (1997) 'Divergent signaling capacities of the long and short isoforms of the leptin receptor', *J Biol Chem*, 272(51), pp. 32686-95.
- Bjornsson, M.J., Havemose-Poulsen, A., Stoltze, K. and Holmstrup, P. (2004) 'Influence of the matrix metalloproteinase inhibitor batimastat (BB-94) on periodontal bone destruction in Sprague-Dawley rats', *J Periodontal Res*, 39(4), pp. 269-74.
- Blum, J.S., Wearsch, P.A. and Cresswell, P. (2013) 'Pathways of antigen processing', *Annu Rev Immunol*, 31, pp. 443-73.
- Bodet, C., Andrian, E., Tanabe, S.-i. and Grenier, D. (2007) 'Actinobacillus actinomycetemcomitans lipopolysaccharide regulates matrix metalloproteinase, tissue inhibitors of matrix metalloproteinase, and plasminogen activator production by human gingival fibroblasts: A potential role in connective tissue destruction', *Journal of Cellular Physiology*, 212(1), pp. 189-194.
- Bolcato-Bellemin, A.L., Elkaim, R., Abehsera, A., Fausser, J.L., Haikel, Y. and Tenenbaum, H. (2000) 'Expression of mRNAs encoding for alpha and beta integrin subunits, MMPs, and TIMPs in stretched human periodontal ligament and gingival fibroblasts', *J Dent Res*, 79(9), pp. 1712-6.
- Bonnemann, C.G. (2011) 'The collagen VI-related myopathies: muscle meets its matrix', *Nat Rev Neurol*, 7(7), pp. 379-90.
- Bostanci, N., Meier, A., Guggenheim, B. and Belibasakis, G.N. (2011) 'Regulation of NLRP3 and AIM2 inflammasome gene expression levels in gingival fibroblasts by oral biofilms', *Cellular Immunology*, 270(1), pp. 88-93.
- Botero, J.E., Contreras, A. and Parra, B. (2008) 'Profiling of inflammatory cytokines produced by gingival fibroblasts after human cytomegalovirus infection', *Oral Microbiology and Immunology*, 23(4), pp. 291-298.
- Bowie, A. and O'Neill, L.A. (2000) 'The interleukin-1 receptor/Toll-like receptor superfamily: signal generators for pro-inflammatory interleukins and microbial products', *J Leukoc Biol*, 67(4), pp. 508-14.
- Bozkurt, F.Y., Yetkin Ay, Z., Sutcu, R., Delibas, N. and Demirel, R. (2006) 'Gingival crevicular fluid leptin levels in periodontitis patients with long-term and heavy smoking', *J Periodontol*, 77(4), pp. 634-40.
- Branch-Mays, G.L., Dawson, D.R., Gunsolley, J.C., Reynolds, M.A., Ebersole, J.L., Novak, K.F., Mattison, J.A., Ingram, D.K. and Novak, M.J. (2008) 'The effects of a calorie-reduced diet on periodontal inflammation and disease in a non-human primate model', *J Periodontol*, 79(7), pp. 1184-91.
- Brocke, P., Garbi, N., Momburg, F. and Hammerling, G.J. (2002) 'HLA-DM, HLA-DO and tapasin: functional similarities and differences', *Curr Opin Immunol*, 14(1), pp. 22-9.
- Brunius, G., Domeij, H., Gustavsson, A. and Yucel-Lindberg, T. (2005) 'Bradykinin upregulates IL-8 production in human gingival fibroblasts stimulated by interleukin-1 β and tumor necrosis factor α ', *Regulatory Peptides*, 126(3), pp. 183-188.
- Bruno, A., Conus, S., Schmid, I. and Simon, H.U. (2005) 'Apoptotic pathways are inhibited by leptin receptor activation in neutrophils', *J Immunol*, 174(12), pp. 8090-6.
- Buckley, C.D. (2011) 'Why does chronic inflammation persist: An unexpected role for fibroblasts', *Immunology Letters*, 138(1), pp. 12-14.
- Buckley, C.D., Pilling, D., Lord, J.M., Akbar, A.N., Scheel-Toellner, D. and Salmon, M. (2001) 'Fibroblasts regulate the switch from acute resolving to chronic persistent inflammation', *Trends Immunol*, 22(4), pp. 199-204.

- Bullon, P., Morillo, J.M., Ramirez-Tortosa, M.C., Quiles, J.L., Newman, H.N. and Battino, M. (2009) 'Metabolic syndrome and periodontitis: is oxidative stress a common link?', *J Dent Res*, 88(6), pp. 503-18.
- Burns, E., Bachrach, G., Shapira, L. and Nussbaum, G. (2006) 'Cutting Edge: TLR2 is required for the innate response to *Porphyromonas gingivalis*: activation leads to bacterial persistence and TLR2 deficiency attenuates induced alveolar bone resorption', *J Immunol*, 177(12), pp. 8296-300.
- Burrage, P.S., Mix, K.S. and Brinckerhoff, C.E. (2006) 'Matrix metalloproteinases: role in arthritis', *Front Biosci*, 11, pp. 529-43.
- Busso, N., So, A., Chobaz-Peclat, V., Morard, C., Martinez-Soria, E., Talabot-Ayer, D. and Gabay, C. (2002) 'Leptin signaling deficiency impairs humoral and cellular immune responses and attenuates experimental arthritis', *J Immunol*, 168(2), pp. 875-82.
- Cantley, M.D., Bartold, P.M., Marino, V., Reid, R.C., Fairlie, D.P., Wyszynski, R.N., Zilm, P.S. and Haynes, D.R. (2009) 'The use of live-animal micro-computed tomography to determine the effect of a novel phospholipase A2 inhibitor on alveolar bone loss in an in vivo mouse model of periodontitis', *Journal of Periodontal Research*, 44(3), pp. 317-322.
- Cantley, M.D., Haynes, D.R., Marino, V. and Bartold, P.M. (2011) 'Pre-existing periodontitis exacerbates experimental arthritis in a mouse model', *J Clin Periodontol*, 38(6), pp. 532-41.
- Cao, Q., Mak, K.M. and Lieber, C.S. (2007) 'Leptin represses matrix metalloproteinase-1 gene expression in LX2 human hepatic stellate cells', *J Hepatol*, 46(1), pp. 124-33.
- Cao, Z., Li, C., Jin, L. and Corbet, E.F. (2005) 'Association of matrix metalloproteinase-1 promoter polymorphism with generalized aggressive periodontitis in a Chinese population', *J Periodontal Res*, 40(6), pp. 427-31.
- Carvalho, J.B., Torsoni, M.A., Ueno, M., Amaral, M.E., Araujo, E.P., Velloso, L.A., Gontijo, J.A. and Saad, M.J. (2005) 'Cross-talk between the insulin and leptin signaling systems in rat hypothalamus', *Obes Res*, 13(1), pp. 48-57.
- Catterall, J.B., Carrere, S., Koshy, P.J., Degnan, B.A., Shingleton, W.D., Brinckerhoff, C.E., Rutter, J., Cawston, T.E. and Rowan, A.D. (2001) 'Synergistic induction of matrix metalloproteinase 1 by interleukin-1alpha and oncostatin M in human chondrocytes involves signal transducer and activator of transcription and activator protein 1 transcription factors via a novel mechanism', *Arthritis Rheum*, 44(10), pp. 2296-310.
- Caudell, E.G., Mumm, J.B., Poindexter, N., Ekmekcioglu, S., Mhashilkar, A.M., Yang, X.H., Retter, M.W., Hill, P., Chada, S. and Grimm, E.A. (2002) 'The protein product of the tumor suppressor gene, melanoma differentiation-associated gene 7, exhibits immunostimulatory activity and is designated IL-24', *J Immunol*, 168(12), pp. 6041-6.
- Cawston, T.E., Curry, V.A., Summers, C.A., Clark, I.M., Riley, G.P., Life, P.F., Spaul, J.R., Goldring, M.B., Koshy, P.J.T., Rowan, A.D. and Shingleton, W.D. (1998) 'The role of oncostatin M in animal and human connective tissue collagen turnover and its localization within the rheumatoid joint', *Arthritis & Rheumatism*, 41(10), pp. 1760-1771.
- Chadwick, B., White, D., Lader, D. and Pitts, N. (2011) *Preventive behaviour and risks to oral health - a report from the Adult Dental Health Survey 2009*. Centre, T.H.a.S.C.I. [Online]. Available at: <http://www.hscic.gov.uk/catalogue/PUB01086/adul-dent-heal-surv-summ-them-the5-2009-rep7.pdf>.
- Chan, J.L., Bullen, J., Stoyneva, V., DePaoli, A.M., Addy, C. and Mantzoros, C.S. (2005) 'Recombinant Methionyl Human Leptin Administration to Achieve High Physiologic or Pharmacologic Leptin Levels Does Not Alter Circulating Inflammatory Marker Levels in Humans with Leptin Sufficiency or Excess', *The Journal of Clinical Endocrinology & Metabolism*, 90(3), pp. 1618-1624.
- Chan, J.L., Matarese, G., Shetty, G.K., Raciti, P., Kelesidis, I., Aufiero, D., De Rosa, V., Perna, F., Fontana, S. and Mantzoros, C.S. (2006) 'Differential regulation of metabolic, neuroendocrine, and immune function by leptin in humans', *Proceedings of the National Academy of Sciences*, 103(22), pp. 8481-8486.
- Chang, H.Y., Chi, J.-T., Dudoit, S., Bondre, C., van de Rijn, M., Botstein, D. and Brown, P.O. (2002a) 'Diversity, topographic differentiation, and positional memory in human fibroblasts', *Proceedings of the National Academy of Sciences*, 99(20), pp. 12877-12882.

- Chang, H.Y., Chi, J.T., Dudoit, S., Bondre, C., van de Rijn, M., Botstein, D. and Brown, P.O. (2002b) 'Diversity, topographic differentiation, and positional memory in human fibroblasts', *Proc Natl Acad Sci U S A*, 99(20), pp. 12877-82.
- Chapple, I.L.C. and Gilbert, A.D. (2002) *Understanding Periodontal Diseases: Assessment and Diagnostic Procedures in Practice*. Quintessence Publishing Co. Ltd.
- Chen, Y.E. (2004) 'MMP-12, an old enzyme plays a new role in the pathogenesis of rheumatoid arthritis?', *Am J Pathol*, 165(4), pp. 1069-70.
- Choi, S.S., Syn, W.-K., Karaca, G.F., Omenetti, A., Moylan, C.A., Witek, R.P., Agboola, K.M., Jung, Y., Michelotti, G.A. and Diehl, A.M. (2010) 'Leptin Promotes the Myofibroblastic Phenotype in Hepatic Stellate Cells by Activating the Hedgehog Pathway', *Journal of Biological Chemistry*, 285(47), pp. 36551-36560.
- Chotjumlong, P., Khongkhunthian, S., Ongchai, S., Reutrakul, V. and Krisanaprakornkit, S. (2010) 'Human beta-defensin-3 up-regulates cyclooxygenase-2 expression and prostaglandin E2 synthesis in human gingival fibroblasts', *J Periodontal Res*, 45(4), pp. 464-70.
- Clement, K., Vaisse, C., Lahlou, N., Cabrol, S., Pelloux, V., Cassuto, D., Gourmelen, M., Dina, C., Chambaz, J., Lacorte, J.M., Basdevant, A., Bougneres, P., Lebouc, Y., Froguel, P. and Guy-Grand, B. (1998) 'A mutation in the human leptin receptor gene causes obesity and pituitary dysfunction', *Nature*, 392(6674), pp. 398-401.
- Cohen, P., Zhao, C., Cai, X., Montez, J.M., Rohani, S.C., Feinstein, P., Mombaerts, P. and Friedman, J.M. (2001) 'Selective deletion of leptin receptor in neurons leads to obesity', *J Clin Invest*, 108(8), pp. 1113-21.
- Coleman, D.L. (2010) 'A historical perspective on leptin', *Nat Med*, 16(10), pp. 1097-9.
- Coletta, R.D., Reynolds, M.A., Martelli-Junior, H., Graner, E., Almeida, O.P. and Sauk, J.J. (2002) 'Testosterone stimulates proliferation and inhibits interleukin-6 production of normal and hereditary gingival fibromatosis fibroblasts', *Oral Microbiology and Immunology*, 17(3), pp. 186-192.
- Condacci, I., Cimasoni, G., Rey, M. and Baehni, P. (1988) 'In-vitro synthesis of alpha 2-macroglobulin by human gingival fibroblasts', *Arch Oral Biol*, 33(6), pp. 407-12.
- Considine, R.V., Sinha, M.K., Heiman, M.L., Kriauciunas, A., Stephens, T.W., Nyce, M.R., Ohannesian, J.P., Marco, C.C., McKee, L.J., Bauer, T.L. and et al. (1996) 'Serum immunoreactive-leptin concentrations in normal-weight and obese humans', *N Engl J Med*, 334(5), pp. 292-5.
- Coppiari, R. and Bjorbaek, C. (2012) 'Leptin revisited: its mechanism of action and potential for treating diabetes', *Nat Rev Drug Discov*, 11(9), pp. 692-708.
- Cortez, D.M., Feldman, M.D., Mummidi, S., Valente, A.J., Steffensen, B., Vincenti, M., Barnes, J.L. and Chandrasekar, B. (2007) 'IL-17 stimulates MMP-1 expression in primary human cardiac fibroblasts via p38 MAPK- and ERK1/2-dependent C/EBP-beta, NF-kappaB, and AP-1 activation', *Am J Physiol Heart Circ Physiol*, 293(6), pp. H3356-65.
- Costa-Rodrigues, J. and Fernandes, M.H. (2011) 'Paracrine-mediated differentiation and activation of human haematopoietic osteoclast precursor cells by skin and gingival fibroblasts', *Cell Proliferation*, 44(3), pp. 264-273.
- Costea, D.E., Hills, A., Osman, A.H., Thurlow, J., Kalna, G., Huang, X., Pena Murillo, C., Parajuli, H., Suliman, S., Kulasekara, K.K., Johannessen, A.C. and Partridge, M. (2013) 'Identification of two distinct carcinoma-associated fibroblast subtypes with differential tumor-promoting abilities in oral squamous cell carcinoma', *Cancer Res*, 73(13), pp. 3888-901.
- Couturier, C. and Jockers, R. (2003) 'Activation of the leptin receptor by a ligand-induced conformational change of constitutive receptor dimers', *J Biol Chem*, 278(29), pp. 26604-11.
- Cox, S.W., Eley, B.M., Kiili, M., Asikainen, A., Tervahartiala, T. and Sorsa, T. (2006) 'Collagen degradation by interleukin-1beta-stimulated gingival fibroblasts is accompanied by release and activation of multiple matrix metalloproteinases and cysteine proteinases', *Oral Dis*, 12(1), pp. 34-40.
- Cozzolino, F., Torcia, M., Aldinucci, D., Ziche, M., Almerigogna, F., Bani, D. and Stern, D.M. (1990) 'Interleukin 1 is an autocrine regulator of human endothelial cell growth', *Proc Natl Acad Sci U S A*, 87(17), pp. 6487-91.
- Cukierman, E., Pankov, R., Stevens, D.R. and Yamada, K.M. (2001) 'Taking cell-matrix adhesions to the third dimension', *Science*, 294(5547), pp. 1708-12.

- Cury, P.R., de Araujo, V.C., Canavez, F., Furuse, C., Leite, K.R. and de Araujo, N.S. (2007) 'The effect of epidermal growth factor on matrix metalloproteinases and tissue inhibitors of metalloproteinase gene expression in cultured human gingival fibroblasts', *Arch Oral Biol*, 52(6), pp. 585-90.
- Dahan, M., Nawrocki, B., Elkaim, R., Soell, M., Bolcato-Bellemin, A.L., Birembaut, P. and Tenenbaum, H. (2001) 'Expression of matrix metalloproteinases in healthy and diseased human gingiva', *J Clin Periodontol*, 28(2), pp. 128-36.
- Dahiya, P., Kamal, R., Gupta, R., Bhardwaj, R., Chaudhary, K. and Kaur, S. (2013) 'Reactive oxygen species in periodontitis', *J Indian Soc Periodontol*, 17(4), pp. 411-6.
- Darnell, J.E., Jr. (1997) 'STATs and gene regulation', *Science*, 277(5332), pp. 1630-5.
- Darveau, R.P. (2010) 'Periodontitis: a polymicrobial disruption of host homeostasis', *Nat Rev Microbiol*, 8(7), pp. 481-90.
- Davianian, H., Bage, T., Lindberg, J., Lundeberg, J., Concha, H.Q., Sallberg Chen, M. and Yucel-Lindberg, T. (2012) 'Signaling pathways involved in the regulation of TNFalpha-induced toll-like receptor 2 expression in human gingival fibroblasts', *Cytokine*, 57(3), pp. 406-16.
- Davies, R.C., Jaedicke, K.M., Barksby, H.E., Jitprasertwong, P., Al-Shahwani, R.M., Taylor, J.J. and Preshaw, P.M. (2011) 'Do patients with aggressive periodontitis have evidence of diabetes? A pilot study', *J Periodontal Res*, 46(6), pp. 663-72.
- de Aquino, S.G., Abdollahi-Roodsaz, S., Koenders, M.I., van de Loo, F.A., Pruijn, G.J., Marijnissen, R.J., Walgreen, B., Helsen, M.M., van den Bersselaar, L.A., de Molon, R.S., Avila Campos, M.J., Cunha, F.Q., Cirelli, J.A. and van den Berg, W.B. (2014) 'Periodontal pathogens directly promote autoimmune experimental arthritis by inducing a TLR2- and IL-1-driven Th17 response', *J Immunol*, 192(9), pp. 4103-11.
- de Graaf, I.A., Olinga, P., de Jager, M.H., Merema, M.T., de Kanter, R., van de Kerkhof, E.G. and Groothuis, G.M. (2010) 'Preparation and incubation of precision-cut liver and intestinal slices for application in drug metabolism and toxicity studies', *Nat Protoc*, 5(9), pp. 1540-51.
- de Lima Oliveira, A.P., de Faveri, M., Gursky, L.C., Mestnik, M.J., Feres, M., Haffajee, A.D., Socransky, S.S. and Teles, R.P. (2012) 'Effects of periodontal therapy on GCF cytokines in generalized aggressive periodontitis subjects', *Journal of Clinical Periodontology*, 39(3), pp. 295-302.
- de Souza, A.P., Trevilatto, P.C., Scarel-Caminaga, R.M., Brito, R.B. and Line, S.R. (2003) 'MMP-1 promoter polymorphism: association with chronic periodontitis severity in a Brazilian population', *J Clin Periodontol*, 30(2), pp. 154-8.
- DeCarlo, A.A., Jr., Windsor, L.J., Bodden, M.K., Harber, G.J., Birkedal-Hansen, B. and Birkedal-Hansen, H. (1997) 'Activation and novel processing of matrix metalloproteinases by a thiol-proteinase from the oral anaerobe *Porphyromonas gingivalis*', *J Dent Res*, 76(6), pp. 1260-70.
- Delima, A.J. and Van Dyke, T.E. (2003) 'Origin and function of the cellular components in gingival crevice fluid', *Periodontology 2000*, 31(1), pp. 55-76.
- Deschaumes, C., Verneuil, L., Ertault-Daneshpouy, M., Adle-Biassette, H., Galateau, F., Ainoun, F., Micic-Polianski, J., Janin, A. and Ameisen, J.C. (2007) 'CD95 ligand-dependant endothelial cell death initiates oral mucosa damage in a murine model of acute graft versus host disease', *Lab Invest*, 87(5), pp. 417-29.
- Deshmane, S.L., Kremlev, S., Amini, S. and Sawaya, B.E. (2009) 'Monocyte chemoattractant protein-1 (MCP-1): an overview', *J Interferon Cytokine Res*, 29(6), pp. 313-26.
- Distler, J.H., Jungel, A., Huber, L.C., Seemayer, C.A., Reich, C.F., 3rd, Gay, R.E., Michel, B.A., Fontana, A., Gay, S., Pisetsky, D.S. and Distler, O. (2005) 'The induction of matrix metalloproteinase and cytokine expression in synovial fibroblasts stimulated with immune cell microparticles', *Proc Natl Acad Sci U S A*, 102(8), pp. 2892-7.
- Domeij, H., Yucel-Lindberg, T. and Modeer, T. (2002) 'Signal pathways involved in the production of MMP-1 and MMP-3 in human gingival fibroblasts', *Eur J Oral Sci*, 110(4), pp. 302-6.
- Dong, W., Xiang, J., Li, C., Cao, Z. and Huang, Z. (2009) 'Increased expression of extracellular matrix metalloproteinase inducer is associated with matrix metalloproteinase-1 and -2 in gingival tissues from patients with periodontitis', *J Periodontal Res*, 44(1), pp. 125-32.

- Dongari-Bagtzoglou, A.I., Warren, W.D., Berton, M.T. and Ebersole, J.L. (1997) 'CD40 expression by gingival fibroblasts: correlation of phenotype with function', *Int Immunol*, 9(9), pp. 1233-41.
- Du, L., Yang, P. and Ge, S. (2012) 'Stromal cell-derived factor-1 significantly induces proliferation, migration, and collagen type I expression in a human periodontal ligament stem cell subpopulation', *J Periodontol*, 83(3), pp. 379-88.
- Ducharme, A., Frantz, S., Aikawa, M., Rabkin, E., Lindsey, M., Rohde, L.E., Schoen, F.J., Kelly, R.A., Werb, Z., Libby, P. and Lee, R.T. (2000) 'Targeted deletion of matrix metalloproteinase-9 attenuates left ventricular enlargement and collagen accumulation after experimental myocardial infarction', *J Clin Invest*, 106(1), pp. 55-62.
- Dzierzewicz, Z., Szczerba, J., Lodowska, J., Wolny, D., Gruchlik, A., Orchel, A. and Weglarz, L. (2010) 'The role of *Desulfovibrio desulfuricans* lipopolysaccharides in modulation of periodontal inflammation through stimulation of human gingival fibroblasts', *Arch Oral Biol*, 55(7), pp. 515-22.
- Ebisawa, K., Kato, R., Okada, M., Sugimura, T., Latif, M.A., Hori, Y., Narita, Y., Ueda, M., Honda, H. and Kagami, H. (2011) 'Gingival and dermal fibroblasts: their similarities and differences revealed from gene expression', *J Biosci Bioeng*, 111(3), pp. 255-8.
- Ellis, A.J., Curry, V.A., Powell, E.K. and Cawston, T.E. (1994) 'The Prevention of Collagen Breakdown in Bovine Nasal Cartilage by TIMP, TIMP-2 and a Low Molecular Weight Synthetic Inhibitor', *Biochemical and Biophysical Research Communications*, 201(1), pp. 94-101.
- Emery, P., Keystone, E., Tony, H.P., Cantagrel, A., van Vollenhoven, R., Sanchez, A., Alecock, E., Lee, J. and Kremer, J. (2008) 'IL-6 receptor inhibition with tocilizumab improves treatment outcomes in patients with rheumatoid arthritis refractory to anti-tumour necrosis factor biologicals: results from a 24-week multicentre randomised placebo-controlled trial', *Ann Rheum Dis*, 67(11), pp. 1516-23.
- Eskan, M.A., Benakanakere, M.R., Rose, B.G., Zhang, P., Zhao, J., Stathopoulou, P., Fujioka, D. and Kinane, D.F. (2008) 'Interleukin-1beta modulates proinflammatory cytokine production in human epithelial cells', *Infect Immun*, 76(5), pp. 2080-9.
- Fanjul-Fernandez, M., Folgueras, A.R., Cabrera, S. and Lopez-Otin, C. (2010) 'Matrix metalloproteinases: evolution, gene regulation and functional analysis in mouse models', *Biochim Biophys Acta*, 1803(1), pp. 3-19.
- Fantuzzi, G. and Faggioni, R. (2000) 'Leptin in the regulation of immunity, inflammation, and hematopoiesis', *J Leukoc Biol*, 68(4), pp. 437-46.
- Faria Morandini, A.C., Chaves Souza, P.P., Ramos-Junior, E.S., Brozoski, D.T., Sipert, C.R., Souza Costa, C.A. and Santos, C.F. (2012) 'Toll-Like Receptor 2 Knockdown Modulates Interleukin (IL)-6 and IL-8 but not Stromal Derived Factor-1 (SDF-1/CXCL12) in Human Periodontal Ligament and Gingival Fibroblasts', *Journal of Periodontology*, pp. 1-11.
- Farndale, R.W., Buttle, D.J. and Barrett, A.J. (1986) 'Improved quantitation and discrimination of sulphated glycosaminoglycans by use of dimethylmethylene blue', *Biochimica et Biophysica Acta (BBA) - General Subjects*, 883(2), pp. 173-177.
- Farooqi, I.S., Matarese, G., Lord, G.M., Keogh, J.M., Lawrence, E., Agwu, C., Sanna, V., Jebb, S.A., Perna, F., Fontana, S., Lechler, R.I., DePaoli, A.M. and O'Rahilly, S. (2002) 'Beneficial effects of leptin on obesity, T cell hyporesponsiveness, and neuroendocrine/metabolic dysfunction of human congenital leptin deficiency', *J Clin Invest*, 110(8), pp. 1093-103.
- Feghali, K., Iwasaki, K., Tanaka, K., Komaki, M., Machigashira, M., Ishikawa, I. and Izumi, Y. (2009) 'Human gingival fibroblasts release high-mobility group box-1 protein through active and passive pathways', *Oral Microbiology and Immunology*, 24(4), pp. 292-298.
- Fernandez-Riejos, P., Najib, S., Santos-Alvarez, J., Martin-Romero, C., Perez-Perez, A., Gonzalez-Yanes, C. and Sanchez-Margalet, V. (2010) 'Role of leptin in the activation of immune cells', *Mediators Inflamm*, 2010, p. 568343.
- Fernandez, E.J. and Lolis, E. (2002) 'Structure, function, and inhibition of chemokines', *Annu Rev Pharmacol Toxicol*, 42, pp. 469-99.
- Fichter, M., Korner, U., Schomburg, J., Jennings, L., Cole, A.A. and Mollenhauer, J. (2006) 'Collagen degradation products modulate matrix metalloproteinase expression in cultured articular chondrocytes', *J Orthop Res*, 24(1), pp. 63-70.

- Fowler, C.B., Man, Y.G. and Mason, J.T. (2014) 'An ultra-sensitive immunoassay for quantifying biomarkers in breast tumor tissue', *J Cancer*, 5(2), pp. 115-24.
- Friedman, J.M. and Halaas, J.L. (1998) 'Leptin and the regulation of body weight in mammals', *Nature*, 395(6704), pp. 763-70.
- Gamber, K.M., Huo, L., Ha, S., Hairston, J.E., Greeley, S. and Bjorbaek, C. (2012) 'Over-expression of leptin receptors in hypothalamic POMC neurons increases susceptibility to diet-induced obesity', *PLoS One*, 7(1), p. e30485.
- Gangadhar, V., Ramesh, A. and Thomas, B. (2011) 'Correlation between leptin and the health of the gingiva: a predictor of medical risk', *Indian J Dent Res*, 22(4), pp. 537-41.
- Gao, Q. and Horvath, T.L. (2008) 'Cross-talk between estrogen and leptin signaling in the hypothalamus', *Am J Physiol Endocrinol Metab*, 294(5), pp. E817-26.
- Ge, H., Huang, L., Pourbahrami, T. and Li, C. (2002) 'Generation of soluble leptin receptor by ectodomain shedding of membrane-spanning receptors in vitro and in vivo', *J Biol Chem*, 277(48), pp. 45898-903.
- Glasow, A., Kiess, W., Anderegg, U., Berthold, A., Bottner, A. and Kratzsch, J. (2001) 'Expression of leptin (Ob) and leptin receptor (Ob-R) in human fibroblasts: regulation of leptin secretion by insulin', *J Clin Endocrinol Metab*, 86(9), pp. 4472-9.
- Gong, Y., Ishida-Takahashi, R., Villanueva, E.C., Fingar, D.C., Munzberg, H. and Myers, M.G., Jr. (2007) 'The long form of the leptin receptor regulates STAT5 and ribosomal protein S6 via alternate mechanisms', *J Biol Chem*, 282(42), pp. 31019-27.
- Gorres, K.L. and Raines, R.T. (2010) 'Prolyl 4-hydroxylase', *Crit Rev Biochem Mol Biol*, 45(2), pp. 106-24.
- Gosset, M., Pigenet, A., Salvat, C., Berenbaum, F. and Jacques, C. (2010) 'Inhibition of matrix metalloproteinase-3 and-13 synthesis induced by IL-1 β in chondrocytes from mice lacking microsomal prostaglandin E synthase-1', *Journal of Immunology*, 185(10), pp. 6244-6252.
- Gove, M.E., Rhodes, D.H., Pini, M., van Baal, J.W., Sennello, J.A., Fayad, R., Cabay, R.J., Myers, M.G., Jr. and Fantuzzi, G. (2009) 'Role of leptin receptor-induced STAT3 signaling in modulation of intestinal and hepatic inflammation in mice', *J Leukoc Biol*, 85(3), pp. 491-6.
- Grayson, R., Douglas, C.W., Heath, J., Rawlinson, A. and Evans, G.S. (2003) 'Activation of human matrix metalloproteinase 2 by gingival crevicular fluid and *Porphyromonas gingivalis*', *J Clin Periodontol*, 30(6), pp. 542-50.
- Griffiths, G.S., Wilton, J.M. and Curtis, M.A. (1997) 'Permeability of the gingival tissues to IgM during an experimental gingivitis study in man', *Arch Oral Biol*, 42(2), pp. 129-36.
- Grodecki-Pena, A., Knapp, A., Salvador, A.M. and Alcaide, P. (2013) 'Contribution of E-selectin Ligands and the Chemokine CCL20 to Th17 Lymphocyte Rolling and Transendothelial Migration', *FASEB J*, 27, p. 57.6.
- Grotle, M., Hagen, K.B., Natvig, B., Dahl, F.A. and Kvien, T.K. (2008) 'Obesity and osteoarthritis in knee, hip and/or hand: an epidemiological study in the general population with 10 years follow-up', *BMC Musculoskelet Disord*, 9, p. 132.
- Gruen, M.L., Hao, M., Piston, D.W. and Hasty, A.H. (2007) 'Leptin requires canonical migratory signaling pathways for induction of monocyte and macrophage chemotaxis', *Am J Physiol Cell Physiol*, 293(5), pp. C1481-8.
- Gundala, R., Vk, C. and K, R. (2012) 'Association of Leptin in Periodontitis and Acute Myocardial Infarction', *J Periodontol*.
- Guo, F., Carter, D.E., Mukhopadhyay, A. and Leask, A. (2011) 'Gingival fibroblasts display reduced adhesion and spreading on extracellular matrix: a possible basis for scarless tissue repair?', *PLoS One*, 6(11), p. e27097.
- Guo, Y., Nguyen, K.-A. and Potempa, J. (2010) 'Dichotomy of gingipains action as virulence factors: from cleaving substrates with the precision of a surgeon's knife to a meat chopper-like brutal degradation of proteins', *Periodontology 2000*, 54(1), pp. 15-44.
- Gutiérrez-Venegas, G. and Arreguín-Cano, J.A. (2011) 'Bradykinin promotes TLR2 expression in human gingival fibroblasts', *International Immunopharmacology*, 11(12), pp. 2079-2085.
- Gutsmann, T., Müller, M., Carroll, S.F., MacKenzie, R.C., Wiese, A. and Seydel, U. (2001) 'Dual Role of Lipopolysaccharide (LPS)-Binding Protein in Neutralization of LPS and Enhancement of LPS-Induced Activation of Mononuclear Cells', *Infection and Immunity*, 69(11), pp. 6942-6950.

- Haase, H.R. and Bartold, P.M. (2001) 'Enamel matrix derivative induces matrix synthesis by cultured human periodontal fibroblast cells', *J Periodontol*, 72(3), pp. 341-8.
- Haglund, E., Sulkowska, J.I., He, Z., Feng, G.S., Jennings, P.A. and Onuchic, J.N. (2012) 'The unique cysteine knot regulates the pleiotropic hormone leptin', *PLoS One*, 7(9), p. e45654.
- Hajishengallis, G. (2010) 'Complement and periodontitis', *Biochemical Pharmacology*, 80(12), pp. 1992-2001.
- Han, X. and Amar, S. (2002) 'Identification of Genes Differentially Expressed in Cultured Human Periodontal Ligament Fibroblasts vs. Human Gingival Fibroblasts by DNA Microarray Analysis', *Journal of Dental Research*, 81(6), pp. 399-405.
- Han, Z., Boyle, D.L., Chang, L., Bennett, B., Karin, M., Yang, L., Manning, A.M. and Firestein, G.S. (2001) 'c-Jun N-terminal kinase is required for metalloproteinase expression and joint destruction in inflammatory arthritis', *J Clin Invest*, 108(1), pp. 73-81.
- Haniffa, M.A., Collin, M.P., Buckley, C.D. and Dazzi, F. (2009) 'Mesenchymal stem cells: the fibroblasts' new clothes?', *Haematologica*, 94(2), pp. 258-263.
- Hannas, A.R., Pereira, J.C., Granjeiro, J.M. and Tjaderhane, L. (2007) 'The role of matrix metalloproteinases in the oral environment', *Acta Odontol Scand*, 65(1), pp. 1-13.
- Hasturk, H., Kantarci, A., Ohira, T., Arita, M., Ebrahimi, N., Chiang, N., Petasis, N.A., Levy, B.D., Serhan, C.N. and Van Dyke, T.E. (2006) 'RvE1 protects from local inflammation and osteoclast-mediated bone destruction in periodontitis', *FASEB J*, 20(2), pp. 401-3.
- He, M., Su, H., Gao, W., Johansson, S.M., Liu, Q., Wu, X., Liao, J., Young, A.A., Bartfai, T. and Wang, M.W. (2010) 'Reversal of obesity and insulin resistance by a non-peptidic glucagon-like peptide-1 receptor agonist in diet-induced obese mice', *PLoS One*, 5(12), p. e14205.
- He, Z.W., Qin, Y.H., Wang, Z.W., Chen, Y., Shen, Q. and Dai, S.M. (2013) 'HMGB1 acts in synergy with lipopolysaccharide in activating rheumatoid synovial fibroblasts via p38 MAPK and NF-kappaB signaling pathways', *Mediators Inflamm*, 2013, p. 596716.
- Heasman, P.A., Preshaw, P.M. and Robertson, P. (2004) *Successful Periodontal Therapy A Non-Surgical Approach*. Quintessence Publishing Co. Ltd.
- Heath, J.K., Gowen, M., Meikle, M.C. and Reynolds, J.J. (1982) 'Human gingival tissues in culture synthesize three metalloproteinases and a metalloproteinase inhibitor', *Journal of Periodontal Research*, 17(2), pp. 183-190.
- Heitz-Mayfield, L.J., Trombelli, L., Heitz, F., Needleman, I. and Moles, D. (2002) 'A systematic review of the effect of surgical debridement vs non-surgical debridement for the treatment of chronic periodontitis', *J Clin Periodontol*, 29 Suppl 3, pp. 92-102; discussion 160-2.
- Henderson, N., Markwick, L.J., Elshaw, S.R., Freyer, A.M., Knox, A.J. and Johnson, S.R. (2007) 'Collagen I and thrombin activate MMP-2 by MMP-14-dependent and -independent pathways: implications for airway smooth muscle migration', *Am J Physiol Lung Cell Mol Physiol*, 292(4), pp. L1030-8.
- Heng, E.C., Huang, Y., Black, S.A., Jr. and Trackman, P.C. (2006) 'CCN2, connective tissue growth factor, stimulates collagen deposition by gingival fibroblasts via α 3 and α 6 and β 1 integrins', *J Cell Biochem*, 98(2), pp. 409-20.
- Henklova, P., Vrzal, R., Papouskova, B., Bednar, P., Jancova, P., Anzenbacherova, E., Ulrichova, J., Maurel, P., Pavsek, P. and Dvorak, Z. (2008) 'SB203580, a pharmacological inhibitor of p38 MAP kinase transduction pathway activates ERK and JNK MAP kinases in primary cultures of human hepatocytes', *European Journal of Pharmacology*, 593(1-3), pp. 16-23.
- Herath, T.D., Wang, Y., Seneviratne, C.J., Darveau, R.P., Wang, C.Y. and Jin, L. (2013) 'The expression and regulation of matrix metalloproteinase-3 is critically modulated by Porphyromonas gingivalis lipopolysaccharide with heterogeneous lipid A structures in human gingival fibroblasts', *BMC Microbiol*, 13, p. 73.
- Hess, J., Angel, P. and Schorpp-Kistner, M. (2004) 'AP-1 subunits: quarrel and harmony among siblings', *J Cell Sci*, 117(Pt 25), pp. 5965-73.
- Hill, J.W., Williams, K.W., Ye, C., Luo, J., Balthasar, N., Coppari, R., Cowley, M.A., Cantley, L.C., Lowell, B.B. and Elmquist, J.K. (2008) 'Acute effects of leptin require PI3K signaling in hypothalamic proopiomelanocortin neurons in mice', *J Clin Invest*, 118(5), pp. 1796-805.
- Homayounfar, K., Meis, J., Jung, K., Klosterhalfen, B., Sprenger, T., Conradi, L.C., Langer, C. and Becker, H. (2012) 'Ultrasonic scalpel causes greater depth of soft tissue necrosis compared

to monopolar electrocautery at standard power level settings in a pig model', *BMC Surg*, 12, p. 3.

Hosokawa, Y., Hosokawa, I., Ozaki, K., Nakae, H. and Matsuo, T. (2008) 'CC Chemokine ligand 17 in periodontal diseases: expression in diseased tissues and production by human gingival fibroblasts', *Journal of Periodontal Research*, 43(4), pp. 471-477.

Hosokawa, Y., Hosokawa, I., Ozaki, K., Nakae, H. and Matsuo, T. (2009) 'Cytokines differentially regulate CXCL10 production by interferon-gamma-stimulated or tumor necrosis factor-alpha-stimulated human gingival fibroblasts', *J Periodontal Res*, 44(2), pp. 225-31.

Hosokawa, Y., Hosokawa, I., Ozaki, K., Nakae, H. and Matsuo, T. (2010a) 'Oncostatin M synergistically induces CXCL10 and ICAM-1 expression in IL-1beta-stimulated-human gingival fibroblasts', *J Cell Biochem*, 111(1), pp. 40-8.

Hosokawa, Y., Hosokawa, I., Ozaki, K., Nakae, H. and Matsuo, T. (2010b) 'TNFSF14 coordinately enhances CXCL10 and CXCL11 productions from IFN- γ -stimulated human gingival fibroblasts', *Molecular Immunology*, 47(4), pp. 666-670.

Hotamisligil, G.S. (2006) 'Inflammation and metabolic disorders', *Nature*, 444(7121), pp. 860-7.

Hsu, A., Aronoff, D.M., Phipps, J., Goel, D. and Mancuso, P. (2007) 'Leptin improves pulmonary bacterial clearance and survival in ob/ob mice during pneumococcal pneumonia', *Clin Exp Immunol*, 150(2), pp. 332-9.

Huan, J.N., Li, J., Han, Y., Chen, K., Wu, N. and Zhao, A.Z. (2003) 'Adipocyte-selective reduction of the leptin receptors induced by antisense RNA leads to increased adiposity, dyslipidemia, and insulin resistance', *J Biol Chem*, 278(46), pp. 45638-50.

Huang da, W., Sherman, B.T. and Lempicki, R.A. (2009) 'Bioinformatics enrichment tools: paths toward the comprehensive functional analysis of large gene lists', *Nucleic Acids Res*, 37(1), pp. 1-13.

Hui, W., Litherland, G.J., Elias, M.S., Kitson, G.I., Cawston, T.E., Rowan, A.D. and Young, D.A. (2012) 'Leptin produced by joint white adipose tissue induces cartilage degradation via upregulation and activation of matrix metalloproteinases', *Ann Rheum Dis*, 71(3), pp. 455-62.

Huttner, E.A., Machado, D.C., De Oliveira, R.B., Antunes, A.G.F. and Hebling, E. (2009) 'Effects of human aging on periodontal tissues', *Special Care in Dentistry*, 29(4), pp. 149-155.

Ide, S., Tokuyama, R., Davaadorj, P., Shimoizuma, M., Kumasaka, S., Tatehara, S. and Satomura, K. (2011) 'Leptin and vascular endothelial growth factor regulate angiogenesis in tooth germs', *Histochemistry and Cell Biology*, 135(3), pp. 281-292.

Imatani, T., Kato, T. and Okuda, K. (2001) 'Production of inflammatory cytokines by human gingival fibroblasts stimulated by cell-surface preparations of *Porphyromonas gingivalis*', *Oral Microbiology and Immunology*, 16(2), pp. 65-72.

Inc., I. (2014) *Direct Hybridisation assay*. Available at: <http://www.illumina.com/technology/beadarray-technology/direct-hybridization-assay.ilmn>.

Irwin, C.R., Picardo, M., Ellis, I., Sloan, P., Grey, A., McGurk, M. and Schor, S.L. (1994) 'Inter- and intra-site heterogeneity in the expression of fetal-like phenotypic characteristics by gingival fibroblasts: potential significance for wound healing', *J Cell Sci*, 107 (Pt 5), pp. 1333-46.

Itoh, M., Murata, T., Suzuki, T., Shindoh, M., Nakajima, K., Imai, K. and Yoshida, K. (2006) 'Requirement of STAT3 activation for maximal collagenase-1 (MMP-1) induction by epidermal growth factor and malignant characteristics in T24 bladder cancer cells', *Oncogene*, 25(8), pp. 1195-204.

Iwayama, T., Yanagita, M., Mori, K., Sawada, K., Ozasa, M., Kubota, M., Miki, K., Kojima, Y., Takedachi, M., Kitamura, M., Shimabukuro, Y., Hashikawa, T. and Murakami, S. (2012) 'Adiponectin regulates functions of gingival fibroblasts and periodontal ligament cells', *Journal of Periodontal Research*, 47(5), pp. 563-571.

Jaedicke, K.M. (2010) 'Adipokines and myeloid cell immune responses in periodontal disease and diabetes. ', *PhD Thesis. Newcastle University, UK*.

Jaedicke, K.M., Roythorne, A., Padget, K., Todryk, S., Preshaw, P.M. and Taylor, J.J. (2013) 'Leptin up-regulates TLR2 in human monocytes', *J Leukoc Biol*, 93(4), pp. 561-71.

Jaffe, T. and Schwartz, B. (2008) 'Leptin promotes motility and invasiveness in human colon cancer cells by activating multiple signal-transduction pathways', *Int J Cancer*, 123(11), pp. 2543-56.

- Jager, J., Corcelle, V., Grémeaux, T., Laurent, K., Waget, A., Pagès, G., Binétruy, B., Le Marchand-Brustel, Y., Burcelin, R., Bost, F. and Tanti, J. (2011) 'Deficiency in the extracellular signal-regulated kinase 1 (ERK1) protects leptin-deficient mice from insulin resistance without affecting obesity', *Diabetologia*, 54(1), pp. 180-189.
- Jeremy, J.Y. and Thomas, A.C. (2010) 'Animal models for studying neointima formation', *Curr Vasc Pharmacol*, 8(2), pp. 198-219.
- Jin, J., Sundararaj, K.P., Samuvel, D.J., Zhang, X., Li, Y., Lu, Z., Lopes-Virella, M.F. and Huang, Y. (2012) 'Different signaling mechanisms regulating IL-6 expression by LPS between gingival fibroblasts and mononuclear cells: seeking the common target', *Clinical Immunology*, 143(2), pp. 188-199.
- Jin, Q., Cirelli, J.A., Park, C.H., Sugai, J.V., Taba, M., Jr., Kostenuik, P.J. and Giannobile, W.V. (2007) 'RANKL inhibition through osteoprotegerin blocks bone loss in experimental periodontitis', *J Periodontol*, 78(7), pp. 1300-8.
- Jitprasertwong, P., Jaedicke, K.M., Nile, C.J., Preshaw, P.M. and Taylor, J.J. (2014) 'Leptin enhances the secretion of interleukin (IL)-18, but not IL-1beta, from human monocytes via activation of caspase-1', *Cytokine*, 65(2), pp. 222-30.
- Johnson, R.B. and Serio, F.G. (2001) 'Leptin within healthy and diseased human gingiva', *J Periodontol*, 72(9), pp. 1254-7.
- Johnson, W.E., Li, C. and Rabinovic, A. (2007) 'Adjusting batch effects in microarray expression data using empirical Bayes methods', *Biostatistics*, 8(1), pp. 118-27.
- Jonsson, D., Nebel, D., Bratthall, G. and Nilsson, B.O. (2011) 'The human periodontal ligament cell: a fibroblast-like cell acting as an immune cell', *J Periodontal Res*, 46(2), pp. 153-7.
- Jung, D.W., Che, Z.M., Kim, J., Kim, K., Kim, K.Y., Williams, D. and Kim, J. (2010) 'Tumor-stromal crosstalk in invasion of oral squamous cell carcinoma: a pivotal role of CCL7', *Int J Cancer*, 127(2), pp. 332-44.
- Jung, D.Y., Lee, H., Jung, B.Y., Ock, J., Lee, M.S., Lee, W.H. and Suk, K. (2005) 'TLR4, but not TLR2, signals autoregulatory apoptosis of cultured microglia: a critical role of IFN-beta as a decision maker', *J Immunol*, 174(10), pp. 6467-76.
- Kalluri, R. and Zeisberg, M. (2006) 'Fibroblasts in cancer', *Nat Rev Cancer*, 6(5), pp. 392-401.
- Kanda-Nakamura, C., Izumi, Y. and Sueda, T. (1996) 'Increased Expression of Interleukin-1 Receptors on Fibroblasts Derived From Inflamed Gingiva*', *Journal of Periodontology*, 67(12), pp. 1267-1273.
- Karthikeyan, B.V. and Pradeep, A.R. (2007a) 'Gingival crevicular fluid and serum leptin: their relationship to periodontal health and disease', *J Clin Periodontol*, 34(6), pp. 467-72.
- Karthikeyan, B.V. and Pradeep, A.R. (2007b) 'Leptin levels in gingival crevicular fluid in periodontal health and disease', *J Periodontal Res*, 42(4), pp. 300-4.
- Kato, H., Ueki, S., Kamada, R., Kihara, J., Yamauchi, Y., Suzuki, T., Takeda, M., Itoga, M., Chihara, M., Ito, W., Kayaba, H. and Chihara, J. (2011) 'Leptin Has a Priming Effect on Eotaxin-Induced Human Eosinophil Chemotaxis', *International Archives of Allergy and Immunology*, 155(4), pp. 335-344.
- Kelesidis, T., Kelesidis, I., Chou, S. and Mantzoros, C.S. (2010) 'Narrative review: the role of leptin in human physiology: emerging clinical applications', *Ann Intern Med*, 152(2), pp. 93-100.
- Kent, L.W., Rahemtulla, F. and Michalek, S.M. (1999) 'Interleukin (IL)-1 and Porphyromonas gingivalis lipopolysaccharide stimulation of IL-6 production by fibroblasts derived from healthy or periodontally diseased human gingival tissue', *J Periodontol*, 70(3), pp. 274-82.
- Kessenbrock, K., Plaks, V. and Werb, Z. (2010) 'Matrix metalloproteinases: regulators of the tumor microenvironment', *Cell*, 141(1), pp. 52-67.
- Khaled, M., Shibani, N.-A., Labban, N., Baterseh, G., Song, F., Ruby, J. and Windsor, L.J. (2013) 'The Effects of Resolvin D1 on Human Gingival Fibroblasts Cell Survival and Cytokine Expression', *Journal of Periodontology*, pp. 1-12.
- Kida, Y., Kobayashi, M., Suzuki, T., Takeshita, A., Okamatsu, Y., Hanazawa, S., Yasui, T. and Hasegawa, K. (2005) 'Interleukin-1 stimulates cytokines, prostaglandin E2 and matrix metalloproteinase-1 production via activation of MAPK/AP-1 and NF-κB in human gingival fibroblasts', *Cytokine*, 29(4), pp. 159-168.

- Kiguchi, N., Maeda, T., Kobayashi, Y., Fukazawa, Y. and Kishioka, S. (2009) 'Leptin enhances CC-chemokine ligand expression in cultured murine macrophage', *Biochem Biophys Res Commun*, 384(3), pp. 311-5.
- Kiili, M., Cox, S.W., Chen, H.Y., Wahlgren, J., Maisi, P., Eley, B.M., Salo, T. and Sorsa, T. (2002) 'Collagenase-2 (MMP-8) and collagenase-3 (MMP-13) in adult periodontitis: molecular forms and levels in gingival crevicular fluid and immunolocalisation in gingival tissue', *J Clin Periodontol*, 29(3), pp. 224-32.
- Kiji, M., Nagasawa, T., Hormdee, D., Yashiro, R., Kobayashi, H., Noguchi, K., Nitta, H., Izumi, Y. and Ishikawa, I. (2007) 'Internal prostaglandin synthesis augments osteoprotegerin production in human gingival fibroblasts stimulated by lipopolysaccharide', *Clin Exp Immunol*, 149(2), pp. 327-34.
- Kim, D.-S., Kim, J.-H., Lee, G.-H., Kim, H.-T., Lim, J.M., Chae, S.-W., Chae, H.-J. and Kim, H.-R. (2010a) 'p38 Mitogen-Activated Protein Kinase is Involved in Endoplasmic Reticulum Stress-Induced Cell Death and Autophagy in Human Gingival Fibroblasts', *Biological and Pharmaceutical Bulletin*, 33(4), pp. 545-549.
- Kim, D.M., Ramoni, M.F., Nevins, M. and Fiorellini, J.P. (2006) 'The gene expression profile in refractory periodontitis patients', *J Periodontol*, 77(6), pp. 1043-50.
- Kim, K.S., Choi, H.M., Oh da, H., Kim, C., Jeong, J.S., Yoo, M.C. and Yang, H.I. (2010b) 'Effect of taurine chloramine on the production of matrix metalloproteinases (MMPs) in adiponectin- or IL-1beta-stimulated fibroblast-like synoviocytes', *J Biomed Sci*, 17 Suppl 1, p. S27.
- Kim, S.J. (2010) 'Leptin potentiates Prevotella intermedia lipopolysaccharide-induced production of TNF-alpha in monocyte-derived macrophages', *J Periodontal Implant Sci*, 40(3), pp. 119-24.
- Kim, S.J., Chung, Y.K., Chung, T.W., Kim, J.R., Moon, S.K., Kim, C.H. and Park, Y.G. (2009) 'Regulation of matrix metalloproteinase-9 expression between gingival fibroblast cells from old and young rats', *Biochem Biophys Res Commun*, 378(2), pp. 152-6.
- King, N.J. and Thomas, S.R. (2007) 'Molecules in focus: indoleamine 2,3-dioxygenase', *Int J Biochem Cell Biol*, 39(12), pp. 2167-72.
- Kline, A.D., Becker, G.W., Churgay, L.M., Landen, B.E., Martin, D.K., Muth, W.L., Rathnachalam, R., Richardson, J.M., Schoner, B., Ulmer, M. and Hale, J.E. (1997) 'Leptin is a four-helix bundle: secondary structure by NMR', *FEBS Lett*, 407(2), pp. 239-42.
- Ko, S.D., Page, R.C. and Narayanan, A.S. (1977) 'Fibroblast heterogeneity and prostaglandin regulation of subpopulations', *Proceedings of the National Academy of Sciences*, 74(8), pp. 3429-3432.
- Kolb, H. and Mandrup-Poulsen, T. (2010) 'The global diabetes epidemic as a consequence of lifestyle-induced low-grade inflammation', *Diabetologia*, 53(1), pp. 10-20.
- Kornman, K.S. (2008) 'Mapping the pathogenesis of periodontitis: a new look', *J Periodontol*, 79(8 Suppl), pp. 1560-8.
- Koshy, P.J., Lundy, C.J., Rowan, A.D., Porter, S., Edwards, D.R., Hogan, A., Clark, I.M. and Cawston, T.E. (2002) 'The modulation of matrix metalloproteinase and ADAM gene expression in human chondrocytes by interleukin-1 and oncostatin M: a time-course study using real-time quantitative reverse transcription-polymerase chain reaction', *Arthritis Rheum*, 46(4), pp. 961-7.
- Koskinen, A., Vuolteenaho, K., Nieminen, R., Moilanen, T. and Moilanen, E. (2011) 'Leptin enhances MMP-1, MMP-3 and MMP-13 production in human osteoarthritic cartilage and correlates with MMP-1 and MMP-3 in synovial fluid from OA patients', *Clin Exp Rheumatol*, 29(1), pp. 57-64.
- Kragstrup, T.W., Otkjaer, K., Holm, C., Jorgensen, A., Hokland, M., Iversen, L. and Deleuran, B. (2008) 'The expression of IL-20 and IL-24 and their shared receptors are increased in rheumatoid arthritis and spondyloarthritis', *Cytokine*, 41(1), pp. 16-23.
- Kraus, D., Winter, J., Jepsen, S., Jäger, A., Meyer, R. and Deschner, J. (2012) 'Interactions of Adiponectin and Lipopolysaccharide from *Porphyromonas gingivalis* on Human Oral Epithelial Cells', *PLoS ONE*, 7(2), p. e30716.
- Kronfeld-Schor, N., Richardson, C., Silvia, B.A., Kunz, T.H. and Widmaier, E.P. (2000) 'Dissociation of leptin secretion and adiposity during prehibernatory fattening in little brown bats', *Am J Physiol Regul Integr Comp Physiol*, 279(4), pp. R1277-81.

- Kubagawa, H., Oka, S., Kubagawa, Y., Torii, I., Takayama, E., Kang, D.W., Gartland, G.L., Bertoli, L.F., Mori, H., Takatsu, H., Kitamura, T., Ohno, H. and Wang, J.Y. (2009) 'Identity of the elusive IgM Fc receptor (FcmuR) in humans', *J Exp Med*, 206(12), pp. 2779-93.
- Kuo, P.J., Tu, H.P., Chin, Y.T., Lu, S.H., Chiang, C.Y., Chen, R.Y. and Fu, E. (2012) 'Cyclosporine-A inhibits MMP-2 and -9 activities in the presence of Porphyromonas gingivalis lipopolysaccharide: an experiment in human gingival fibroblast and U937 macrophage co-culture', *Journal of Periodontal Research*, 47(4), pp. 431-438.
- Lee, H.M., Ciancio, S.G., Tuter, G., Ryan, M.E., Komaroff, E. and Golub, L.M. (2004a) 'Subantimicrobial dose doxycycline efficacy as a matrix metalloproteinase inhibitor in chronic periodontitis patients is enhanced when combined with a non-steroidal anti-inflammatory drug', *J Periodontol*, 75(3), pp. 453-63.
- Lee, J.Y., Lee, Y.M., Shin, S.Y., Seol, Y.J., Ku, Y., Rhyu, I.C., Chung, C.P. and Han, S.B. (2004b) 'Effect of subantimicrobial dose doxycycline as an effective adjunct to scaling and root planing', *J Periodontol*, 75(11), pp. 1500-8.
- Leek, J.T. and Storey, J.D. (2007) 'Capturing heterogeneity in gene expression studies by surrogate variable analysis', *PLoS Genet*, 3(9), pp. 1724-35.
- Leivonen, S.-K., Chantry, A., Häkkinen, L., Han, J. and Kähäri, V.-M. (2002) 'Smad3 Mediates Transforming Growth Factor- β -induced Collagenase-3 (Matrix Metalloproteinase-13) Expression in Human Gingival Fibroblasts: EVIDENCE FOR CROSS-TALK BETWEEN Smad3 AND p38 SIGNALING PATHWAYS', *Journal of Biological Chemistry*, 277(48), pp. 46338-46346.
- Leivonen, S.K., Lazaridis, K., Decock, J., Chantry, A., Edwards, D.R. and Kahari, V.M. (2013) 'TGF-beta-elicited induction of tissue inhibitor of metalloproteinases (TIMP)-3 expression in fibroblasts involves complex interplay between Smad3, p38alpha, and ERK1/2', *PLoS One*, 8(2), p. e57474.
- Lekic, P.C., Pender, N. and McCulloch, C.A.G. (1997) 'Is Fibroblast Heterogeneity Relevant To the Health, Diseases, and Treatments of Periodontal Tissues?', *Critical Reviews in Oral Biology & Medicine*, 8(3), pp. 253-268.
- Li, W., Zhu, W., Hou, J., Huang, B., Liu, K. and Meng, H. (2014) 'Leptin and its receptor expression in dental and periodontal tissues of primates', *Cell and Tissue Research*, 355(1), pp. 181-188.
- Liboon, J., Funkhouser, W. and Terris, D.J. (1997) 'A comparison of mucosal incisions made by scalpel, CO2 laser, electrocautery, and constant-voltage electrocautery', *Otolaryngol Head Neck Surg*, 116(3), pp. 379-85.
- Lin, S.J., Chen, Y.L., Kuo, M.Y., Li, C.L. and Lu, H.K. (2005) 'Measurement of gp130 cytokines oncostatin M and IL-6 in gingival crevicular fluid of patients with chronic periodontitis', *Cytokine*, 30(4), pp. 160-7.
- Litherland, G.J., Dixon, C., Lakey, R.L., Robson, T., Jones, D., Young, D.A., Cawston, T.E. and Rowan, A.D. (2008) 'Synergistic collagenase expression and cartilage collagenolysis are phosphatidylinositol 3-kinase/Akt signaling-dependent', *J Biol Chem*, 283(21), pp. 14221-9.
- Liu, J., Minemoto, Y. and Lin, A. (2004) 'c-Jun N-terminal protein kinase 1 (JNK1), but not JNK2, is essential for tumor necrosis factor alpha-induced c-Jun kinase activation and apoptosis', *Mol Cell Biol*, 24(24), pp. 10844-56.
- Liu, R., Bal, H.S., Desta, T., Krothapalli, N., Alyassi, M., Luan, Q. and Graves, D.T. (2006) 'Diabetes enhances periodontal bone loss through enhanced resorption and diminished bone formation', *J Dent Res*, 85(6), pp. 510-4.
- Liu, Y.C., Lerner, U.H. and Teng, Y.T. (2010) 'Cytokine responses against periodontal infection: protective and destructive roles', *Periodontol 2000*, 52(1), pp. 163-206.
- Livak, K.J. and Schmittgen, T.D. (2001) 'Analysis of Relative Gene Expression Data Using Real-Time Quantitative PCR and the 2- $\Delta\Delta$ CT Method', *Methods*, 25(4), pp. 402-408.
- Loffek, S., Schilling, O. and Franzke, C.W. (2011) 'Series "matrix metalloproteinases in lung health and disease": Biological role of matrix metalloproteinases: a critical balance', *Eur Respir J*, 38(1), pp. 191-208.
- Lohi, J., Lehti, K., Valtanen, H., Parks, W.C. and Keski-Oja, J. (2000) 'Structural analysis and promoter characterization of the human membrane-type matrix metalloproteinase-1 (MT1-MMP) gene', *Gene*, 242(1-2), pp. 75-86.

- Loo, W.T., Wang, M., Jin, L.J., Cheung, M.N. and Li, G.R. (2011) 'Association of matrix metalloproteinase (MMP-1, MMP-3 and MMP-9) and cyclooxygenase-2 gene polymorphisms and their proteins with chronic periodontitis', *Arch Oral Biol*, 56(10), pp. 1081-90.
- Lord, G.M., Matarese, G., Howard, J.K., Baker, R.J., Bloom, S.R. and Lechler, R.I. (1998) 'Leptin modulates the T-cell immune response and reverses starvation-induced immunosuppression', *Nature*, 394(6696), pp. 897-901.
- Lowe, S.W. and Lin, A.W. (2000) 'Apoptosis in cancer', *Carcinogenesis*, 21(3), pp. 485-95.
- Lu, P., Takai, K., Weaver, V.M. and Werb, Z. (2011) 'Extracellular matrix degradation and remodeling in development and disease', *Cold Spring Harb Perspect Biol*, 3(12).
- Lu, Y.C., Yeh, W.C. and Ohashi, P.S. (2008) 'LPS/TLR4 signal transduction pathway', *Cytokine*, 42(2), pp. 145-51.
- MacNaul, K.L., Chartrain, N., Lark, M., Tocci, M.J. and Hutchinson, N.I. (1990) 'Discoordinate expression of stromelysin, collagenase, and tissue inhibitor of metalloproteinases-1 in rheumatoid human synovial fibroblasts. Synergistic effects of interleukin-1 and tumor necrosis factor-alpha on stromelysin expression', *J Biol Chem*, 265(28), pp. 17238-45.
- Madianos, P.N., Bobetsis, Y.A. and Kinane, D.F. (2005) 'Generation of inflammatory stimuli: how bacteria set up inflammatory responses in the gingiva', *Journal of Clinical Periodontology*, 32, pp. 57-71.
- Maffei, M., Halaas, J., Ravussin, E., Pratley, R.E., Lee, G.H., Zhang, Y., Fei, H., Kim, S., Lallone, R., Ranganathan, S. and et al. (1995) 'Leptin levels in human and rodent: measurement of plasma leptin and ob RNA in obese and weight-reduced subjects', *Nat Med*, 1(11), pp. 1155-61.
- Mah, W., Jiang, G., Olver, D., Cheung, G., Kim, B., Larjava, H. and Hakkinen, L. (2014) 'Human gingival fibroblasts display a non-fibrotic phenotype distinct from skin fibroblasts in three-dimensional cultures', *PLoS One*, 9(3), p. e90715.
- Mahanonda, R., Jitprasertwong, P., Sa-Ard-Iam, N., Rerkyen, P., Charatkulangkun, O., Jansisanont, P., Nisapakultorn, K., Yongvanichit, K. and Pichyangkul, S. (2008) 'Effects of IL-17 on human gingival fibroblasts', *J Dent Res*, 87(3), pp. 267-72.
- Mahanonda, R., Sa-Ard-Iam, N., Montreekachon, P., Pimkhaokham, A., Yongvanichit, K., Fukuda, M.M. and Pichyangkul, S. (2007) 'IL-8 and IDO Expression by Human Gingival Fibroblasts via TLRs', *The Journal of Immunology*, 178(2), pp. 1151-1157.
- Makela, M., Salo, T., Uitto, V.J. and Larjava, H. (1994) 'Matrix metalloproteinases (MMP-2 and MMP-9) of the oral cavity: cellular origin and relationship to periodontal status', *J Dent Res*, 73(8), pp. 1397-406.
- Malik, V.S., Willett, W.C. and Hu, F.B. (2013) 'Global obesity: trends, risk factors and policy implications', *Nat Rev Endocrinol*, 9(1), pp. 13-27.
- Mancour, Liliya V., Daghestani, Hikmat N., Dutta, S., Westfield, Gerwin H., Schilling, J., Oleskie, Austin N., Herbstman, Jeffrey F., Chou, Steven Z. and Skiniotis, G. 'Ligand-Induced Architecture of the Leptin Receptor Signaling Complex', *Molecular Cell*, (0).
- Mancuso, P., Peters-Golden, M., Goel, D., Goldberg, J., Brock, T.G., Greenwald-Yarnell, M. and Myers, M.G. (2011) 'Disruption of Leptin Receptor-STAT3 Signaling Enhances Leukotriene Production and Pulmonary Host Defense against Pneumococcal Pneumonia', *The Journal of Immunology*, 186(2), pp. 1081-1090.
- Mantzoros, C.S., Magkos, F., Brinkoetter, M., Sienkiewicz, E., Dardeno, T.A., Kim, S.Y., Hamnvik, O.P. and Koniaris, A. (2011) 'Leptin in human physiology and pathophysiology', *Am J Physiol Endocrinol Metab*, 301(4), pp. E567-84.
- Martin-Romero, C., Santos-Alvarez, J., Goberna, R. and Sanchez-Margalet, V. (2000) 'Human leptin enhances activation and proliferation of human circulating T lymphocytes', *Cell Immunol*, 199(1), pp. 15-24.
- Matarese, G., Moschos, S. and Mantzoros, C.S. (2005) 'Leptin in Immunology', *The Journal of Immunology*, 174(6), pp. 3137-3142.
- Matarese, G., Sanna, V., Lechler, R.I., Sarvetnick, N., Fontana, S., Zappacosta, S. and La Cava, A. (2002) 'Leptin Accelerates Autoimmune Diabetes in Female NOD Mice', *Diabetes*, 51(5), pp. 1356-1361.
- Matsushita, K., Imamura, T., Tomikawa, M., Tancharoen, S., Tatsuyama, S. and Maruyama, I. (2006) 'DX-9065a inhibits proinflammatory events induced by gingipains and factor Xa', *J Periodontal Res*, 41(2), pp. 148-56.

- Mattioli, B., Giordani, L., Quaranta, M.G. and Viora, M. (2009) 'Leptin exerts an anti-apoptotic effect on human dendritic cells via the PI3K-Akt signaling pathway', *FEBS Lett*, 583(7), pp. 1102-6.
- Mazzucchelli, C., Vantaggiato, C., Ciamei, A., Fasano, S., Pakhotin, P., Krezel, W., Welzl, H., Wolfer, D.P., Pages, G., Valverde, O., Marowsky, A., Porrazzo, A., Orban, P.C., Maldonado, R., Ehrenguber, M.U., Cestari, V., Lipp, H.P., Chapman, P.F., Pouyssegur, J. and Brambilla, R. (2002) 'Knockout of ERK1 MAP kinase enhances synaptic plasticity in the striatum and facilitates striatal-mediated learning and memory', *Neuron*, 34(5), pp. 807-20.
- McCulloch, C.A. and Bordin, S. (1991) 'Role of fibroblast subpopulations in periodontal physiology and pathology', *J Periodontal Res*, 26(3 Pt 1), pp. 144-54.
- McGettrick, H.M., Buckley, C.D., Filer, A., Rainger, G.E. and Nash, G.B. (2010) 'Stromal cells differentially regulate neutrophil and lymphocyte recruitment through the endothelium', *Immunology*, 131(3), pp. 357-70.
- McGettrick, H.M., Smith, E., Filer, A., Kissane, S., Salmon, M., Buckley, C.D., Rainger, G.E. and Nash, G.B. (2009) 'Fibroblasts from different sites may promote or inhibit recruitment of flowing lymphocytes by endothelial cells', *Eur J Immunol*, 39(1), pp. 113-25.
- McInnes, I.B. and Schett, G. (2011) 'The pathogenesis of rheumatoid arthritis', *N Engl J Med*, 365(23), pp. 2205-19.
- McKleroy, W., Lee, T.H. and Atabai, K. (2013) 'Always cleave up your mess: targeting collagen degradation to treat tissue fibrosis', *Am J Physiol Lung Cell Mol Physiol*, 304(11), pp. L709-21.
- McMurtry, V., Simeone, A.M., Nieves-Alicea, R. and Tari, A.M. (2009) 'Leptin utilizes Jun N-terminal kinases to stimulate the invasion of MCF-7 breast cancer cells', *Clin Exp Metastasis*, 26(3), pp. 197-204.
- Mengshol, J.A., Mix, K.S. and Brinckerhoff, C.E. (2002) 'Matrix metalloproteinases as therapeutic targets in arthritic diseases: bull's-eye or missing the mark?', *Arthritis Rheum*, 46(1), pp. 13-20.
- Mengshol, J.A., Vincenti, M.P., Coon, C.I., Barchowsky, A. and Brinckerhoff, C.E. (2000) 'Interleukin-1 induction of collagenase 3 (matrix metalloproteinase 13) gene expression in chondrocytes requires p38, c-Jun N-terminal kinase, and nuclear factor kappaB: differential regulation of collagenase 1 and collagenase 3', *Arthritis Rheum*, 43(4), pp. 801-11.
- Mia, M.M., Boersema, M. and Bank, R.A. (2014) 'Interleukin-1 β Attenuates Myofibroblast Formation and Extracellular Matrix Production in Dermal and Lung Fibroblasts Exposed to Transforming Growth Factor- β 1', *PLoS ONE*, 9(3), p. e91559.
- Michel, O., Dentener, M., Corazza, F., Buurman, W. and Rylander, R. (2001) 'Healthy subjects express differences in clinical responses to inhaled lipopolysaccharide that are related with inflammation and with atopy', *J Allergy Clin Immunol*, 107(5), pp. 797-804.
- Mihara, M., Hashizume, M., Yoshida, H., Suzuki, M. and Shiina, M. (2012) 'IL-6/IL-6 receptor system and its role in physiological and pathological conditions', *Clin Sci (Lond)*, 122(4), pp. 143-59.
- Milner, J., Rowan, A., Cawston, T. and Young, D. (2006) 'Metalloproteinase and inhibitor expression profiling of resorbing cartilage reveals pro-collagenase activation as a critical step for collagenolysis', *Arthritis Research & Therapy*, 8(5), p. R142.
- Minami, T., Kuroishi, T., Ozawa, A., Shimauchi, H., Endo, Y. and Sugawara, S. (2007) 'Histamine Amplifies Immune Response of Gingival Fibroblasts', *Journal of Dental Research*, 86(11), pp. 1083-1088.
- Minokoshi, Y., Kim, Y.B., Peroni, O.D., Fryer, L.G., Muller, C., Carling, D. and Kahn, B.B. (2002) 'Leptin stimulates fatty-acid oxidation by activating AMP-activated protein kinase', *Nature*, 415(6869), pp. 339-43.
- Miossec, P. and Kolls, J.K. (2012) 'Targeting IL-17 and TH17 cells in chronic inflammation', *Nat Rev Drug Discov*, 11(10), pp. 763-76.
- Mita, Y., Dobashi, K., Endou, K., Kawata, T., Shimizu, Y., Nakazawa, T. and Mori, M. (2002) 'Toll-like receptor 4 surface expression on human monocytes and B cells is modulated by IL-2 and IL-4', *Immunol Lett*, 81(1), pp. 71-5.
- Montreekachon, P., Chotjumlong, P., Bolscher, J.G., Nazmi, K., Reutrakul, V. and Krisanaprakornkit, S. (2011) 'Involvement of P2X(7) purinergic receptor and MEK1/2 in

- interleukin-8 up-regulation by LL-37 in human gingival fibroblasts', *J Periodontal Res*, 46(3), pp. 327-37.
- Mor, A. and Philips, M.R. (2006) 'Compartmentalized Ras/MAPK signaling', *Annu Rev Immunol*, 24, pp. 771-800.
- Morandini, A.C., Chaves Souza, P.P., Ramos-Junior, E.S., Souza Costa, C.A. and Santos, C.F. (2012) 'MyD88 or TRAM Knockdown Regulates Interleukin (IL)-6, IL-8 and CXCL12 mRNA Expression in Human Gingival and Periodontal Ligament Fibroblasts', *J Periodontol*.
- Morandini, A.C.F., Sipert, C.R., Gasparoto, T.H., Greggi, S.L.A., Passanezi, E., Rezende, M.L.R., Sant'ana, A.P., Campanelli, A.P., Garlet, G.P. and Santos, C.F. (2009) 'Differential Production of Macrophage Inflammatory Protein-1 α , Stromal-Derived Factor-1, and IL-6 by Human Cultured Periodontal Ligament and Gingival Fibroblasts Challenged With Lipopolysaccharide From *P. gingivalis*', *Journal of Periodontology*, 81(2), pp. 310-317.
- Morgan, T.G., Rowan, A.D., Dickinson, S.C., Jones, D., Hollander, A.P., Deehan, D. and Cawston, T.E. (2006) 'Human nasal cartilage responds to oncostatin M in combination with interleukin 1 or tumour necrosis factor α by the release of collagen fragments via collagenases', *Ann Rheum Dis*, 65(2), pp. 184-190.
- Mori, T., Miyamoto, T., Yoshida, H., Asakawa, M., Kawasumi, M., Kobayashi, T., Morioka, H., Chiba, K., Toyama, Y. and Yoshimura, A. (2011) 'IL-1 β and TNF α -initiated IL-6-STAT3 pathway is critical in mediating inflammatory cytokines and RANKL expression in inflammatory arthritis', *Int Immunol*, 23(11), pp. 701-12.
- Morris, D.L. and Rui, L. (2009) 'Recent advances in understanding leptin signaling and leptin resistance', *American Journal of Physiology - Endocrinology And Metabolism*, 297(6), pp. E1247-E1259.
- Morton, C.L. and Houghton, P.J. (2007) 'Establishment of human tumor xenografts in immunodeficient mice', *Nat. Protocols*, 2(2), pp. 247-250.
- Muehlenbein, M.P., Hirschtick, J.L., Bonner, J.Z. and Swartz, A.M. (2010) 'Toward quantifying the usage costs of human immunity: Altered metabolic rates and hormone levels during acute immune activation in men', *Am J Hum Biol*, 22(4), pp. 546-56.
- Munzberg, H., Flier, J.S. and Bjorbaek, C. (2004) 'Region-specific leptin resistance within the hypothalamus of diet-induced obese mice', *Endocrinology*, 145(11), pp. 4880-9.
- Münzberg, H., Flier, J.S. and Bjørnbæk, C. (2004) 'Region-Specific Leptin Resistance within the Hypothalamus of Diet-Induced Obese Mice', *Endocrinology*, 145(11), pp. 4880-4889.
- Murakami, S., Hashikawa, T., Saho, T., Takedachi, M., Nozaki, T., Shimabukuro, Y. and Okada, H. (2001) 'Adenosine regulates the IL-1 β -induced cellular functions of human gingival fibroblasts', *Int Immunol*, 13(12), pp. 1533-40.
- Murata, M., Okuda, K., Momose, M., Kubo, K., Kuroyanagi, Y. and Wolff, L.F. (2008) 'Root coverage with cultured gingival dermal substitute composed of gingival fibroblasts and matrix: a case series', *Int J Periodontics Restorative Dent*, 28(5), pp. 461-7.
- Murphy, G. and Nagase, H. (2008) 'Progress in matrix metalloproteinase research', *Mol Aspects Med*, 29(5), pp. 290-308.
- Murphy, K., Travers, P. and Walport, M. (2011) *Janeway's Immunobiology*. 8 edn. Garland Science.
- Murray, P.J. (2007) 'The JAK-STAT signaling pathway: input and output integration', *J Immunol*, 178(5), pp. 2623-9.
- Myers, M.G., Cowley, M.A. and Munzberg, H. (2008) 'Mechanisms of leptin action and leptin resistance', *Annu Rev Physiol*, 70, pp. 537-56.
- Myers, M.G., Jr. (2010) 'Outstanding Scientific Achievement Award Lecture 2010: deconstructing leptin: from signals to circuits', *Diabetes*, 59(11), pp. 2708-14.
- Nagasawa, T., Kobayashi, H., Kiji, M., Aramaki, M., Mahanonda, R., Kojima, T., Murakami, Y., Saito, M., Morotome, Y. and Ishikawa, I. (2002) 'LPS-stimulated human gingival fibroblasts inhibit the differentiation of monocytes into osteoclasts through the production of osteoprotegerin', *Clinical & Experimental Immunology*, 130(2), pp. 338-344.
- Nagase, H., Visse, R. and Murphy, G. (2006) 'Structure and function of matrix metalloproteinases and TIMPs', *Cardiovasc Res*, 69(3), pp. 562-73.
- Najjar, I., Schischmanoff, P.O., Baran-Marszak, F., Deglesne, P.A., Youlyouz-Marfak, I., Pampin, M., Feuillard, J., Bornkamm, G.W., Chelbi-Alix, M.K. and Fagard, R. (2008) 'Novel

function of STAT1beta in B cells: induction of cell death by a mechanism different from that of STAT1alpha', *J Leukoc Biol*, 84(6), pp. 1604-12.

Nakasone, N., Kubota, T., Hoshino, C., Nohno, K., Itagaki, M., Shimizu, T. and Yoshie, H. (2009) 'Differential gene and protein expression of tissue inhibitors of metalloproteinases (TIMP)-3 and TIMP-4 in gingival tissues from drug induced gingival overgrowth', *Arch Oral Biol*, 54(7), pp. 634-41.

Nanci, A. (2013) *Ten Cate's Oral Histology: Development, Structure, and Function*. 8 edn. Elsevier Mosby.

Nanduri, B., Pendarvis, K., Shack, L.A., Kumar, R., Clymer, J.W., Korvick, D.L. and Burgess, S.C. (2013) 'Ultrasonic incisions produce less inflammatory mediator response during early healing than electrosurgical incisions', *PLoS One*, 8(9), p. e73032.

Naylor, A.J., Filer, A. and Buckley, C.D. (2012) 'The role of stromal cells in the persistence of chronic inflammation', *Clinical & Experimental Immunology*, pp. no-no.

Neumann, U., Kubota, H., Frei, K., Ganu, V. and Leppert, D. (2004) 'Characterization of Mca-Lys-Pro-Leu-Gly-Leu-Dpa-Ala-Arg-NH₂, a fluorogenic substrate with increased specificity constants for collagenases and tumor necrosis factor converting enzyme', *Analytical Biochemistry*, 328(2), pp. 166-173.

Newman, M.G., Takei, H., Klokkevold, P.R. and Carranza, F.A. (2011) *Carranza's Clinical Periodontology*. Elsevier Health Services.

Noguchi, K., Shitashige, M., Endo, H., Kondo, H. and Ishikawa, I. (2002) 'Binary regulation of interleukin (IL)-6 production by EP1 and EP2/EP4 subtypes of PGE₂ receptors in IL-1beta-stimulated human gingival fibroblasts', *J Periodontal Res*, 37(1), pp. 29-36.

Normand, J. and Karasek, M.A. (1995) 'A method for the isolation and serial propagation of keratinocytes, endothelial cells, and fibroblasts from a single punch biopsy of human skin', *In Vitro Cell Dev Biol Anim*, 31(6), pp. 447-55.

O'Kane, C.M., Elkington, P.T., Jones, M.D., Caviedes, L., Tovar, M., Gilman, R.H., Stamp, G. and Friedland, J.S. (2010) 'STAT3, p38 MAPK, and NF-kappaB drive unopposed monocyte-dependent fibroblast MMP-1 secretion in tuberculosis', *Am J Respir Cell Mol Biol*, 43(4), pp. 465-74.

Oeckinghaus, A. and Ghosh, S. (2009) 'The NF-kappaB family of transcription factors and its regulation', *Cold Spring Harb Perspect Biol*, 1(4), p. a000034.

Oh, J., Takahashi, R., Adachi, E., Kondo, S., Kuratomi, S., Noma, A., Alexander, D.B., Motoda, H., Okada, A., Seiki, M., Itoh, T., Itohara, S., Takahashi, C. and Noda, M. (2004) 'Mutations in two matrix metalloproteinase genes, MMP-2 and MT1-MMP, are synthetic lethal in mice', *Oncogene*, 23(29), pp. 5041-8.

Ohnishi, T., Okamoto, A., Kakimoto, K., Bandow, K., Chiba, N. and Matsuguchi, T. (2010) 'Involvement of Cot/Tp12 in bone loss during periodontitis', *J Dent Res*, 89(2), pp. 192-7.

Ohshima, M., Sakai, A., Ito, K. and Otsuka, K. (2002) 'Hepatocyte growth factor (HGF) in periodontal disease: detection of HGF in gingival crevicular fluid', *J Periodontal Res*, 37(1), pp. 8-14.

Organisation, W.H. (2006) *Definition and diagnosis of diabetes mellitus and intermediate hyperglycemia*.
http://www.who.int/diabetes/publications/Definition%20and%20diagnosis%20of%20diabetes_new.pdf.

Owens, B.M.J. and Simmons, A. (2013) 'Intestinal stromal cells in mucosal immunity and homeostasis', *Mucosal Immunol*, 6(2), pp. 224-234.

Ozawa, A., Tada, H., Tamai, R., Uehara, A., Watanabe, K., Yamaguchi, T., Shimauchi, H., Takada, H. and Sugawara, S. (2003) 'Expression of IL-2 receptor beta and gamma chains by human gingival fibroblasts and up-regulation of adhesion to neutrophils in response to IL-2', *J Leukoc Biol*, 74(3), pp. 352-9.

Page-McCaw, A., Ewald, A.J. and Werb, Z. (2007) 'Matrix metalloproteinases and the regulation of tissue remodelling', *Nat Rev Mol Cell Biol*, 8(3), pp. 221-33.

Pages, G. and Pouyssegur, J. (2004) 'Study of MAPK signaling using knockout mice', *Methods Mol Biol*, 250, pp. 155-66.

Palmqvist, P., Lundberg, P., Lundgren, I., Hänström, L. and Lerner, U.H. (2008) 'IL-1β and TNF-α Regulate IL-6-type Cytokines in Gingival Fibroblasts', *Journal of Dental Research*, 87(6), pp. 558-563.

- Papathanassoglou, E., El-Haschimi, K., Li, X.C., Matarese, G., Strom, T. and Mantzoros, C. (2006) 'Leptin receptor expression and signaling in lymphocytes: kinetics during lymphocyte activation, role in lymphocyte survival, and response to high fat diet in mice', *J Immunol*, 176(12), pp. 7745-52.
- Park, H., Kim, J., Cha, J., Bak, E. and Yoo, Y. (2013) 'Induction of IL-6 and IL-8 expression by leptin treatment in periodontal ligament cells and gingival fibroblasts', *International Journal of Oral Biology*, 38(2), pp. 73-80.
- Park, H.Y., Kwon, H.M., Lim, H.J., Hong, B.K., Lee, J.Y., Park, B.E., Jang, Y., Cho, S.Y. and Kim, H.S. (2001) 'Potential role of leptin in angiogenesis: leptin induces endothelial cell proliferation and expression of matrix metalloproteinases in vivo and in vitro', *Exp Mol Med*, 33(2), pp. 95-102.
- Patel, H.B. (2010) 'Animal models of rheumatoid arthritis', in *Fundamentals of Inflammation*. Cambridge University Press, pp. 406-409.
- Peelman, F., Van Beneden, K., Zabeau, L., Iserentant, H., Ulrichs, P., Defeau, D., Verhee, A., Catteeuw, D., Elewaut, D. and Tavernier, J. (2004) 'Mapping of the Leptin Binding Sites and Design of a Leptin Antagonist', *Journal of Biological Chemistry*, 279(39), pp. 41038-41046.
- Perlstein, M.I. and Bissada, N.F. (1977) 'Influence of obesity and hypertension on the severity of periodontitis in rats', *Oral Surg Oral Med Oral Pathol*, 43(5), pp. 707-19.
- Petersen, K.F., Oral, E.A., Dufour, S., Befroy, D., Ariyan, C., Yu, C., Cline, G.W., DePaoli, A.M., Taylor, S.I., Gorden, P. and Shulman, G.I. (2002) 'Leptin reverses insulin resistance and hepatic steatosis in patients with severe lipodystrophy', *J Clin Invest*, 109(10), pp. 1345-50.
- Peterson, J.T. (2006) 'The importance of estimating the therapeutic index in the development of matrix metalloproteinase inhibitors', *Cardiovasc Res*, 69(3), pp. 677-87.
- Pettigrew, D.W., Wang, H.M., Sodek, J. and Brunette, D.M. (1981) 'Synthesis of collagenolytic enzymes and their inhibitors by gingival tissue in vitro. Effect of endotoxin', *J Periodontal Res*, 16(6), pp. 637-45.
- Phipps, R.P., Borrello, M.A. and Blieden, T.M. (1997) 'Fibroblast heterogeneity in the periodontium and other tissues', *Journal of Periodontal Research*, 32(1), pp. 159-165.
- Pilling, D., Fan, T., Huang, D., Kaul, B. and Gomer, R.H. (2009) 'Identification of markers that distinguish monocyte-derived fibrocytes from monocytes, macrophages, and fibroblasts', *PLoS One*, 4(10), p. e7475.
- Pischon, N., Heng, N., Bernimoulin, J.P., Kleber, B.M., Willich, S.N. and Pischon, T. (2007) 'Obesity, inflammation, and periodontal disease', *J Dent Res*, 86(5), pp. 400-9.
- Poole, C.A. (1997) 'Articular cartilage chondrons: form, function and failure', *J Anat*, 191 (Pt 1), pp. 1-13.
- Popadiak, K., Potempa, J., Riesbeck, K. and Blom, A.M. (2007) 'Biphasic effect of gingipains from *Porphyromonas gingivalis* on the human complement system', *J Immunol*, 178(11), pp. 7242-50.
- Pozo, P., Valenzuela, M.A., Melej, C., Zaldivar, M., Puente, J., Martinez, B. and Gamonal, J. (2005) 'Longitudinal analysis of metalloproteinases, tissue inhibitors of metalloproteinases and clinical parameters in gingival crevicular fluid from periodontitis-affected patients', *J Periodontal Res*, 40(3), pp. 199-207.
- Pratap, J., Javed, A., Languino, L.R., van Wijnen, A.J., Stein, J.L., Stein, G.S. and Lian, J.B. (2005) 'The Runx2 osteogenic transcription factor regulates matrix metalloproteinase 9 in bone metastatic cancer cells and controls cell invasion', *Mol Cell Biol*, 25(19), pp. 8581-91.
- Prattes, S., Horl, G., Hammer, A., Blaschitz, A., Graier, W.F., Sattler, W., Zechner, R. and Steyrer, E. (2000) 'Intracellular distribution and mobilization of unesterified cholesterol in adipocytes: triglyceride droplets are surrounded by cholesterol-rich ER-like surface layer structures', *J Cell Sci*, 113 (Pt 17), pp. 2977-89.
- Preshaw, P.M. (2008) 'Host response modulation in periodontics', *Periodontol 2000*, 48, pp. 92-110.
- Preshaw, P.M. (2014) 'Periodontal pathogenesis', in *Carranza's Clinical Periodontology*. 12 edn. Elsevier, pp. 76-100.
- Preshaw, P.M., Alba, A.L., Herrera, D., Jepsen, S., Konstantinidis, A., Makrilakis, K. and Taylor, R. (2012) 'Periodontitis and diabetes: a two-way relationship', *Diabetologia*, 55(1), pp. 21-31.

- Preshaw, P.M., Hefti, A.F., Jepsen, S., Etienne, D., Walker, C. and Bradshaw, M.H. (2004) 'Subantimicrobial dose doxycycline as adjunctive treatment for periodontitis. A review', *J Clin Periodontol*, 31(9), pp. 697-707.
- Preshaw, P.M. and Taylor, J.J. (2011) 'How has research into cytokine interactions and their role in driving immune responses impacted our understanding of periodontitis?', *J Clin Periodontol*, 38 Suppl 11, pp. 60-84.
- Preshaw, P.M., Taylor, J.J., Jaedicke, K.M., Bissett, S.M., Stone, K., Aspiras, M., Ward, M., Souza, S., Liu, P. and Jenkins, W. (2013) 'Predictive Capability of Selected Salivary Biomarkers for Periodontal Diagnosis', *J Dent Res*, 92(Spec. Iss. A), p. 1721.
- Qi, B., Newcomer, R.G. and Sang, Q.X. (2009) 'ADAM19/adamalysin 19 structure, function, and role as a putative target in tumors and inflammatory diseases', *Curr Pharm Des*, 15(20), pp. 2336-48.
- Qi, J.H., Ebrahim, Q., Moore, N., Murphy, G., Claesson-Welsh, L., Bond, M., Baker, A. and Anand-Apte, B. (2003) 'A novel function for tissue inhibitor of metalloproteinases-3 (TIMP3): inhibition of angiogenesis by blockage of VEGF binding to VEGF receptor-2', *Nat Med*, 9(4), pp. 407-15.
- Radin, M.J., Holycross, B.J., McCune, S.A. and Altschuld, R.A. (2011) 'Crosstalk between leptin and interleukin-1beta abrogates negative inotropic effects in a model of chronic hyperleptinemia', *Exp Biol Med (Maywood)*, 236(11), pp. 1263-73.
- Raman, M., Chen, W. and Cobb, M.H. (2007) 'Differential regulation and properties of MAPKs', *Oncogene*, 26(22), pp. 3100-12.
- Ramesh, A., Thomas, B. and Gangadhar, V. (2011) 'Correlation between leptin and the health of the gingiva: A predictor of medical risk', *Indian Journal of Dental Research*, 22(4), pp. 537-541.
- Ravenhall, C., Guida, E., Harris, T., Koutsoubos, V. and Stewart, A. (2000) 'The importance of ERK activity in the regulation of cyclin D1 levels and DNA synthesis in human cultured airway smooth muscle', *Br J Pharmacol*, 131(1), pp. 17-28.
- Ren, L., Fu, Y., Deng, Y., Qi, L. and Jin, L. (2009) 'Advanced glycation end products inhibit the expression of collagens type I and III by human gingival fibroblasts', *J Periodontol*, 80(7), pp. 1166-73.
- Rojas, J.M., Oliva, J.L. and Santos, E. (2011) 'Mammalian son of sevenless Guanine nucleotide exchange factors: old concepts and new perspectives', *Genes Cancer*, 2(3), pp. 298-305.
- Rosengren, S., Firestein, G.S. and Boyle, D.L. (2003) 'Measurement of inflammatory biomarkers in synovial tissue extracts by enzyme-linked immunosorbent assay', *Clin Diagn Lab Immunol*, 10(6), pp. 1002-10.
- Roth, J.D., Roland, B.L., Cole, R.L., Trevaskis, J.L., Weyer, C., Koda, J.E., Anderson, C.M., Parkes, D.G. and Baron, A.D. (2008) 'Leptin responsiveness restored by amylin agonism in diet-induced obesity: evidence from nonclinical and clinical studies', *Proc Natl Acad Sci U S A*, 105(20), pp. 7257-62.
- Rudolph-Owen, L.A., Hulboy, D.L., Wilson, C.L., Mudgett, J. and Matrisian, L.M. (1997) 'Coordinate expression of matrix metalloproteinase family members in the uterus of normal, matrilysin-deficient, and stromelysin-1-deficient mice', *Endocrinology*, 138(11), pp. 4902-11.
- Ruwanpura, S.M., Noguchi, K. and Ishikawa, I. (2004) 'Prostaglandin E2 regulates interleukin-1beta-induced matrix metalloproteinase-3 production in human gingival fibroblasts', *J Dent Res*, 83(3), pp. 260-5.
- Sanchez-Margalet, V., Martin-Romero, C., Santos-Alvarez, J., Goberna, R., Najib, S. and Gonzalez-Yanes, C. (2003) 'Role of leptin as an immunomodulator of blood mononuclear cells: mechanisms of action', *Clin Exp Immunol*, 133(1), pp. 11-9.
- Saucillo, D.C., Gerriets, V.A., Sheng, J., Rathmell, J.C. and MacIver, N.J. (2014) 'Leptin Metabolically Licenses T Cells for Activation To Link Nutrition and Immunity', *The Journal of Immunology*, 192(1), pp. 136-144.
- Saxena, A., Chen, W., Su, Y., Rai, V., Uche, O.U., Li, N. and Frangogiannis, N.G. (2013) 'IL-1 induces proinflammatory leukocyte infiltration and regulates fibroblast phenotype in the infarcted myocardium', *J Immunol*, 191(9), pp. 4838-48.
- Saxena, N.K., Sharma, D., Ding, X., Lin, S., Marra, F., Merlin, D. and Anania, F.A. (2007) 'Concomitant activation of the JAK/STAT, PI3K/AKT, and ERK signaling is involved in leptin-

mediated promotion of invasion and migration of hepatocellular carcinoma cells', *Cancer Res*, 67(6), pp. 2497-507.

Saxena, N.K., Taliaferro-Smith, L., Knight, B.B., Merlin, D., Anania, F.A., O'Regan, R.M. and Sharma, D. (2008) 'Bidirectional crosstalk between leptin and insulin-like growth factor-I signaling promotes invasion and migration of breast cancer cells via transactivation of epidermal growth factor receptor', *Cancer Res*, 68(23), pp. 9712-22.

Schaab, M., Kausch, H., Klammt, J., Nowicki, M., Andereg, U., Gebhardt, R., Rose-John, S., Scheller, J., Thiery, J. and Kratzsch, J. (2012) 'Novel regulatory mechanisms for generation of the soluble leptin receptor: implications for leptin action', *PLoS One*, 7(4), p. e34787.

Scheller, J., Chalaris, A., Schmidt-Arras, D. and Rose-John, S. (2011) 'The pro- and anti-inflammatory properties of the cytokine interleukin-6', *Biochim Biophys Acta*, 1813(5), pp. 878-88.

Schmittgen, T.D. and Zakrajsek, B.A. (2000) 'Effect of experimental treatment on housekeeping gene expression: validation by real-time, quantitative RT-PCR', *Journal of Biochemical and Biophysical Methods*, 46(1-2), pp. 69-81.

Schram, K., De Girolamo, S., Madani, S., Munoz, D., Thong, F. and Sweeney, G. (2010) 'Leptin regulates MMP-2, TIMP-1 and collagen synthesis via p38 MAPK in HL-1 murine cardiomyocytes', *Cell Mol Biol Lett*, 15(4), pp. 551-63.

Schram, K., Ganguly, R., No, E.K., Fang, X., Thong, F.S. and Sweeney, G. (2011) 'Regulation of MT1-MMP and MMP-2 by leptin in cardiac fibroblasts involves Rho/ROCK-dependent actin cytoskeletal reorganization and leads to enhanced cell migration', *Endocrinology*, 152(5), pp. 2037-47.

Schroder, K., Hertzog, P.J., Ravasi, T. and Hume, D.A. (2004) 'Interferon-gamma: an overview of signals, mechanisms and functions', *J Leukoc Biol*, 75(2), pp. 163-89.

Schroder, K., Irvine, K.M., Taylor, M.S., Bokil, N.J., Le Cao, K.A., Masterman, K.A., Labzin, L.I., Semple, C.A., Kapetanovic, R., Fairbairn, L., Akalin, A., Faulkner, G.J., Baillie, J.K., Gongora, M., Daub, C.O., Kawaji, H., McLachlan, G.J., Goldman, N., Grimmond, S.M., Carninci, P., Suzuki, H., Hayashizaki, Y., Lenhard, B., Hume, D.A. and Sweet, M.J. (2012) 'Conservation and divergence in Toll-like receptor 4-regulated gene expression in primary human versus mouse macrophages', *Proc Natl Acad Sci U S A*, 109(16), pp. E944-53.

Schulz, L.C., Widmaier, E.P., Qiu, J. and Roberts, R.M. (2009) 'Effect of leptin on mouse trophoblast giant cells', *Biol Reprod*, 80(3), pp. 415-24.

Scott, D.A. and Krauss, J. (2012) 'Neutrophils in periodontal inflammation', *Front Oral Biol*, 15, pp. 56-83.

Scragg, M.A., Cannon, S.J., Rangarajan, M., Williams, D.M. and Curtis, M.A. (1999) 'Targeted disruption of fibronectin-integrin interactions in human gingival fibroblasts by the RI protease of *Porphyromonas gingivalis* W50', *Infect Immun*, 67(4), pp. 1837-43.

Seguier, S., Gogly, B., Bodineau, A., Godeau, G. and Brousse, N. (2001) 'Is collagen breakdown during periodontitis linked to inflammatory cells and expression of matrix metalloproteinases and tissue inhibitors of metalloproteinases in human gingival tissue?', *J Periodontol*, 72(10), pp. 1398-406.

Seguin-Estevez, Q., De Palma, R., Krawczyk, M., Leimgruber, E., Villard, J., Picard, C., Tagliamacco, A., Abbate, G., Gorski, J., Nocera, A. and Reith, W. (2009) 'The transcription factor RFX protects MHC class II genes against epigenetic silencing by DNA methylation', *J Immunol*, 183(4), pp. 2545-53.

Sempowski, G.D., Chess, P.R., Moretti, A.J., Padilla, J., Phipps, R.P. and Blieden, T.M. (1997) 'CD40 mediated activation of gingival and periodontal ligament fibroblasts', *J Periodontol*, 68(3), pp. 284-92.

Seok, J., Warren, H.S., Cuenca, A.G., Mindrinos, M.N., Baker, H.V., Xu, W., Richards, D.R., McDonald-Smith, G.P., Gao, H., Hennessy, L., Finnerty, C.C., Lopez, C.M., Honari, S., Moore, E.E., Minei, J.P., Cuschieri, J., Bankey, P.E., Johnson, J.L., Sperry, J., Nathens, A.B., Billiar, T.R., West, M.A., Jeschke, M.G., Klein, M.B., Gamelli, R.L., Gibran, N.S., Brownstein, B.H., Miller-Graziano, C., Calvano, S.E., Mason, P.H., Cobb, J.P., Rahme, L.G., Lowry, S.F., Maier, R.V., Moldawer, L.L., Herndon, D.N., Davis, R.W., Xiao, W., Tompkins, R.G., Inflammation and Host Response to Injury, L.S.C.R.P. (2013) 'Genomic responses in mouse models poorly mimic human inflammatory diseases', *Proc Natl Acad Sci U S A*, 110(9), pp. 3507-12.

- Serhan, C.N., Jain, A., Marleau, S., Clish, C., Kantarci, A., Behbehani, B., Colgan, S.P., Stahl, G.L., Merched, A., Petasis, N.A., Chan, L. and Van Dyke, T.E. (2003) 'Reduced inflammation and tissue damage in transgenic rabbits overexpressing 15-lipoxygenase and endogenous anti-inflammatory lipid mediators', *J Immunol*, 171(12), pp. 6856-65.
- Shan, J., Nguyen, T.B., Totary-Jain, H., Dansky, H., Marx, S.O. and Marks, A.R. (2008) 'Leptin-enhanced neointimal hyperplasia is reduced by mTOR and PI3K inhibitors', *Proc Natl Acad Sci U S A*, 105(48), pp. 19006-11.
- Shen, J., Sakaida, I., Uchida, K., Terai, S. and Okita, K. (2005) 'Leptin enhances TNF-alpha production via p38 and JNK MAPK in LPS-stimulated Kupffer cells', *Life Sci*, 77(13), pp. 1502-15.
- Sheth, R.A., Kunin, A., Stangenberg, L., Sinnamon, M., Hung, K.E., Kucherlapati, R. and Mahmood, U. (2012) 'In vivo optical molecular imaging of matrix metalloproteinase activity following celecoxib therapy for colorectal cancer', *Mol Imaging*, 11(5), pp. 417-25.
- Shi, M., Lin, T.H., Appell, K.C. and Berg, L.J. (2008) 'Janus-kinase-3-dependent signals induce chromatin remodeling at the Ifng locus during T helper 1 cell differentiation', *Immunity*, 28(6), pp. 763-73.
- Shikata, H., Utsumi, N., Shimojima, T., Oda, Y. and Okada, Y. (1993) 'Increased expression of type VI collagen genes in drug-induced gingival enlargement', *FEBS Lett*, 334(1), pp. 65-8.
- Shimada, Y., Komatsu, Y., Ikezawa-Suzuki, I., Tai, H., Sugita, N. and Yoshie, H. (2010) 'The effect of periodontal treatment on serum leptin, interleukin-6, and C-reactive protein', *J Periodontol*, 81(8), pp. 1118-23.
- Shpilman, M., Niv-Spector, L., Katz, M., Varol, C., Solomon, G., Ayalon-Soffer, M., Boder, E., Halpern, Z., Elinav, E. and Gertler, A. (2011) 'Development and Characterization of High Affinity Leptins and Leptin Antagonists', *Journal of Biological Chemistry*, 286(6), pp. 4429-4442.
- Sierra-Honigsmann, M.R.o., Nath, A.K., Murakami, C., García-Cardena, G., Papapetropoulos, A., Sessa, W.C., Madge, L.A., Schechner, J.S., Schwabb, M.B., Polverini, P.J. and Flores-Riveros, J.R. (1998) 'Biological Action of Leptin as an Angiogenic Factor', *Science*, 281(5383), pp. 1683-1686.
- Silva, T.A., Garlet, G.P., Fukada, S.Y., Silva, J.S. and Cunha, F.Q. (2007) 'Chemokines in oral inflammatory diseases: apical periodontitis and periodontal disease', *J Dent Res*, 86(4), pp. 306-19.
- Singh, R., Wang, Y., Xiang, Y., Tanaka, K.E., Gaarde, W.A. and Czaja, M.J. (2009) 'Differential effects of JNK1 and JNK2 inhibition on murine steatohepatitis and insulin resistance', *Hepatology*, 49(1), pp. 87-96.
- Slots, J. (2005) 'Herpesviruses in periodontal diseases', *Periodontol 2000*, 38, pp. 33-62.
- Smith, P.C., Guerrero, J., Tobar, N., Cáceres, M., González, M.J. and Martínez, J. (2009) 'Tumor necrosis factor- α -stimulated membrane type 1-matrix metalloproteinase production is modulated by epidermal growth factor receptor signaling in human gingival fibroblasts', *Journal of Periodontal Research*, 44(1), pp. 73-80.
- Smyth, E.M., Grosser, T., Wang, M., Yu, Y. and FitzGerald, G.A. (2009) 'Prostanoids in health and disease', *J Lipid Res*, 50 Suppl, pp. S423-8.
- Soboku, K., Kikuchi, T., Fujita, S., Takeda, H., Naruse, K., Matsubara, T. and Noguchi, T. (2014) 'Altered gene expression in gingival tissues and enhanced bone loss in rats with diabetes with experimental periodontitis', *J Periodontol*, 85(3), pp. 455-64.
- Socransky, S.S. (1979) 'Criteria for the infectious agents in dental caries and periodontal disease', *J Clin Periodontol*, 6(7), pp. 16-21.
- Sodin-Semrl, S., Taddeo, B., Tseng, D., Varga, J. and Fiore, S. (2000) 'Lipoxin A4 inhibits IL-1 beta-induced IL-6, IL-8, and matrix metalloproteinase-3 production in human synovial fibroblasts and enhances synthesis of tissue inhibitors of metalloproteinases', *J Immunol*, 164(5), pp. 2660-6.
- Soell, M., Elkaim, R. and Tenenbaum, H. (2002) 'Cathepsin C, matrix metalloproteinases, and their tissue inhibitors in gingiva and gingival crevicular fluid from periodontitis-affected patients', *J Dent Res*, 81(3), pp. 174-8.
- Sorrell, J.M., Baber, M.A. and Caplan, A.I. (2008) 'Human dermal fibroblast subpopulations; differential interactions with vascular endothelial cells in coculture: nonsoluble factors in the extracellular matrix influence interactions', *Wound Repair Regen*, 16(2), pp. 300-9.

- Sorsa, T., Tjaderhane, L., Konttinen, Y.T., Lauhio, A., Salo, T., Lee, H.M., Golub, L.M., Brown, D.L. and Mantyla, P. (2006) 'Matrix metalloproteinases: contribution to pathogenesis, diagnosis and treatment of periodontal inflammation', *Ann Med*, 38(5), pp. 306-21.
- Souza, P.P., Palmqvist, P., Lundgren, I., Lie, A., Costa-Neto, C.M., Lundberg, P. and Lerner, U.H. (2010) 'Stimulation of IL-6 cytokines in fibroblasts by toll-like receptors 2', *J Dent Res*, 89(8), pp. 802-7.
- Staunton, D., Hudson, K.R. and Heath, J.K. (1998) 'The interactions of the cytokine-binding homology region and immunoglobulin-like domains of gp130 with oncostatin M: implications for receptor complex formation', *Protein Eng*, 11(11), pp. 1093-102.
- Steinberg, G.R., Parolin, M.L., Heigenhauser, G.J. and Dyck, D.J. (2002) 'Leptin increases FA oxidation in lean but not obese human skeletal muscle: evidence of peripheral leptin resistance', *Am J Physiol Endocrinol Metab*, 283(1), pp. E187-92.
- Stekel, D. (2003) *Microarray Bioinformatics*. Cambridge University Press.
- Stickens, D., Behonick, D.J., Ortega, N., Heyer, B., Hartenstein, B., Yu, Y., Fosang, A.J., Schorpp-Kistner, M., Angel, P. and Werb, Z. (2004) 'Altered endochondral bone development in matrix metalloproteinase 13-deficient mice', *Development*, 131(23), pp. 5883-95.
- Stuelten, C.H., DaCosta Byfield, S., Arany, P.R., Karpova, T.S., Stetler-Stevenson, W.G. and Roberts, A.B. (2005) 'Breast cancer cells induce stromal fibroblasts to express MMP-9 via secretion of TNF-alpha and TGF-beta', *J Cell Sci*, 118(Pt 10), pp. 2143-53.
- Sukhotnik, I., Coran, A.G., Mogilner, J.G., Shamian, B., Karry, R., Lieber, M. and Shaoul, R. (2009) 'Leptin affects intestinal epithelial cell turnover in correlation with leptin receptor expression along the villus-crypt axis after massive small bowel resection in a rat', *Pediatr Res*, 66(6), pp. 648-53.
- Sukkar, T.Z., Thomason, J.M., Cawston, T.E., Lakey, R., Jones, D., Catterall, J. and Seymour, R.A. (2007) 'Gingival fibroblasts grown from cyclosporin-treated patients show a reduced production of matrix metalloproteinase-1 (MMP-1) compared with normal gingival fibroblasts, and cyclosporin down-regulates the production of MMP-1 stimulated by pro-inflammatory cytokines', *J Periodontal Res*, 42(6), pp. 580-8.
- Sume, S.S., Kantarci, A., Lee, A., Hasturk, H. and Trackman, P.C. (2010) 'Epithelial to mesenchymal transition in gingival overgrowth', *Am J Pathol*, 177(1), pp. 208-18.
- Sun, X., Mao, Y., Wang, J., Zu, L., Hao, M., Cheng, G., Qu, Q., Cui, D., Keller, E.T., Chen, X., Shen, K. and Wang, J. (2014) 'IL-6 secreted by cancer-associated fibroblasts induces tamoxifen resistance in luminal breast cancer', *Oncogene*, 33(35), p. 4450.
- Suvan, J., D'Aiuto, F., Moles, D.R., Petrie, A. and Donos, N. (2011) 'Association between overweight/obesity and periodontitis in adults. A systematic review', *Obes Rev*, 12(5), pp. e381-404.
- Suvan, J., Petrie, A., Moles, D.R., Nibali, L., Patel, K., Darbar, U., Donos, N., Tonetti, M. and D'Aiuto, F. (2014) 'Body Mass Index as a Predictive Factor of Periodontal Therapy Outcomes', *Journal of Dental Research*, 93(1), pp. 49-54.
- Szpaderska, A.M., Zuckerman, J.D. and DiPietro, L.A. (2003) 'Differential injury responses in oral mucosal and cutaneous wounds', *J Dent Res*, 82(8), pp. 621-6.
- Taga, T. and Kishimoto, T. (1997a) 'Gp130 and the interleukin-6 family of cytokines', *Annu Rev Immunol*, 15, pp. 797-819.
- Taga, T. and Kishimoto, T. (1997b) 'gp130 AND THE INTERLEUKIN-6 FAMILY OF CYTOKINES', *Annual Review of Immunology*, 15(1), pp. 797-819.
- Tagoe, C.E., Marjanovic, N., Park, J.Y., Chan, E.S., Abeles, A.M., Attur, M., Abramson, S.B. and Pillinger, M.H. (2008) 'Annexin-1 mediates TNF-alpha-stimulated matrix metalloproteinase secretion from rheumatoid arthritis synovial fibroblasts', *J Immunol*, 181(4), pp. 2813-20.
- Takahashi, N., Kobayashi, M., Takaki, T., Takano, K., Miyata, M., Okamatsu, Y., Hasegawa, K., Nishihara, T. and Yamamoto, M. (2008) 'Actinobacillus actinomycetemcomitans lipopolysaccharide stimulates collagen phagocytosis by human gingival fibroblasts', *Oral Microbiology and Immunology*, 23(3), pp. 259-264.
- Takashiba, S., Naruishi, K. and Murayama, Y. (2003) 'Perspective of cytokine regulation for periodontal treatment: fibroblast biology', *J Periodontol*, 74(1), pp. 103-10.
- Tandara, A.A. and Mustoe, T.A. (2011) 'MMP- and TIMP-secretion by human cutaneous keratinocytes and fibroblasts - Impact of coculture and hydration', *Journal of Plastic, Reconstructive and Aesthetic Surgery*, 64(1), pp. 108-116.

Tardif, F., Ross, G. and Rouabhia, M. (2004) 'Gingival and dermal fibroblasts produce interleukin-1 beta converting enzyme and interleukin-1 beta but not interleukin-18 even after stimulation with lipopolysaccharide', *J Cell Physiol*, 198(1), pp. 125-32.

Tartaglia, L.A. (1997) 'The leptin receptor', *J Biol Chem*, 272(10), pp. 6093-6.

Tartaglia, L.A., Dembski, M., Weng, X., Deng, N., Culpepper, J., Devos, R., Richards, G.J., Campfield, L.A., Clark, F.T., Deeds, J., Muir, C., Sanker, S., Moriarty, A., Moore, K.J., Smutko, J.S., Mays, G.G., Wool, E.A., Monroe, C.A. and Tepper, R.I. (1995) 'Identification and expression cloning of a leptin receptor, OB-R', *Cell*, 83(7), pp. 1263-1271.

Taubman, M.A., Kawai, T. and Han, X. (2007) 'The new concept of periodontal disease pathogenesis requires new and novel therapeutic strategies', *J Clin Periodontol*, 34(5), pp. 367-9.

Taylor, J.J., Preshaw, P.M. and Donaldson, P.T. (2004) 'Cytokine gene polymorphism and immunoregulation in periodontal disease', *Periodontol 2000*, 35, pp. 158-82.

Taylor, J.J., Preshaw, P.M. and Lalla, E. (2013) 'A review of the evidence for pathogenic mechanisms that may link periodontitis and diabetes', *J Periodontol*, 84(4 Suppl), pp. S113-34.

Teles, R.P., Likhari, V., Socransky, S.S. and Haffajee, A.D. (2009) 'Salivary cytokine levels in subjects with chronic periodontitis and in periodontally healthy individuals: a cross-sectional study', *Journal of Periodontal Research*, 44(3), pp. 411-417.

Tervahartiala, T., Pirila, E., Ceponis, A., Maisi, P., Salo, T., Tuter, G., Kallio, P., Tornwall, J., Srinivas, R., Konttinen, Y.T. and Sorsa, T. (2000) 'The in vivo expression of the collagenolytic matrix metalloproteinases (MMP-2, -8, -13, and -14) and matrilysin (MMP-7) in adult and localized juvenile periodontitis', *J Dent Res*, 79(12), pp. 1969-77.

Tessier, D.R., Ferraro, Z.M. and Gruslin, A. (2013) 'Role of leptin in pregnancy: consequences of maternal obesity', *Placenta*, 34(3), pp. 205-11.

Thorek, D.L., Ogirala, A., Beattie, B.J. and Grimm, J. (2013) 'Quantitative imaging of disease signatures through radioactive decay signal conversion', *Nat Med*, 19(10), pp. 1345-50.

Tipton, D.A., Stricklin, G.P. and Dabbous, M.K. (1991) 'Fibroblast heterogeneity in collagenolytic response to cyclosporine', *J Cell Biochem*, 46(2), pp. 152-65.

Tong, K.M., Shieh, D.C., Chen, C.P., Tzeng, C.Y., Wang, S.P., Huang, K.C., Chiu, Y.C., Fong, Y.C. and Tang, C.H. (2008) 'Leptin induces IL-8 expression via leptin receptor, IRS-1, PI3K, Akt cascade and promotion of NF-kappaB/p300 binding in human synovial fibroblasts', *Cell Signal*, 20(8), pp. 1478-88.

Toshchakov, V.U., Basu, S., Fenton, M.J. and Vogel, S.N. (2005) 'Differential involvement of BB loops of toll-IL-1 resistance (TIR) domain-containing adapter proteins in TLR4- versus TLR2-mediated signal transduction', *J Immunol*, 175(1), pp. 494-500.

Trombone, A.P.F., Ferreira Jr, S.B., Raimundo, F.M., De Moura, K.C.R., Avila-Campos, M.J., Silva, J.S., Campanelli, A.P., De Franco, M. and Garlet, G.P. (2009) 'Experimental periodontitis in mice selected for maximal or minimal inflammatory reactions: increased inflammatory immune responsiveness drives increased alveolar bone loss without enhancing the control of periodontal infection', *Journal of Periodontal Research*, 44(4), pp. 443-451.

Uddin, S., Bu, R., Ahmed, M., Hussain, A.R., Ajarim, D., Al-Dayel, F., Bavi, P. and Al-kuraya, K.S. (2010) 'Leptin receptor expression and its association with PI3K/AKT signaling pathway in diffuse large B-cell lymphoma', *Leukemia & Lymphoma*, 51(7), pp. 1305-1314.

Uehara, A., Muramoto, K., Imamura, T., Nakayama, K., Potempa, J., Travis, J., Sugawara, S. and Takada, H. (2005) 'Arginine-Specific Gingipains from *Porphyromonas gingivalis* Stimulate Production of Hepatocyte Growth Factor (Scatter Factor) through Protease-Activated Receptors in Human Gingival Fibroblasts in Culture', *The Journal of Immunology*, 175(9), pp. 6076-6084.

Uehara, A. and Takada, H. (2007) 'Functional TLRs and NODs in human gingival fibroblasts', *J Dent Res*, 86(3), pp. 249-54.

Uhlir, H.H. and Powrie, F. (2009) 'Mouse models of intestinal inflammation as tools to understand the pathogenesis of inflammatory bowel disease', *Eur J Immunol*, 39(8), pp. 2021-6.

Uitto, V.J., Overall, C.M. and McCulloch, C. (2003) 'Proteolytic host cell enzymes in gingival crevice fluid', *Periodontol 2000*, 31, pp. 77-104.

Ujii, Y., Goda, S. and Matsumoto, N. (2012) 'Effect of p38 MAP kinase on the production of MMP-1 in human gingival fibroblast-like cells', *Orthodontic Waves*, 71(1), pp. 26-30.

Um, S., Choi, J.R., Lee, J.H., Zhang, Q. and Seo, B.M. (2011) 'Effect of leptin on differentiation of human dental stem cells', *Oral Diseases*, 17(7), pp. 662-669.

- Umeki, H., Tokuyama, R., Ide, S., Okubo, M., Tadokoro, S., Tezuka, M., Tatehara, S. and Satomura, K. (2014) 'Leptin promotes wound healing in the oral mucosa', *PLoS One*, 9(7), p. e101984.
- Valerio, A., Dossena, M., Bertolotti, P., Boroni, F., Sarnico, I., Faraco, G., Chiarugi, A., Frontini, A., Giordano, A., Liou, H.C., De Simoni, M.G., Spano, P., Carruba, M.O., Pizzi, M. and Nisoli, E. (2009) 'Leptin is induced in the ischemic cerebral cortex and exerts neuroprotection through NF-kappaB/c-Rel-dependent transcription', *Stroke*, 40(2), pp. 610-7.
- Van Dyke, T.E. and Serhan, C.N. (2003) 'Resolution of inflammation: a new paradigm for the pathogenesis of periodontal diseases', *J Dent Res*, 82(2), pp. 82-90.
- Vantaggiato, C., Formentini, I., Bondanza, A., Bonini, C., Naldini, L. and Brambilla, R. (2006) 'ERK1 and ERK2 mitogen-activated protein kinases affect Ras-dependent cell signaling differentially', *J Biol*, 5(5), p. 14.
- Varani, J. (2010) 'Fibroblast aging: intrinsic and extrinsic factors', *Drug Discovery Today: Therapeutic Strategies*, 7(3-4), pp. 65-70.
- Vardar-Sengul, S., Arora, S., Baylas, H. and Mercola, D. (2009) 'Expression Profile of Human Gingival Fibroblasts Induced by Interleukin-1 β Reveals Central Role of Nuclear Factor-Kappa B in Stabilizing Human Gingival Fibroblasts During Inflammation', *Journal of Periodontology*, 80(5), pp. 833-849.
- Vardar-Sengul, S., Buduneli, E., Turkoglu, O., Buduneli, N., Atilla, G., Wahlgren, J., Sorsa, T. and Baylas, H. (2008) 'The effects of selective COX-2 inhibitor/celecoxib and omega-3 fatty acid on matrix metalloproteinases, TIMP-1, and laminin-5gamma2-chain immunolocalization in experimental periodontitis', *J Periodontol*, 79(10), pp. 1934-41.
- Velazquez, O.C., Snyder, R., Liu, Z.J., Fairman, R.M. and Herlyn, M. (2002) 'Fibroblast-dependent differentiation of human microvascular endothelial cells into capillary-like 3-dimensional networks', *FASEB J*, 16(10), pp. 1316-8.
- Vernooy, J.H., Bracke, K.R., Drummen, N.E., Pauwels, N.S., Zabeau, L., van Suylen, R.J., Tavernier, J., Joos, G.F., Wouters, E.F. and Brusselle, G.G. (2010) 'Leptin modulates innate and adaptive immune cell recruitment after cigarette smoke exposure in mice', *J Immunol*, 184(12), pp. 7169-77.
- Vincenti, M.P. (2001) 'The matrix metalloproteinase (MMP) and tissue inhibitor of metalloproteinase (TIMP) genes. Transcriptional and posttranscriptional regulation, signal transduction and cell-type-specific expression', *Methods Mol Biol*, 151, pp. 121-48.
- Vincenti, M.P. and Brinckerhoff, C.E. (2002) 'Transcriptional regulation of collagenase (MMP-1, MMP-13) genes in arthritis: integration of complex signaling pathways for the recruitment of gene-specific transcription factors', *Arthritis Res*, 4(3), pp. 157-64.
- Vitkov, L., Klappacher, M., Hannig, M. and Krautgartner, W.D. (2009) 'Extracellular neutrophil traps in periodontitis', *J Periodontal Res*, 44(5), pp. 664-72.
- Wang, M. and Liang, P. (2005) 'Interleukin-24 and its receptors', *Immunology*, 114(2), pp. 166-70.
- Wang, P.L. and Ohura, K. (2002) 'Porphyromonas gingivalis lipopolysaccharide signaling in gingival fibroblasts-CD14 and Toll-like receptors', *Crit Rev Oral Biol Med*, 13(2), pp. 132-42.
- Wassenaar, A., Verschoor, T., Kievits, F., Den Hartog, M.T., Kapsenberg, M.L., Everts, V. and Snijders, A. (1999) 'CD40 engagement modulates the production of matrix metalloproteinases by gingival fibroblasts', *Clin Exp Immunol*, 115(1), pp. 161-7.
- Weinberg, E., Zeldich, E., Weinreb, M.M., Moses, O., Nemcovsky, C. and Weinreb, M. (2009) 'Prostaglandin E2 inhibits the proliferation of human gingival fibroblasts via the EP2 receptor and Epac', *Journal of Cellular Biochemistry*, 108(1), pp. 207-215.
- White, D., Pitts, N., Steele, J., Sadler, K. and Chadwick, B. (2011) *Disease and related disorders – a report from the Adult Dental Health Survey 2009*. Centre, T.H.a.S.C.I. [Online]. Available at: <http://www.hscic.gov.uk/catalogue/PUB01086/adul-dent-heal-surv-summ-them-the2-2009-rep4.pdf> (Accessed: 21/7/14).
- Wikesjö, U.M.E. and Selvig, K.A. (1999) 'Periodontal wound healing and regeneration', *Periodontology 2000*, 19(1), pp. 21-39.
- Williams, K.W., Margatho, L.O., Lee, C.E., Choi, M., Lee, S., Scott, M.M., Elias, C.F. and Elmquist, J.K. (2010) 'Segregation of acute leptin and insulin effects in distinct populations of arcuate proopiomelanocortin neurons', *J Neurosci*, 30(7), pp. 2472-9.

- Wisler, B.A., Dennis, J.E. and Malemud, C.J. (2011) 'New organ-specific pharmacological strategies interfering with signaling pathways in inflammatory disorders/autoimmune disorders', *Current Signal Transduction Therapy*, 6(2), pp. 279-291.
- Wurfel, M.M., Park, W.Y., Radella, F., Ruzinski, J., Sandstrom, A., Strout, J., Bumgarner, R.E. and Martin, T.R. (2005) 'Identification of high and low responders to lipopolysaccharide in normal subjects: an unbiased approach to identify modulators of innate immunity', *J Immunol*, 175(4), pp. 2570-8.
- Wythe, S.E., DiCara, D., Taher, T.E., Finucane, C.M., Jones, R., Bombardieri, M., Man, Y.K., Nissim, A., Mather, S.J., Chernajovsky, Y. and Pitzalis, C. (2013) 'Targeted delivery of cytokine therapy to rheumatoid tissue by a synovial targeting peptide', *Ann Rheum Dis*, 72(1), pp. 129-35.
- Xiang, J., Li, C., Dong, W., Cao, Z. and Liu, L. (2009) 'Expression of matrix metalloproteinase-1, matrix metalloproteinase-2 and extracellular metalloproteinase inducer in human periodontal ligament cells stimulated with interleukin-1 beta', *J Periodontol Res*, 44(6), pp. 784-93.
- Xiao, Y., Bunn, C.L. and Bartold, P.M. (2001) 'Effect of lipopolysaccharide from periodontal pathogens on the production of tissue plasminogen activator and plasminogen activator inhibitor 2 by human gingival fibroblasts', *J Periodontol Res*, 36(1), pp. 25-31.
- Xu, J., Rodriguez, D., Petittler, E., Kim, J.J., Hangai, M., Moon, Y.S., Davis, G.E. and Brooks, P.C. (2001) 'Proteolytic exposure of a cryptic site within collagen type IV is required for angiogenesis and tumor growth in vivo', *J Cell Biol*, 154(5), pp. 1069-79.
- Yamada, H., Nishimura, F., Naruishi, K., Chou, H.-H., Takashiba, S., Albright, G.M., Nares, S., Iacopino, A.M. and Murayama, Y. (2000) 'Phenytoin and Cyclosporin A Suppress the Expression of MMP-1, TIMP-1, and Cathepsin L, But Not Cathepsin B in Cultured Gingival Fibroblasts', *Journal of Periodontology*, 71(6), pp. 955-960.
- Yao, Y., Li, W., Wu, J., Germann, U.A., Su, M.S., Kuida, K. and Boucher, D.M. (2003) 'Extracellular signal-regulated kinase 2 is necessary for mesoderm differentiation', *Proc Natl Acad Sci U S A*, 100(22), pp. 12759-64.
- Yeh, W.L., Lu, D.Y., Lee, M.J. and Fu, W.M. (2009) 'Leptin induces migration and invasion of glioma cells through MMP-13 production', *Glia*, 57(4), pp. 454-64.
- Yetkin Ay, Z., Kirzioglu, F.Y., Ozturk Tonguc, M., Sutcu, R. and Kapucuoglu, N. (2011) 'The gingiva contains leptin and leptin receptor in health and disease', *Odontology*.
- Yordy, J.S. and Muise-Helmericks, R.C. (2000) 'Signal transduction and the Ets family of transcription factors', *Oncogene*, 19(55), pp. 6503-13.
- Yoshioka, H., Yoshimura, A., Kaneko, T., Golenbock, D.T. and Hara, Y. (2008) 'Analysis of the activity to induce toll-like receptor (TLR)2- and TLR4-mediated stimulation of supragingival plaque', *J Periodontol*, 79(5), pp. 920-8.
- Yu, S., Li, H., Ma, Y. and Fu, Y. (2012) 'Matrix metalloproteinase-1 of gingival fibroblasts influenced by advanced glycation end products (AGEs) and their association with receptor for AGEs and nuclear factor-kappaB in gingival connective tissue', *J Periodontol*, 83(1), pp. 119-26.
- Yuan, J.S., Reed, A., Chen, F. and Stewart, C.N., Jr. (2006) 'Statistical analysis of real-time PCR data', *BMC Bioinformatics*, 7, p. 85.
- Yucel-Lindberg, T. and Brunius, G. (2006) 'Epidermal growth factor synergistically enhances interleukin-8 production in human gingival fibroblasts stimulated with interleukin-1beta', *Arch Oral Biol*, 51(10), pp. 892-8.
- Yucel-Lindberg, T., Brunius, G., Wondimu, B., Anduren, I. and Modeer, T. (2001) 'Enhanced cyclooxygenase-2 mRNA expression in human gingival fibroblasts induced by cell contact with human lymphocytes', *Eur J Oral Sci*, 109(3), pp. 187-92.
- Zarkesh-Esfahani, H., Pockley, A.G., Wu, Z., Hellewell, P.G., Weetman, A.P. and Ross, R.J. (2004) 'Leptin indirectly activates human neutrophils via induction of TNF-alpha', *J Immunol*, 172(3), pp. 1809-14.
- Zarkesh-Esfahani, H., Pockley, G., Metcalfe, R.A., Bidlingmaier, M., Wu, Z., Ajami, A., Weetman, A.P., Strasburger, C.J. and Ross, R.J. (2001) 'High-dose leptin activates human leukocytes via receptor expression on monocytes', *J Immunol*, 167(8), pp. 4593-9.
- Zhang, W., Fang, M., Song, F. and Windsor, L.J. (2011) 'Effects of cigarette smoke condensate and nicotine on human gingival fibroblast-mediated collagen degradation', *J Periodontol*, 82(7), pp. 1071-9.

- Zhang, W., Song, F. and Windsor, L.J. (2010) 'Effects of tobacco and *P. gingivalis* on gingival fibroblasts', *J Dent Res*, 89(5), pp. 527-31.
- Zhang, Y., Proenca, R., Maffei, M., Barone, M., Leopold, L. and Friedman, J.M. (1994) 'Positional cloning of the mouse obese gene and its human homologue', *Nature*, 372(6505), pp. 425-32.
- Zhou, J., Olson, B.L. and Windsor, L.J. (2007) 'Nicotine increases the collagen-degrading ability of human gingival fibroblasts', *Journal of Periodontal Research*, 42(3), pp. 228-235.
- Zhou, J. and Windsor, L.J. (2006) 'Porphyromonas gingivalis affects host collagen degradation by affecting expression, activation, and inhibition of matrix metalloproteinases', *J Periodontal Res*, 41(1), pp. 47-54.
- Zhou, W., Guo, S. and Gonzalez-Perez, R.R. (2011) 'Leptin pro-angiogenic signature in breast cancer is linked to IL-1 signalling', *Br J Cancer*, 104(1), pp. 128-137.
- Zhu, L., Wu, Y., Wei, H., Xing, X., Zhan, N., Xiong, H. and Peng, B. (2011) 'IL-17R activation of human periodontal ligament fibroblasts induces IL-23 p19 production: Differential involvement of NF- κ B versus JNK/AP-1 pathways', *Molecular Immunology*, 48(4), pp. 647-656.
- Zijngel, V., van Leeuwen, M.B., Degener, J.E., Abbas, F., Thurnheer, T., Gmur, R. and Harmsen, H.J. (2010) 'Oral biofilm architecture on natural teeth', *PLoS One*, 5(2), p. e9321.
- Zimmermann, G.S., Bastos, M.F., Dias Goncalves, T.E., Chambrone, L. and Duarte, P.M. (2013) 'Local and circulating levels of adipocytokines in obese and normal weight individuals with chronic periodontitis', *J Periodontol*, 84(5), pp. 624-33.
- Zizzi, A., Tirabassi, G., Aspriello, S.D., Piemontese, M., Rubini, C. and Lucarini, G. (2012) 'Gingival advanced glycation end-products in diabetes mellitus-associated chronic periodontitis: an immunohistochemical study', *J Periodontal Res*.