

**Newcastle**  
University

School of Engineering

Improving Feeder Automation for  
Medium Voltage Distribution Networks

A thesis presented for the degree of  
Doctor of Philosophy

March 2022

**John Caruana**

B.Eng. (Hons) Electrical, University of Malta  
MSc. Power Distribution Engineering, University of Manchester



## ABSTRACT

Distribution Network Automation is being introduced by Distribution System Operators (DSOs) as part of the Smart Grid implementation. Present HV and MV networks are being extended and modified so that they will be able to meet the increase in electrical demand and the changes to the Power Generation Sector. Past analysis showed that during peak demand periods, many components of the MV network are operated close to their maximum capacity and with no redundancy. This means that in the short-term, significant parts of the network will be unable to meet the peak demand in case of a failure of one of the main components. Furthermore, significant parts of the network will be unable to meet the expected increase in demand in the long-term should load growth increases significantly.

Although there have been many academic studies on designing automation schemes, they are often approached from a theoretical optimisation viewpoint. However, it is essential to approach this from an operations engineering perspective because a real network provides daily operational restrictions to a DSO, although these are not always visible from outside the DSO organisation. Nevertheless, this does have a direct impact on the quality of supply given to the DSO customers.

The research objective is to obtain an optimisation method and determine the most appropriate MV substation locations, where automation technology can be installed, as a function of network operations restrictions. The research analysed a Maltese 11kV network, which is like DSO networks in UK. Hence what was achieved from this research is also adaptable to UK networks.

Customer minutes lost and energy not supplied were achieved by considering MV restrictions that exist in networks substation location, substation access and switchgear operational restrictions. All these have been factored in the optimisation process to select the optimum locations where existing substations could be automated. The optimisation process included the actual automation cost for the existing switchgear in the selected substations. In addition, the maintenance cost required for 15 years was included. This 15-year time horizon is the expected lifetime of the switchgear automation.

The research results show that it is not necessary to have all substations automated as 35% of the network will provide the optimum benefits. The case study results gave between 8%

to 26% improvement as against those substations automated by the DSO and a cost savings of about 16%. The unused budget funds, which would have been spent on the remaining substations, will be utilised to improve the same network with switchgear replacement, new MV cables to interlink the feeders as well as replacing and upgrading old cables having lower ampacity.

---

## *Declaration*

---

I hereby declare that this thesis is a record of work undertaken by myself, that it has not been the subject of any previous application for a degree, and that all sources of information have been duly acknowledged.

© Copyright 2022, John Caruana

---

## *Acknowledgements*

---

I would like to express my gratitude to my supervisors Professor Phil Taylor, Dr. Simon Blake, Dr. Neal Wade, Dr. Ilias Sarantakos and Professor Damian Giaouris. As a part-time PhD student, it was a long and challenging journey, many times interrupted by the Covid-19 pandemic. I was blessed to be guided and supported by all. Phil and Simon guided me in the first years of my research. Phil has now moved on to another University and Simon is happy his retirement. Neal was instrumental to steer me in exploring more avenues in my research. He has now moved to a Distribution System Operator (DSO), perhaps, my DSO work experience inspired him to move from the academia to industry. I am sure his wealth of knowledge will be beneficial to the DSO.

Ilias and I went through many discussions either in person, at the University, or online. His patience, criticism and guidance are much appreciated. He was always a catalyst in my research and without his help and support, this work would not have been possible. Damian took over from Neal and his direct and to-the-point guidance helped me to stay focused till the end. Thank you all.

I am sincerely grateful to my employer, Enemalta plc, the Maltese sole DSO, for giving me the opportunity and permission to do a case study for the distribution network in Gozo and Bugibba. This was possible through the former Executive Chairman Ing. Fredrick Azzopardi, Ing. Jonathan Scerri, Executive Director (Business Strategy and Operations), now Chairman, and ex Divisional Manager Distribution, Ing. Carmel Xerri. They believed in my innovative proposals and research, and together we initiated the process to automate the Maltese 11kV network with several substations.

The result of this is that restoration of supply improved for the benefit of Enemalta plc customers. An appreciation goes to all the colleagues at Enemalta plc who assisted me in the execution of the substation automation project in Malta and Gozo, especially maintenance engineers Ing. David Azzopardi, Ing. Miguel Borg and Ing. Josef Micallef. Others offered their assistance and moral support throughout this research, not least Ing. Josephine Vella, Distribution Manager and Ing. Josef Micallef, maintenance engineer, both responsible for Gozo, for the lengthy discussions about the 11kV network in Gozo.

I am grateful to the Government of Malta who partially funded my research through the Malta Government Sponsorship Scheme (MGSS). Postgraduate education forms an increasingly important pillar of Malta's economic and social agenda. It is a key element in lifelong learning and contributes towards research in identified areas of national priority.

Last, but not least, I want to convey my great appreciation to my wife Gemma for the great and unlimited support she always gives me. She was always patient and understanding throughout this trajectory and is an outstanding mother of my children Martina and Matthew. I cannot find enough to express my gratitude for her support, which boosted me whenever difficulties arose.

---

*Dedication*

---

**I dedicate this work to our son MATTHEW.**

**Your neurodegenerative condition is your ability to keep me going  
to find the strength to persevere and endure in spite of  
overwhelming obstacles.**

**Your contagious smile makes our life more beautiful.**

**Thanks for being there.**



---

## Acronyms

---

**Acronym**   **Description**

CAIDI	Customer Average Interruption Duration Index
CB	Circuit Breaker
CMI	Customer Minutes of Interruption
CML	Customer Minutes Lost
DMS	Distribution Management System
DNO	Distribution Network Operator
DSO	Distribution System Operator
EAB	Enemalta Administration Building
EENS	Expected Energy Not Supplied
EFI	Earth Fault Indicator
ENA	Energy Networks Association
ENIC	Energy Networks Innovation Conference
ERACS	Electrical Power Systems Analysis Software
ESS	Energy Storage Systems
FAIDI	Feeder Average Interruption Duration Index
GA	Genetic Algorithm
HV	High Voltage
IAC	Internal Arc Classification
IDMT	Inverse Definite Minimum Time protection relay curve (IEC 60255)
LCNI	Low Carbon Networks Innovation
LV	Low Voltage

***Acronym Description***

MLO	Manual Local Operation
MRO	Manual Remote Operation
MV	Medium Voltage
NCR	Network Control Room
NEDeRS	National Equipment Defect Reporting Scheme
NOP	Normally Open Point
NOT	Normal Operating Time
ORT	Operational Restrictions Time
PLC	Power Line Communication
PV	Photovoltaic
RES	Renewable Energy Sources
RLR	Reduction in Lost Revenue
ROD	Remote Operating Device (used to operate MV switchgear at a safe distance)
RTU	Remote Terminal Unit (This includes the motorised actuators)
SAIDI	System Average Interruption Duration Index
SAIFI	System Average Interruption Frequency Index
SAT	Site Access Time
SCADA	Supervisory, Control and Data Acquisition
SLT	Substation Location Time
SOP	Suspension Of Operational Practice (issued by ENA members through NEDeRS)
SS	Substation
TLF	Time Limit Fuse

---

## *Nomenclature*

---

<b><i>Nomenclature</i></b>	<b><i>Description</i></b>	<b><i>Units</i></b>
$CML_{bf}$	Customer Minutes lost for a branch fault	min
$CML_{dw}$	CML for downstream substations	min
$CML_{fb}$	Customer Minutes lost from faulted buses	min
$CML_{rb}$	Customer Minutes lost from restorable buses	min
$CML_{SSI}$	Customer Minutes lost based on substation importance (SSI)	min
$CML_{up}$	CML for upstream substations	min
$ECOST_{frb}$	Cost of energy not supplied for faulted and restorable buses	Euro
$ECOST_y$	Cost of energy calculated on several years	Euro
$EC_{NO}$	Energy Cost for Normal Operational Time	Euro
$EC_{OR}$	Energy Cost for Operational Restriction Time	Euro
$EC_{SA}$	Energy Cost for Site Access Time	Euro
$EC_{SL}$	Energy Cost for Substation Location Time	Euro
$E_p$	The energy tariff charged to customers per kWh.	Euro
$FC_n$	Outgoing feeder from substation.	
$FNOP$	Feeder Normally Open Point	
$IR$	Interest Rate	
$i$	Branch fault being calculated	
$j$	Substation number used in calculations	
$LC_{eng}$	Engineer labour cost per hour	Euro
$LC_{NO}$	Labour Cost for Normal Operation Time	Euro
$LC_{OR}$	Labour Cost for Operational Restriction Time	Euro

<b><i>Nomenclature</i></b>	<b><i>Description</i></b>	<b><i>Units</i></b>
LC <sub>SA</sub>	Labour Cost for Site Access Time	Euro
LC <sub>SL</sub>	Labour Cost for Substation Location Time	Euro
N <sub>dw</sub>	Number of customers downstream to the faulty branch	
N <sub>j</sub>	Number of customers connected to substation 'j'	
N <sub>up</sub>	Number of customers upstream to the faulty branch	
OUTF	Outgoing Feeders from substation	
P <sub>j</sub>	Substation peak power demand in kW at substation 'j'	kW
RoI	Return of Investment	Euro
S <sub>j</sub>	Substation transformer rating in kVA at substation 'j'	kVA
SSI	Substation Importance	
SS <sub>n</sub>	Number of automated substations	
SSP	Substation Points	
SSV	Substation importance value	
SWCC <sub>n</sub>	Switch capital cost for all automated substations	Euro
SWMC	Switch maintenance Cost	Euro
SWMC <sub>y</sub>	Switch maintenance Cost calculated on several years	Euro
T	Interruption Time	min
TEC <sub>SS</sub>	Total Energy Cost for the substation	Euro
TEC <sub>up</sub>	Total Energy Cost for the substation upstream to the branch fault	Euro
TEC <sub>dw</sub>	Total Energy Cost for the substation downstream to the branch fault	Euro
TFP	Total Feeder Points	
TFPI	Total Feeder Points for substation importance	
TLC <sub>eng</sub>	Total labour cost of engineer, officer, and vehicle	Euro
TLC <sub>up</sub>	Total labour cost of engineer, officer, and vehicle upstream to the branch fault	Euro

<b><i>Nomenclature</i></b>	<b><i>Description</i></b>	<b><i>Units</i></b>
$TLC_{dw}$	Total labour cost of engineer, officer, and vehicle downstream to the branch fault	Euro
$T_{ML}$	Manual local operation time at the substation	min
$T_{MR}$	Manual remote operation at the NCR	min
$T_{NO}$	Normal Operation Time	min
$T_{OR}$	Operational Restriction Time	min
$T_{SA}$	Site Access Time	min
$T_{SL}$	Substation Location Time	min
$VOLL_{SS}$	Value of Lost Load for the substation	Euro
$VOLL_{up}$	Value of Lost Load upstream to the branch fault	Euro
$VOLL_{dw}$	Value of Lost Load downstream to the branch fault	Euro

# Table of Contents

List of Figures.....	xvi
List of Tables.....	xviii
Chapter 1 - Introduction.....	1
1.1 Distribution network background.....	1
1.2 SCADA applied HV network, down to 33kV.....	1
1.3 Smart meters installed in Low Voltage grids.....	2
1.4 DMS for the 11kV network.....	2
1.5 Distribution Systems reliability.....	2
1.6 Distribution System Operators investments.....	3
1.7 What is being introduced.....	4
1.8 Contribution from this work.....	5
1.9 Chapters outline.....	7
Chapter 2 - Literature review.....	10
2.1 Distribution System operations.....	10
2.2 Soft Open Point (SOP).....	12
2.3 Network losses and voltage control.....	13
2.4 Demand Side Management.....	15
2.5 Demand Side Response (DSR).....	16
2.6 Active Power Curtailment (APC).....	17
2.7 Autonomous Voltage Control (AVC).....	18
2.8 Distributed Generation Photovoltaic (DGPV).....	20
2.9 Fault Tree analysis (FTA).....	21
2.10 Selection of best locations.....	22
2.11 The Maltese power system.....	26
2.12 Summary.....	30
Chapter 3 - Substations ranking for actuator placing.....	33
3.1 Methodology.....	33
3.1.1 Connected customers per substation.....	34
3.1.2 Type of customers.....	34
3.1.3 Access to the substation.....	34
3.1.4 Travelling duration and parking considerations.....	35
3.1.5 Switchgear operational restrictions.....	35
3.1.6 Substation feeder's layout.....	35

3.1.7 Schematic diagram for an 11kV network.....	36
3.1.8 Mathematical formulation .....	37
3.2 Example for an 11kV network.....	39
3.3 Case study for the Bugibba 11kV network .....	44
3.3.1 Ranking without substation importance.....	47
3.3.2 Ranking with substation importance .....	52
3.4 Case Study – Restoration time for an 11kV cable fault in Bugibba .....	58
3.4.1 Travelling and Restoration time .....	60
3.4.2 Sequence of events considering substations without automation .....	62
3.4.3 Sequence of events considering a substation with automation (Qawra Manor)....	63
3.4.4 Lost Revenue for the Distribution System Operator .....	64
3.5 Summary .....	69
Chapter 4 - Optimum locations considering restoration time .....	71
4.1 Methodology.....	71
4.1.1 Genetic Algorithm (GA) optimisation function .....	72
4.1.2 Distribution System Operator financial budget .....	72
4.2 Restoration of supply .....	74
4.2.1 Normal Operating Time (NOT) .....	74
4.2.1.1 Manual Local Operation (MLO) .....	74
4.2.1.2 Manual Remote Operation (MRO) .....	75
4.2.2 Additional restrictions time.....	75
4.2.2.1 Site Access Time (SAT) .....	75
4.2.2.2 Operational Restriction Time (ORT) .....	76
4.2.2.3 Substation Location Time (SLT) .....	77
4.3 Operational time duration .....	77
4.4 Network automated methods to be considered .....	80
4.5 Customer Minutes Lost (CML) .....	81
4.6 Substation data .....	85
4.7 Two-feeder network with 11 substations.....	86
4.7.1 Substations without any restrictions .....	87
4.7.2 Substations with restrictions.....	91
4.8 Four-feeder network with 21 substations .....	97
4.8.1 Substations without any restrictions .....	99
4.8.2 Substations with restrictions.....	103

4.9 Summary .....	107
Chapter 5 - Optimum locations using FAIDI and the cost of lost load .....	108
5.1 System Indices used in power systems.....	109
5.1.1 SAIFI: System Average Interruption Frequency Index .....	109
5.1.2 SAIDI: System Average Interruption Duration Index .....	110
5.1.3 CAIDI: Customer Average Interruption Duration Index .....	110
5.1.4 FAIDI: Feeder Average Interruption Duration Index.....	111
5.2 Cost of Energy not supplied (or Energy Cost) .....	120
5.2.1 Substation transformer rating in kVA .....	121
5.2.2 Peak power supplied by a substation transformer .....	123
5.3 Two-feeder network with 11 substations.....	124
5.3.1 Transformer rating in kVA .....	124
5.3.2 Transformer peak loading in kW .....	128
5.4 Four-feeder network with 21 substations .....	131
5.4.1 Transformer rating in kVA .....	131
5.4.2 Transformer peak loading in kW .....	137
5.5 Substation customer type.....	144
5.6 Value of Lost Load (VOLL) .....	145
5.6.1 Two-feeder network.....	148
5.6.2 Four-feeder network .....	150
5.7 Automation cost, maintenance cost and budget availability .....	152
5.7.1 Return of Investment (RoI).....	153
5.7.2 Two-feeder network.....	155
5.7.3 Four-feeder network .....	158
5.8 Substations which have been previously automated.....	162
5.8.1 Two-feeder network.....	163
5.8.2 Four-feeder network .....	165
5.9 Summary .....	169
Chapter 6 - Case study for the Maltese Islands MV network.....	171
6.1 Gozo 11kV network.....	172
6.2 Customer Minutes Lost (CML) .....	174
6.2.1 Substations without any restrictions .....	175
6.2.2 Substations with actual restrictions.....	177
6.3 FAIDI for Gozo network.....	181



6.4 Cost of Energy Not Supplied .....	185
6.5 Value of Lost Load.....	188
6.6 Automation and maintenance cost based on 15 years. ....	189
6.7 Considering already automated substations.....	192
6.7.1 FAIDI .....	192
6.7.2 ECOST and maintenance for 15 years.....	199
6.8 Summary.....	204
Chapter 7 - Discussion .....	205
7.1 Introduction .....	205
7.2 Initial concepts for distribution network operations .....	206
7.3 Optimisation methodologies .....	207
7.4 Cost of lost energy .....	207
7.5 Real MV network optimisation .....	208
7.6 Summary .....	209
Chapter 8 - Conclusion .....	210
8.1 Introduction .....	210
8.2 Important findings .....	210
8.3 Research objectives .....	211
8.4 Summary .....	212
8.5 Future research.....	212
References.....	213
Appendix A    MATLAB Genetic Algorithm .....	218
Appendix B    Case Study, FAIDI applied to an 11kV feeder fault .....	222

## List of Figures

Figure 2-1 Telecommunications architecture for voltage regulation by multiple DGPV systems .....	21
Figure 2-2. Classical power system.....	26
Figure 2-3. Typical voltages at high load .....	27
Figure 2-4. Typical voltages at low load and if no transformer voltage regulation is applied .	27
Figure 2-5. Typical MV and LV network.....	28
Figure 2-6. Typical 11kV network connecting two primary substations.....	28
Figure 2-7. PV Installations in Malta. Courtesy of Enemalta plc© .....	29
Figure 3-1. Part of an 11kV network. Courtesy of Enemalta plc© .....	36
Figure 3-2. An 11kV meshed network model with Normal Open Points .....	41
Figure 3-3. Circuit layout for Feeder No 1 .....	42
Figure 3-4. Single line diagram for substation No 11 .....	42
Figure 3-5 - Substations in Bugibba area. Courtesy of Enemalta plc© .....	45
Figure 3-6. Feeder from Bugibba DC to Qawra Manor INV substation. Courtesy of Enemalta plc© .....	58
Figure 3-7. EAB to Qawra Manor Inv substation.....	60
Figure 3-8. Qawra Manor Inv substation to Qawra Costa San Antonio substation .....	61
Figure 3-9. EAB to Qawra Costa San Antonio substation .....	61
Figure 3-10. Timeline without automation .....	63
Figure 3-11. Timeline with automation .....	64
Figure 4-1. Google Map driving time. Engineers' office to substation. ....	79
Figure 4-2. Optimisation Flow Chart .....	84
Figure 4-3. Two-feeder network single line diagram .....	86
Figure 4-4. Two-feeders - CML vs RTU Cost for all automated substations.....	90
Figure 4-5. Two-feeders - CML vs RTU Cost considering budget only, excluding already automated substations.....	90
Figure 4-6. Two-feeders - CML vs RTU Cost for all automated substations considering restrictions.....	93
Figure 4-7. Two-feeders - CML vs RTU Cost considering budget only, excluding already automated substations.....	93
Figure 4-8. Chart for percentage improvement per budget increment.....	95
Figure 4-9. CML percentage overall improvement .....	97
Figure 4-10. Four-feeder network single line diagram.....	98
Figure 4-11. Four-feeders - CML vs RTU Cost for all automated substations without restrictions.....	102
Figure 4-12. Four-feeders - CML vs RTU Cost considering budget only, excluding already automated substations.....	102
Figure 4-13. Four-feeders - CML vs RTU Cost for all automated substations with restrictions .....	106
Figure 4-14. Four-feeders - CML vs RTU Cost considering budget only, excluding already automated substations.....	106
Figure 5-1. MV feeder with only the NOP automated .....	112

Figure 5-2. Feeder flow chart to compute FAIDI .....	113
Figure 5-3. Two-feeder - FAIDI vs RTU Cost for all automated substations.....	115
Figure 5-4. Two-feeders - FAIDI vs RTU Cost considering budget only, excluding already automated substations.....	115
Figure 5-5. Four-feeders - FAIDI vs RTU Cost for all automated substations.....	119
Figure 5-6. Four-feeders - FAIDI vs RTU Cost considering budget only, excluding already automated substations.....	119
Figure 5-7. Tow-feeders - Transformer rating (kVA) without restrictions .....	125
Figure 5-8. Tow-feeders - Transformer rating (kVA) with restrictions.....	127
Figure 5-9. Tow-feeders - Transformer peak load (kW) without restrictions .....	129
Figure 5-10. Tow-feeders - Transformer peak load (kW) with restrictions.....	131
Figure 5-11. Four-feeders - Considering transformer rating (kVA) without restrictions .....	134
Figure 5-12. Four-feeders - Considering transformer rating (kVA) with restrictions.....	137
Figure 5-13. Four-feeders - Considering transformer peak load (kW) without restrictions ..	140
Figure 5-14. Four-feeders - Considering transformer peak load (kW) with restrictions .....	143
Figure 5-15. Tow-feeders - VOLL results when optimum values are reached .....	149
Figure 5-16. Four-feeders - VOLL results when optimum values are reached.....	152
Figure 5-17. Two-feeders - Rol vs RTU Cost for all automated substations.....	156
Figure 5-18. Tow-feeders - Rol vs RTU Cost considering budget only, excluding already automated substations.....	157
Figure 5-19. Return of Investment against the cost of RTUs .....	157
Figure 5-20. Four-feeders - Rol vs RTU Cost for all automated substations.....	161
Figure 5-21. Four-feeders - Rol vs RTU Cost considering budget only, excluding already automated substations.....	161
Figure 5-22. MV feeder with SS4 already automated .....	162
Figure 5-23. Two-feeders - ECOST considering transformer peak load (kW) with two substations already automated.....	165
Figure 6-1. The Maltese Islands.....	171
Figure 6-2. Gozo MV network. Courtesy of Enemalta plc® .....	173
Figure 6-3. Gozo CML results without restrictions.....	175
Figure 6-4. Gozo CML results with restrictions .....	177
Figure 6-5. FAIDI in minutes .....	182
Figure 6-6. FAIDI in minutes with full budget.....	183
Figure 6-7. ECOST for transformer kVA rating and without restrictions.....	185
Figure 6-8. ECOST for transformer kVA rating and with restrictions .....	186
Figure 6-9. ECOST for transformer kWp rating and without restrictions .....	187
Figure 6-10. ECOST for transformer kWp rating and with restrictions .....	187
Figure 6-11. ECOST and maintenance cost for 15 years .....	189
Figure 6-12. ECOST and maintenance cost for 15 years with full budget.....	190
Figure 6-13. Feeder fault between source CB and SS 131 .....	197
Figure A-1. GA Flow chart.....	220
Figure A-2. Copy of a Genetic Algorithm process.....	221

## List of Tables

Table 3-1. Substation Importance ranking value .....	39
Table 3-2. Substation points value results .....	43
Table 3-3. Feeder points considering substation points only and including substation importance .....	44
Table 3-4. Substations Location ranking-2016-Data .....	46
Table 3-5. Feeder ranking - FNOP+1.....	47
Table 3-6. Substation ranking for each feeder – FNOP+1 .....	48
Table 3-7. Feeder ranking - FNOP+3.....	50
Table 3-8. Substation ranking for each feeder – FNOP+3 .....	50
Table 3-9. Feeder ranking considering substation importance – FNOP+1.....	53
Table 3-10. Substation ranking for each feeder considering substation importance – FNOP+1 .....	53
Table 3-11. Feeder ranking considering substation importance – FNOP+3.....	55
Table 3-12. Substation ranking for each feeder considering substation importance – FNOP+3 .....	55
Table 3-13. Lost revenue assuming consumption of one kWh per meter .....	66
Table 3-14. Lost revenue considering actual consumption .....	67
Table 4-1. RTU Type typical costs .....	73
Table 4-2. Operational Time Code and expected restoration time .....	78
Table 4-3. GA Parameters.....	81
Table 4-4. Type of RTUs .....	86
Table 4-5. Data for a two-feeder network .....	87
Table 4-6. Data for two-feeder networks without any restrictions .....	88
Table 4-7. CML Results for a network with two feeders and without restrictions .....	89
Table 4-8. Data for two-feeder networks with restrictions .....	91
Table 4-9. Results for two-feeder networks with restrictions .....	92
Table 4-10. CML Percentage improvement between budget increments.....	94
Table 4-11. CML improvement, no substations automated against the budget increment ...	96
Table 4-12. Data for four-feeder network.....	98
Table 4-13. Data for four-feeder networks without restrictions .....	99
Table 4-14. Results for four-feeder networks without restrictions .....	100
Table 4-15. Results for four-feeder networks without restrictions - substations.....	101
Table 4-16. Data for four-feeder networks with restrictions.....	103
Table 4-17. Results for four-feeder networks with restrictions.....	104
Table 4-18. Results for four-feeder networks with restrictions - substations .....	105
Table 5-1. FAIDI results for two-feeder networks .....	114
Table 5-2. FAIDI results for four feeders' networks .....	117
Table 5-3. FAIDI substations location for four-feeder networks.....	118
Table 5-4. Energy Cost results for transformer rating without restrictions.....	125
Table 5-5. Energy Cost results for transformer rating with restrictions .....	126
Table 5-6. Energy Cost results for transformer peak load without restrictions .....	128
Table 5-7. Energy Cost results for transformer peak load with restrictions .....	130

Table 5-8. Energy Cost results for transformer rating without restrictions.....	132
Table 5-9. Energy Cost results for transformer rating without restrictions - substations .....	133
Table 5-10. Results for transformer rating with restrictions.....	135
Table 5-11. Results for transformer rating with restrictions - substations.....	136
Table 5-12. Energy Cost results for transformer peak load without restrictions .....	138
Table 5-13. Energy Cost results for transformer peak load without restrictions - substations .....	139
Table 5-14. Energy Cost results for transformer peak load with restrictions .....	141
Table 5-15. Energy Cost results for transformer peak load with restrictions - substations ..	142
Table 5-16. Substation Importance ranking .....	144
Table 5-17. VOLL Results for a two-feeder network .....	148
Table 5-18. VOLL Results for a four-feeder network.....	150
Table 5-19. VOLL for a four-feeder network – selected substations .....	151
Table 5-20. RoI results for two-feeder networks .....	156
Table 5-21. RoI results for four-feeder network .....	159
Table 5-22. RoI results for four-feeder network – recommended substations .....	160
Table 5-23. Results without substations already automated .....	163
Table 5-24. Results with substations already automated .....	164
Table 5-25. Results without substations already automated .....	166
Table 5-26. Results without substations already automated - locations.....	167
Table 5-27. Results with substations already automated .....	168
Table 5-28. Results with substations already automated - locations .....	169
Table 6-1. Algorithm data .....	173
Table 6-2. Quantity of substations that can be automated .....	176
Table 6-3. Quantity of substations with restrictions that can be automated.....	178
Table 6-4. Comparing the selected substations without restrictions against those with restrictions.....	180
Table 6-5. FAIDI in minutes for full budget .....	184
Table 6-6. VOLL with substation restrictions results.....	188
Table 6-7. ECOST for 15 years with full budget.....	191
Table 6-8. FAIDI for existing substations .....	193
Table 6-9. FAIDI for the proposed substations.....	194
Table 6-10. FAIDI - Existing and proposed substation names .....	196
Table 6-11. Proposed substations for automation.....	198
Table 6-12. Compared results for an actual feeder fault .....	198
Table 6-13. ECOST for 15 years with existing automated substations.....	199
Table 6-14. ECOST for 15 years for the proposed automated substations.....	200
Table 6-15. ECOST - Existing and proposed substation names .....	203
Table A-1. Typical GA parameters .....	219
Table B-1. Automated substations node numbers.....	222
Table B-2. Results for a branch fault with existing automated substations .....	223
Table B-3. Results for the same branch fault but with the proposed automated substations .....	224



# Chapter 1 - Introduction

## 1.1 Distribution network background

Distribution Network Automation is being introduced as part of the Smart Grid implementation. Present high voltage (HV) and part of the medium voltage (MV) networks, 33kV and above, are being extended and modified so that they will be able to meet the increase in electrical demand and the changes to the Power Generation Sector. Past analysis showed that during peak demand periods many components of the HV network are being operated close to their maximum capacity and without any redundancy [1], [2]. This means that in the short-term, significant parts of the network will be unable to meet the peak demand in case of a failure of one of the main components. Furthermore, significant parts of the network will be unable to meet the expected increase [1], [2] in demand in the long-term, should load growth increases significantly.

## 1.2 SCADA for HV and MV networks

In line with these concerns and to improve security of supply, Distribution System Operators (DSO) have already installed SCADA systems that provide continuous monitoring of the traditionally unmanned 33kV, 132kV or higher primary substations, giving timely warning of abnormal operating parameters before failure and interruption occur. Switching operations will be performed remotely from a central control room, enabling improved response to system disturbances, and limiting the risk of blackouts. Furthermore, SCADA systems provide data essential for network operation and planning studies.

### 1.3 Smart meters installed in Low Voltage grids

At the same time, DSOs are implementing smart metering on the Low Voltage (230/400V) network. This consists of the replacement of all energy meters installed in households, industries, and commercial outlets with new smart meters. These smart meters usually communicate via Power Line Communication (PLC) to centralised concentrators in the distribution substations from where data is then transferred to centralised servers over the GSM network. Other means of communication are also being used.

### 1.4 Distribution Management Systems for the 11kV network

To implement a full Smart Grid infrastructure and to address the missing link between the existing automation at the 33kV or higher voltage levels and the automation at the low voltage level, Smart Metering Network, DSOs are establishing the Distribution Network Automation Plan to implement SCADA or better Distribution Management Systems (DMS) further down, at the 11kV distribution substations level. Automated distribution substations can provide real time data which can be managed by the Network Control Room engineers. These engineers will also have the facility to control remotely equipment in Distribution Substations to isolate and re-configure the 11kV network, as necessary. The aim is to improve the network performance in terms of customer interruption duration, quality of supply voltage, operational and maintenance practices thus contributing to improving energy efficiency and security of supply.

### 1.5 Reliability of Distribution Systems

Distribution System Operators have an obligation to provide a reliable energy supply to their customers. Apart from the electricity supply quality, such as voltage, frequency, harmonics etc, restoration of supply, following a fault on the network, is another measure that a typical DSO looks at. System reliability indices have been adopted both in North America and in Europe. The scope of these indices is to identify the level of service and then benchmark to



achieve future improvements in the service provide by the DSO. Benchmarking is also done between DSO in the same country and in a continent. Both North America and Europe do so. In Europe, each individual country has its own benchmarking levels which are imposed on DSO.

The Institute of Electrical and Electronics Engineers, IEEE, provides various standards and guidelines, one of which is IEEE-Std-1366 [3] [4]. This standard is a guide for electric power distribution reliability indices. Distribution system operators follow this standard when adopting reliability indices. Albeit the approach and the way of presenting the indices results may be different between continents or countries, the fundamental concepts are the same.

Indices look at sustained customer interruption such as SAIFI, SAIDI, CAIDI, and load and energy based, such as EENS and ECOST. Other indices look at economic and generation adequacy.

## 1.6 Distribution System Operators investments

Transforming an existing MV network into a smarter network requires a substantial investment by the responsible DSO. A smarter network may involve having remote readings and alarms, perform remote switching operations and having automatic switching operations.

Each requires specialised equipment and software to be able to achieve the desired requirements. The cost for such upgrades needs to be funded in advance and hence to obtain such funds a business case will be required. Some DSOs may be opened to invest in pilot projects to test and obtain experience in smart networks, others are reluctant to invest and may be more cautious when such request, to automate a network, are received.

In the UK, the Energy Networks Association, ENA, [5], promotes innovations initiatives to have smarter networks. The aim of such projects is to investigate any innovative technologies available and integrate them into a power system network. These are challenges that the DSO will face the more the customers' expectations increase. ENA organises events and webinars to promote and be able to share the outcome from such

innovation initiatives. One of these is the Energy Networks Innovation Conference, ENIC, formerly Low Carbon Networks Innovation, LCNI. Distribution System Operators are encouraged to participate in such innovations initiatives and to do so, funding is available.

Following pilot projects, DSOs will decide to move on and roll out the project or else shelve the same project. Moving on and rolling out a project requires additional funding and this will have to be factored in by the DSO. For any type of initiative, the question will be up to which level of funding is required and hence provide a budget for such projects.

The proposed research will take the funds available into consideration and try to optimise the budget cost against the improvement of the network operations.

## 1.7 What is being introduced

Although there have been many academic studies on designing automation schemes, they are often approached from a theoretical optimisation viewpoint. However, it is essential to approach this from an operations engineering perspective because a real network provides daily operational restrictions to a DSO, although these are not always visible from outside the DSO organisation. Nevertheless, this does have a direct impact on the quality of supply given to the DSO customers. The research will look at MV (11kV) automation, with a view to determine the most appropriate substation's locations where the automation technology can be installed as a function of network operations restrictions. The research will analyse a Maltese 11kV network, which is like DSO networks in UK. Hence what is achieved from this research is also adaptable to UK networks.

The implementation of the Distribution Network Automation research is expected to result in the following benefits (both at project level and system level):

1. Reduction in CAIDI and SAIDI for unplanned outages
2. Reduction in the number of locally performed switching operations during planned works
3. Reduction in the number of outages due to faults inside substations

4. Improved monitoring of the LV network voltages
5. Improved quality of supply
6. More efficient use of the distribution network
7. Enhanced safety

Furthermore, the knowledge of real-time current flow throughout the 11 kV network (because of the proposed research) will permit optimisation of the network operating configuration and lead to a reduction of losses. At present, the medium voltage (MV) networks are configured according to the combined requirements of meeting the summer and winter peak demand, based on a snapshot of load readings taken during these peak periods. The availability of real-time power flows on the entire network will facilitate the analysis of the network as the load varies daily and seasonally. Different switching configurations will be implemented through the remote control of switching devices in substations, to ensure that the network is always operated in the configuration that results in the minimum network losses (saving also related to carbon emissions).

## 1.8 Contribution from this work

The work done in this research presented an innovative approach of how substation locations are selected to optimise the network operations of a distribution network. By considering different operational aspects that engineers meet, while performing switching operations to restore the supply, it was necessary to have a method where the restoration time is reduced as much as possible.

The author, throughout his work experience, experienced first-hand site restoration operational switching, distribution network control room operations, substations upgrade and substations maintenance. He was a catalyst to introduce the SCADA system for the 33kV and 132kV network and later the 11kV substation distribution automation. All this led to the author to investigate the idea to having a means where substations selected for automation in a particular network are done through an optimisation method that reflects the real

constraints of the same network. The DSO engineers should be able to input, into the optimisation method, the constraints that are encountered during site restoration operational switching.

Existing MV networks may be fully automated but this requires substantial investment. Therefore, it is critical to identify the best substations' locations where remote operating devices can be installed.

Each substation is equipped with MV switchgear that was provided by different suppliers, with the result that each supplier has its own automation equipment that can retrofit to the supplier equipment. The cost to automate the switchgear varies between different suppliers. A DSO must allocate a budget for the distribution automation in its yearly financial budget. This entails that the selected substations must provide the optimum network switching operation to ensure that customers have their supply restored in the least time possible to reduce the cost of energy not supplied. The DSO board of management expects that engineers identify the best substations locations that provide optimum restoration time but with the least possible investment cost.

The solutions formulations presented in this research consider the budget availability and the actual cost of the automation equipment required for each type of switchgear. By doing so, the optimum selection of substations to be automated based on the optimum result for customer minutes lost and cost of energy not supplied, are determined.

The contributions from this research are:

1. Describing how actual restoration time restrictions are identified;
2. An optimisation method that includes the site restrictions experienced daily;
3. Examine and compare optimisation results based on transformer rating and transformer peak power; and
4. A method, where, for a given budget, the optimum substations location, which will provide the least time to restore supply, is given.

## 1.9 Chapters outline

Chapter 2 reviews the literature read throughout the research period and that contributed to the knowledge gained and directed the researcher to explore areas that are related to MV operations but from a different practical perspective.

Chapter 3 describes the initial thoughts how the duration to restore supply, experienced from the site can be translated and presented in a mathematical form. Certain problems that arise on site and that contribute to the delay in restoring the supply may not always be visible from the academic point of view but are experienced continuously by site engineers and at the end, these delays directly affect the customers themselves. The practical delays were identified, explained, and implemented in an empirical way to obtain a result. Such results can then be used to rank substations where potentially these can be equipped with switchgear automation that can be used to restore the supply more rapidly. A case study was carried out using part of an 11kV network and substations were ranked accordingly.

Chapter 4 used the site delay constraints and used these in the reliability indices. The delays arising from such constraints were translated to minutes and included in the Customer Minutes Lost value. For each network branch fault, CML can be obtained using the defined site minutes and used to identify the best substation locations where automated switchgear can be installed. MATLAB [6] was used and a code was written to represent the CML and cost functions. DSOs that do not have data of how many customers are connected to a transformer use the transfer rating in kVA and assume that 1kVA is one customer.

The work presented in this chapter define the quantity of customers based on the number of energy meters connected to the substation transformer. This represents the exact number of customers and is obtained from the smart metering system.

Three different networks were used in this analysis, having two, three and four feeders, each with five substations. This was made to test the algorithm for different networks. The networks with two and four feeders will be presented with results.

An estimated cost for automation was applied and the proposed algorithm considered the budget available and the actual cost if the switchgear type is known.

Chapter 5 delved with what was analysed in Chapter 4. System indices are used and FAIDI, instead of CAIDI [3] was presented to give a better reflection of what a customer will experience at feeder level, rather than at network level. Work in this chapter also presents energy cost based on transformer ratings. The analysis is improved by looking at actual peak load of a transformer because the transfer rating may not reflect the actual customer loads and the energy consumed.

This research also looks at the type of customer or customers being supplied by a substation. This is important if the CML is based on the number of customers rather than the transformer rating. As an example, a dedicated substation that supplies only one customer who is a heavy consumer in terms of power, will not give the correct representation value of its importance. Moreover, some substations which supply only one customer may have strategic importance in the network of a DSO. Some examples are hospitals, factories, police, military, civil protection, etc. a weighting for these types of dedicated substations was proposed and used to obtain the value of lost load.

Finally, the same analysis was done for several years, in this case 15 years which is a typical lifetime of automation components and the maintenance cost for the same duration.

The same networks used in Chapter 4 were again analysed using the previously mentioned methods.

Chapter 6 is a case study looking at a real 11kV network in Malta having 144 substations. This is the 11kV network in Gozo which is Malta's sister island. The network has two primary substations.

The methodology in Chapter 4 and 5 was used to analyse this network and the results obtained followed the same patterns as those obtained for the two, three and four feeders. The graphs obtained had some discrepancies, but this was expected due to the fact that a real network has much more substations with multiple interconnections and several spurs. Spur branches substations had their customers added to the substation supplying the spur branch.

However, the graphs gave some valuable information indicating that it is not necessary to automate all substations. The studies show that at some point, the percentage gain saturates and will not improve if more substations are automated. It also shows that the amount of money that can be budgeted can be reduced and used to improve the network somewhere else, such as adding or replacing new cables or overhead lines.

Chapter 7 discuss the outcome results from this research on what was achieved from this research. The methodology developed and tested on three types of networks indicted that it is not necessary to have all substations automated. Improvement achieved with the proposed methods show that customer minutes lost, cost of energy not supplied and return on investment will be improved using the proposed method.

Chapter 8 is the conclusion on the achievements reached. Future studies to improve the methodology presented and to explore other network requirements are also provided. They will further enhance the achievements obtained through this research and will indicate areas where further research can develop in the coming years.

## Chapter 2 - Literature review

The literature review during the research period evolved from a wider perspective to that focusing on the actual area of research. Being exposed to site experiences and various developments and innovative technologies arising in various countries, it was natural that the interest was prevalent. The following reviews will follow the research period and outcomes.

### 2.1 Distribution System operations

Renewable energy sources, RES, are being connected to LV systems as part of government and EU policies [7] to ensure that reduction in CO<sub>2</sub> coming from traditional generating plants working on heavy fuel oil or coal is implemented. This also applies to the Maltese Islands. However, RES are more focused on PV systems. Household PV systems are in the range of 1kW to 4kWp capacity. On their own, these do not constitute any problem to the LV system. However, when their installation is increased, the LV system will experience problems such as voltage rise. This will influence the customer's voltage quality. The more you have the more power will be injected in the LV system. This will happen at a time during the day where few customers are at home. This means that reverse power is fed back to the distribution substation transformer. A typical transformer rating may be 500, 800 or 1000kVA with around 5 to 8 LV feeders being fed from the transformer.

If some feeders have a high penetration of PV systems and another one within the same substation does not have, then there will be power flows from one feeder to the other. At this point the load on the transformer is lower than it should be if no PV systems are connected. However, it is a known fact that if one customer installs a PV system, the neighbourhood customers will follow suit. This will result that all feeders supplied from the same substation will have a substantial number of PV systems installed. The fact that they are concentrated in the same location, they will be producing at the same time. Hence generated power will exceed the demand in that location.



The excess power generated will have to flow upstream through the distribution substation transformer. This power will be fed into the 11kV distribution network. Again, an 11kV feeder will supply a cluster of substations normally geographically near each other. This means that what is being experienced in the case of the LV feeders will also be experienced in the case of the 11kV feeders soon.

11kV feeders are normally operated radially with open points (NOP). Open points are selected following a network load flow study, where capacity of cables and voltage regulation is to be respected. Having power flows coming from the LV side will alter the traditional load flows. In addition, it is expected that larger PV installations, PV farms, will be connected directly to the 11kV distribution network. This means that managing the 11kV network is not any longer the traditional way where you analyse, plan, and set the open points and they remain so if no faults occur on the network or new substations are connected.

Open points, now, require being more flexible [8]. They can be called Flexible Open Points (FOP), so that power flow and voltage changes are managed more frequently and when required. This is required rather than when problems are reported, analysed and action taken which may result in several days in delay.

MV distribution networks have operational procedures set for both normal and abnormal operations. During normal operations, voltage levels must be kept within standards and network assets loaded within their normal operating capacity. Power flow studies and fault analysis are done to define the correct configuration of multiple feeders within a distribution network. Daily operations requires that equipment within substations, overhead lines and cables are isolated for maintenance. This means that a network must be reconfigured to supply loads from other feeders. RES generation into the network will cause changes in power direction and voltage levels, so temporary reconfiguration may be required during the RES generation period. The same will apply when changes in load occur, such as peak periodic loads, resulting from traditional loads and nowadays from EV charging. Reconfiguration may be necessary due to temporary or permanent load transfer, seasonal reconfiguration or daily dynamic reconfiguration to take advantage of any difference in peak demand timing. Reconfiguring the network requires a number of switching operations, such as switching off part of a feeder and then re-energise the same part from a different feeder to ensure that the supply is kept within standard limits. However, this means that some loads will have their

supply interrupted for a short period. An alternative to the standard operation procedure is to do such switching operation by interconnecting feeders and then isolate the branch or substation, hence avoiding interruption of loads. During the period where the feeders are interconnected, power flows in either direction will occur depending on the network impedance and the generation sources. Such network behaviour may cause unwanted trips arising mainly from overloads and in some instances from voltage rise.

When abnormal operations happen, such as branch faults, equipment failures and external disturbances, the distribution network must respond quickly to mitigate the disturbance and isolate the fault, in some instances affecting non-faulty branches. Following this, energising back the non-faulty branches is necessary so that all connected loads are supplied back with energy. Such operational procedures require various switching operations by opening and then closing a number of switching points.

Flexible Open Points, FOP, operated both locally and remotely, will assist network operators to achieve network stability during normal and abnormal network operation.

## 2.2 Soft Open Point (SOP)

The effects from closing directly NOP can be mitigated by introducing what are called Soft Open Points (SOP) [9], [10], [11]. Active control of power flows and bus voltages can be controlled using MV power electronics switches. Four-quadrant convertors can provide reactive power support and voltage control at each end of the link. While voltage and power control are controlled through these convertors, fault levels are unaffected; therefore, protection schemes settings should remain the same although the radial feeders are now connected through the SOP.

Additional load can be accommodated by using a SOP to interconnect two feeders. Sarantakos et al. [12] propose an effective load carrying capability method to optimise and quantify the SOP capacity value. Energy storage systems (ESS) connected to an SOP will help Distribution System Operators to minimise feeder losses. System operators may buy energy from energy storage systems connected to SOPs during feeder peak loads. The losses of the energy storage

including the SOP losses [13] must also be considered when studies are done to optimise the ESS-SOP schedule.

The implementation of power electronics into the 11kV switchgear is something that requires further in-depth research to ensure safety is maintained according to international standards. At the same time, it is important that the existing physical size of switchgear is kept in view that these need to be installed in existing substations, hence there will be physical space constraints in the substation. In addition, the network fault levels and switchgear IAC ratings must be respected.

MV DC networks [14] are an option to enhance power transfer in medium voltage distribution networks. AC distribution networks are normally operated as radial circuits with NOP between two feeders. If this NOP is fitted with a power electronic device, then the NOP can be closed through this device and allow transfer of power in both directions, hence it may be called SOP (Soft Open Point). Voltage is controlled on each side of the SOP. Looking into the SOP a DC bus is linking two AC circuits. If the DC bus can be extended further, then one can consider converting part of the MV feeder from AC to DC. This will have benefits in terms of feeder capacity, fault levels and investment in network reinforcements.

However, such DC circuits require that each substation be equipped with an inverter where space limitations may restrict such installations. On the other hand, such proposal may be used on long distribution feeders avoiding upgrades say from 11kV to 33kV.

This research [14] discusses the possibility of having a HVDC network instead of an AC MV network. Although the main aim of the research is to discuss full implementation it refers to SOP using a 12MVA at 20kV DC Soft Open Point for an 11kV network.

### 2.3 Network losses and voltage control

Meshing radial networks [8] will reduce network losses and improve voltage regulation and more renewables can be connected. However, fault levels will increase, and this may lead to a scenario where the equipment will reach its maximum rating and, on some occasions, it may also be exceeded. Traditional radial networks, fixed mesh and dynamic mesh were considered.

Comparison between these was done for voltage regulation, losses, fault levels and capacity of feeders.

A study done by Torino Polytechnic [15], discussed how a connection of PV systems along a LV feeder will cause voltage rise at the end of the feeder which may exceed the allowed upper voltage limit. Mainly results showed that voltage rise could be present for rural feeders but not for feeders installed in Arquata district of the city of Torino. This is attributed to the line impedance. The study for the city considered transformers with ratings 400kVA and 250kVA, respectively.

However, this paper did not consider power flows upstream from the LV feeder and fed into the MV network through the MV/LV transformer installed in the existing substation. Such transformer must behave as a step-up transformer for MW and as step-down transformer for MVARs. Given the ratings of the transformers, 250kVA and 400kVA it is likely that reverse power may be experienced especially if a sizeable number of PV systems are connected to the LV feeders. The substation in Malta has standard transformer ratings of 500, 800 and 1000kVA and in some older substations 1600kVA. However, one may argue that reverse power is less likely to happen. Given that more customers are connected and there is an incentive to install PV system, then, what may be experienced for smaller transformer ratings will also be experienced for higher transformer ratings in a proportional way.

In Italy, a voltage regulation project was carried out by ASM Terni S.p.A [16]. The aim was to control the voltage profile along MV feeders and the power factor correction at HV/MV primary substations. This was achieved by regulating the reactive power sources. Measurements and simulations were carried out and an optimal power flow procedure was obtained. This procedure was used to control the reactive power generated by existing generators together with a synchronous compensator. Following tests on selected feeders it was confirmed that the voltage profile was controlled within acceptable limits, power factor corrected and operating, and power losses costs were reduced. Voltage profiles were flattened, and losses were reduced by up to 10.5%. At the same time, the power factor at the transmission in-feed was kept within required limits, i.e., greater than 0.9. An Optimal Power Flow procedure was used to achieve this using MATPOWER [17] which is an open-source MATLAB power system simulation software [6].

A small village in Germany [18] with a small LV network equipped with high PV penetration, was studied to analyse the effect of high PV penetration when compared to small loads. This was done to predict what may happen on larger networks when PV penetration reaches a considerable amount in the coming years. The results showed problems with voltage rise and hence a controllable distribution transformer (CDT) was investigated. This proved to be effective and may be a solution to control voltage rise.

However, this also means that existing transformers need to be replaced by more expensive CDT transformers or else fitted by a controllable tap-Changer. The cost may be twice that of a standard transformer having an Off Load Tap Changer. Another issue will be the limiting number of taps that can be used. Although you may correct voltage by moving the tapping position, when the maximum or minimum taps are reached, voltage may keep rising with large PV penetration and with low or reducing load. If a CDT is installed a few taps are necessary per day, hence the same CDT may need more frequent maintenance and to do this, supply has to be interrupted more frequently.

## 2.4 Demand Side Management

The impact of power penetration from PV systems [19] was analysed to identify what are the limits of PV generation in a distribution network without causing problems to the power system. In the short term, stretching the limits of PV generation into the existing network is considered. In the long term one needs to look at how the same network can be operated with more flexibility. Consumption must also be accommodated and the implementation of Demand Side Management will be necessary. Implementing these will remove the upper limits boundary of PV generation. However, when considering reinforcements and new circuits, DSOs must consider PV generation from the initial design reviews. PV generation will assist power networks with peak loads during the day especially those coming from air-condition units. Demand Side Management involves electricity energy users to change their present consumption pattern to a new pattern provided that the impact is minimal on their normal daily patterns but at the same time, users can benefit from reduced bills and be in control over the energy they consume. This can also be applied to energy producers by changing the

pattern of the electricity generated at site. Various studies have been done to understand the demand response for such demand management.

## 2.5 Demand Side Response (DSR)

Capacity to Customers (C<sub>2</sub>C) Projects are being implemented by various Universities and utility organisations such as the University of Strathclyde [20], [21], University of Manchester [22], [23] and the Electricity North West [24]. Such projects are considering demand-side response (DSR) by implementing a smart distribution network. DSR increases usable network capacity by a significant percentage, claimed to be 66% [20]. This means that having interconnection between feeders reduces the need to do network reinforcements, thus reducing costs and, at the same time, allows more customers to be connected. Such DSR may challenge traditional protection systems due to higher fault levels and bi-direction fault flow currents, so this must not be overlooked. These projects are looking into voltage and thermal constrains. Having interconnections reduced the voltage constrains by 5% but thermal constrains increased by 5%.

The research done by the University of Strathclyde [21] evaluated the impact of C<sub>2</sub>C operations on power quality. It was shown that with interconnections this can be improved. THD levels have increased slightly but remained within the allowed limits. Short- and long-term flicker (P<sub>st</sub>, P<sub>lt</sub>) reduced slightly.

The C<sub>2</sub>C project carried out by the a DSO in UK, Electricity North West (ENW), used enhanced automation technology, conventional operational practices, and commercial Demand Response contracts.

This may be a scenario like the Maltese network, but in view that the network contains many interconnections it is more difficult to control. Moreover, information coming from the substations is little and hence, estimation of loads per circuit branch may be required, with the same applying for voltage at each substation.

More research may be required to identify any methodologies implemented in the automation although it may be difficult to obtain from ENW.

Smart meters [25] may be used to obtain information from the LV network, thus having better visibility of the LV network behaviour during the day. Periodic readings of power flows, real, reactive, import and export can be obtained. Using this data, a load profile of the LV network can be determined, thus assessing thermal and operational limits of the network. From these, extra capacity can be located, thus additional PV systems may be accommodated. Furthermore, reverse power flows may be identified if they exist at some time during the day. This information will help the utility organisation to take the necessary action if required.

Voltage monitoring may also be achieved using smart meters and this may be used to optimise the network voltage throughout the day

However, it is not clear if the smart meters are only installed at the customers' end or additional specific meters are installed. One may consider having a smart meter installed in the substation and this will be used to retrieve periodically or in real time the data required.

This research [26] discusses the use of a Thevenin equivalent circuit to measure the grid impedance. It is proved that with PV penetration voltage variations exist both on the LV and on the MV networks. Thus, this Thevenin circuit will be used to assess accurately the penetration of PV systems into the grid.

The Thevenin equivalent circuit may be used as a reference when analysing similar networks.

## 2.6 Active Power Curtailment (APC)

Active Power Curtailment (APC) for PV systems connected to the LV system [27] is discussed to avoid overvoltage in LV feeders. The droop-based setting of each inverter is set against the voltage limits. Usually, this is a common setting for all inverters. Studies have shown that PV systems connected at the end of the feeder, experience more curtailment than those connected at the beginning of the feeder, which is near the substation. This means that customers having PV systems connected at the end of the feeder experienced more curtailments and hence less energy yields. This is not desirable from the customer's point of view, because he must maximise his investment. If settings are set such that APC is shared between all customers, then reduction in energy yield is shared as well.

However, to achieve this means that a utility organisation must have access to control the inverter of each PV system. This will imply that the utility organisation must face technical and commercial challenges. Reaching each inverter through various means of communication is a challenge and requires a substantial investment. At the same time, protocols must be defined prior to connecting the PV systems to the LV distribution network and this may reduce the number of commercial suppliers of PV systems, hence creating a monopoly market. Another problem could be how to communicate with the PV systems already installed which again will be a daunting task. If this is not achievable, then the network will remain with the same problem analysed in the aforementioned study.

## 2.7 Autonomous Voltage Control (AVC)

The report by Jiang Tianxiang et al. [28] discusses a trial test carried out with Electrical Energy Storage Systems (EES). A LV network was taken into consideration with some field trials. Then, computer models were created using IPSA2 and Python to enable further analyses on a larger scale. A 50kVA EES was used in this trial. This storage system was able to increase the voltage headroom by using control strategies for real power, reactive power, or both at the same time. This allowed more LCT loads (Low Carbon Technologies) such as Electric Vehicles (EV) and Air Source Heat Pump (ASHP), together with micro-generation such as PV to be added to the LV system. It was found that for high voltage, real power control was more effective while for low voltage control, reactive power control gave a better result. Considering this, it shows that for LV networks controlling the reactive power will be more beneficial since it will allow additional LCT loads and PV systems to be connected to the same LV feeder than if no control is applied.

The trial results can then be considered to apply for about 80% of the British distribution network.

It is mentioned that the secondary voltage is dependent on the primary voltage, meaning that controlling the MV voltage will affect positively or negatively the LV network and hence the RES penetration.



The studies carried out in [29] are similar to [28] but were based on different EES capacity, 100kVA. The outcome of these studies showed that reactive power from EES is more effective to control voltage than using the EES real power. This is dependent on the X/R Ratio of the upstream MV network. Although it was proved that the autonomous voltage control can allow more Low Carbon Technologies (LCT) to penetrate the network, this depends on the EES capacity.

UK Power Networks did a project study [30] by installing energy storage systems connected to an 11kV network. For this project two battery systems were installed, one rated 200kW and the other 600kW. By converting the stored energy to real power and absorbing or injecting reactive power into the grid it was shown that such energy storage systems will help the DNO to control feeders' peak loads, optimise feeder voltage and allow RES to generate their full output even when the network load is less than the generated capacity. The study was also aimed to evaluate the battery performance during charging and discharging. The batteries were switched from one feeder to another using a switching automation by using a RMU to connect two adjacent feeders.

However, it is not clear if other RMUs along the 11kV feeder were controlled from this ESS switching automation. In view that the storage system proved that such systems would help in the optimisation of a MV network, it is necessary to develop a scheme to incorporate all MV network switching devices installed in the feeders being evaluated. This will ensure that once more feeder configuration flexibility is achieved, it will maximise the benefits from the ESS. The generated energy is stored and dispatched at a more convenient time to meet the DNO requirements.

This merits a more detailed analysis of the existing network which may have more than one source or multiple feeders in the same area.

UK Power Networks [31], UKPN, is also observing the automation and flexibility of MV and LV networks by looking at readings taken from different feeder points and allowing to take decisions where to move the open point. This presentation does not give information how this may be achieved.

The visibility of a MV network is critical for a DSO. This UKPN presentation [32] is about having additional RTU installed in substations and storage of data read from different sites. This data

could be used for planning and operation of the network. Power flow visibility could be applied with the correct tools and equipment included in the SCADA system.

Control of voltage for a MV network, through SCADA, is necessary [33]. Information is brought from primary and secondary substation together with generator measurements. A function then calculates based on load flows the voltage at the customer connection and hence regulates the tap changer to the primary substation.

However, without a suitable number of measurements from various points on the MV network the algorithm will not work and its benefits are drastically reduced. Voltage control may not be optimum and hence a conservative approach may be taken.

## 2.8 Distributed Generation Photovoltaic (DGPV)

Distributed Generation Photovoltaic (DGPV) connected along a distribution feeder can be utilised to control the feeder voltage in addition to provide local energy generation. Usually, the control of voltage is done locally at each DGPV. A method to coordinate the voltage control at each substation or node [34] where DGPV are connected requires a good and robust communication system. Voltage regulation methods could be based on power factor, power together with power factor and reactive power control. The Q(U) method was proposed. This regulates the reactive power injection by each DGPV. If such regulation is installed in the MV substation and controlled locally, required feeder voltage regulation may not be achieved. This is because the voltage at the substation is usually within the accepted limits as controlled by the local DGPV. However, it will not take into account the PV penetration along the feeder which may create voltage levels along another part of the feeder which are beyond the accepted levels. If each PV generator implementing the Q(U) method is controlled by a system that monitors all DGPV and the feeder voltage at various locations, then it will be more effective. The voltage along an LV feeder tends to be higher when PVs are installed far away from the source substation. Hence, using the communication protocol standard, IEC 61850 provides a method to connect several DGPVs together. The IEC 61850-7-420 defines the models that can be used between DG plants, including PV systems, and the control system. GOOSE signals may be used to control voltage while measurements are obtained through the

standard defined logical nodes. Figure 2-1 shows a proposed telecommunications architecture.

What is not clear is how a PV system can inject or absorb reactive power through their inverters. This may be achievable for PV farms, but it may not be possible for residential PV systems. Secondly, using the IEC 61850 standard may be possible for large PV farms but not for residential PV systems. However, integrating substation automation where RES are present requires a good communication system base that can allow data exchange between the various RES.

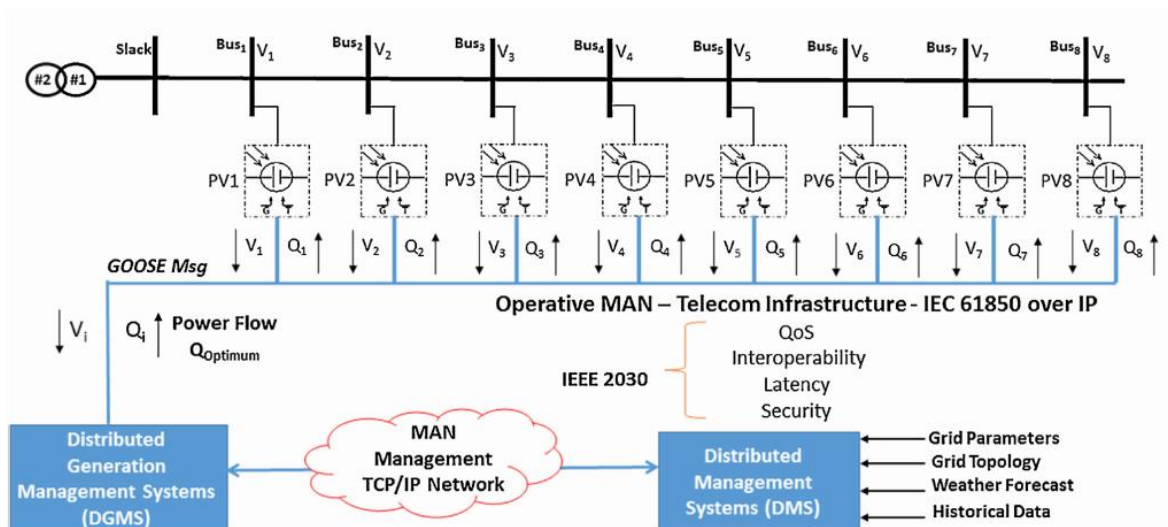

Figure 2-1 Telecommunications architecture for voltage regulation by multiple DGPV systems

## 2.9 Fault Tree analysis (FTA)

Fault tree analysis is a method used to assess systems and the reliability looking at events that may lead to failure or unwanted behaviour of the same system. The fault tree analysis was applied in space programmes and systems by NASA but later it was also applied in the manufacturing industry. In 2005 [35] it was used to assess power distribution network's reliability for Nuclear Power Plants. Later in 2014 [36] it was suggested to use the fault tree analysis for smart grids. The analysis concerned the reliability of a network that has renewable

sources connected and evaluated the supply failure either from the utility or from the RES themselves.

## 2.10 Selection of best locations

Installing automation devices requires analysis of the network and its performance [37]. Devices may be installed in locations where their effect on network performance may be minimal if no network analysis is carried out. However, if a good analysis is carried out then devices are installed in appropriate elected locations, network performance is increased and hence the yield is better compared to the investment done. Robert Reepe, in his article [37] takes into consideration the SAIDI and SAIFI indexes to measure the improvement if automation is installed. A simple example is given showing that without devices, the duration is longer than with devices installed. This means that customer minutes lost or CMI is longer. If financial terms are attributed to each minute lost, then one can estimate the cost of an interruption. This cost will be used to justify the capital investment required to install devices to achieve the required automation.

The T&D World Magazine article [37] is using SAIDI and SAIFI but not CAIDI. It is necessary to see the difference between the duration index for SAIDI and CAIDI and relate it to what is going in Europe and in UK.

The thesis by Sapienza [38] dealt with voltage control on MV and LV networks simulated using a Real Time Digital Simulator (RTDS). The traditional voltage regulation was discussed. The discussion was based on the Compound method, which is regulating the voltage at the receiving end rather than at the sending end. Traditionally, voltage controlled is done at the sending end, a voltage level is set together with the bandwidth change allowed. The compound method or as MR Relays state it as Line Drop Compensation (LDC), requires that the OHL or UG feeder data is known. The compound method or LDC is a method whereby the voltage control is done at the remote end of the feeder. This is done by knowing the feeder impedance and calculating the voltage drop along the feeder. However, when having multiple parallel feeders, it is then difficult to enter the correct parameters of the parallel feeders.

This study then investigates the issue with Distributed Generation (DG). Multiple DG active power injection in a network is not seen by the voltage regulator at the primary substation, hence voltage correction at the primary substation may not be correct. A method used is to have a profile for all nodes (substations), this from the DMS function. So, the set-point can be modified according to the daily profile, when DG is connected, the voltage at the sending end is corrected based on this profile. No further elaboration is given how this is implemented.

Two methods are then considered, UPG which is a threshold-based system where the generator power factor is set depending on the data being achieved and RQV a droop-based system, where the generator reactive power is set on the voltage at the point of interconnection.

The system studied depended on the voltage measurements from each node and the ability to control third party DG. However, if measurements are not available from the substations, then an alternative control strategy is required. At the same time, in household PV systems control for power factor and reactive power is not possible. Therefore, there may be an area where one can explore how voltage can be controlled by having the measurements at the sending end and the network parameters.

Impact of Voltage due to PV generation in Sweden. This report [39] investigates LV networks where PV generation is connected. Given that excessive PV generation will cause voltage rise in the connected network, and this may reach or exceed the maximum voltage limit allowed, it is necessary to investigate and recommend the maximum of PV generators that can be connected to that feeder. Limitations from network data resulted in analysis done only at busbar level and did not analyse the effects at feeder level. Load intervals of one hour were considered but it suggests considering the 15-minute interval. Unless such data from smart meters or substations recorders is not available in SCADA, then this cannot be achieved.

Various papers do a reference to the reliability test systems (RTS) and since RTS is a complex system to understand and to apply, the RBTS [40] was created for educational purposes and to serve as a platform for understanding how reliability models could be applied also to distribution systems. The RBTS has five load buses that can be analysed. This paper looked at two busbars as an example, each consists of a few 33/11kV primary substations and a number of 11kV feeders interconnected between them. The bus that has generation associated to its

network was selected because the other bus does not have any generation. Looking at both BUS types these are typical network configurations that are present in distribution systems. Analysis faults for cables, overhead lines and transformers considering failure rates, outage time, unavailability and energy not supplied were done. Indices such as SAIFI, SAIDI and CAIDI were considered. Given that this study focuses on such systems, the reliability methods used in it may be used as a platform in the research work being considered.

The authors in [41] look at algorithms considering the cost of interruption related to the type of customer, being residential, commercial, or industrial. The IEEE 34 and 123 bus systems were used to apply the algorithm being proposed. The network was divided in a number of clusters, hence grouping the number of substations. Each group was considered as one substation. This means that the potential points to allocate automated switches were seen as a group of substations. However, the fact that a feeder may consist of around 10 to 15 substations it is better to analyse the best location by looking at all substations and not as a group.

Distributed generation in an islanding mode was considered in the research done by the North China Power University [42]. The concept is to allow DG to operate in an island mode when there is a fault on the network by operating devices to segregate the network and based on load profiles and DG capacity, The network can be configured so that supply is restored to a number of customers. The method used to identify automated switching is based on known algorithms but applied to supply customers from distributed generation. However, this does not specify what type of DG is present and it is assumed that this refers to diesel, hydro, or wind generators. Looking at a network where the only distributed generation is by means of scattered PV panels on houses may be a challenge to maintain the load by these PV panels when they are operating in islanding mode. Considering the PV capacity at each substation in the proposed research is a novel contribution.

Various theories can be applied for optimal allocation of switches. This is highlighted in the study by B. Pang et al. [43]. A relationship between cases, probability and financial gain is explained. The RBTS-BUS6 was used as an example. Optimisation of the switching configuration was limited to a small range. It is said to speed up the search solution. Cost of equipment and cost of energy was considered. These will give an indicative value in the

proposed research, based on practical experience and actual costs, to improve the algorithms that may be used.

Outage cost, installation and maintenance cost were considered [44] using an optimisation method to reduce such costs. SAIDI, EENS and ECOST were obtained for each case being analysed. EENS stands for Expected Energy Not Supplied and ECOST stands for Expected Outage Cost. SAIDI, System Average Interruption Duration Index, is an index used to evaluate the performance of a network at the average interruption time of the whole distribution system. Customer Damage Function (CDF) was used and relates to the outage duration to cost associated with the interruption. Cost will vary according to the type of customer who had his supply interrupted. Customers may be residential, commercial, and industrial. Two cases were considered, without automated sectionalising switches and with sectionalising switches this time automated. Results showed that there was an improvement for SAIDI and ECOST.

A non-linear binary model, NLBP, was presented by Ferreira and Bretas in their paper [45] with the aim of minimising the SAIFI and SAIDI indices of a distribution feeder. SAIFI was the objective function to analyse an active distribution network. The authors were looking at distribution feeder models consisting of the main feeder, lateral sections together with an interconnecting point with adjacent feeders. The model was modified to obtain the SAIFI and SAIDI indices. Comparison of the represented model with other models described in other papers was carried out. Results showed an improvement in SAIFI and SAIDI using the NLBP model. The method approach for evaluating a feeder using the NLBP model may be considered for CAIDI indices.

Optimal planning of distribution networks that have distributed generation (DG) and distributed storage systems (DSS) connected must be operated as efficiently as possible [46]. This study looks at a cluster of substations where each cluster may have a DG, a DSS or both. Secondly, the contributed solution was to determine the location and size of distributed energy resources (DER). Models were tested using the IEEE-34 bus system from which various scenarios were considered. Wind and PV DG were considered at two distinct locations. Although clusters of substations are being supplied by a DG, it is not clear how this can be achieved especially when PV DG is being considered.

The probability of malfunctions in switches [47] was considered to find the optimal switches placement in distribution networks considered the probability of malfunctions in switches [47]. In real networks, switches do not always perform when required and malfunctions could occur, this like in all other equipment. The malfunction will have an impact on the restoration time and hence considering this in the optimisation method should ensure having the correct selection of substations for installing the remote-control switches. Several optimisation techniques are available. This study [48] proposes the differential search algorithm. This was proposed after comparing with the Particle Swarm Optimisation (PSO), Differential Evolutionary algorithm (DE), Genetic Algorithm (GA), Ant Colony Optimisation (ACO) and the Gravitational Search Algorithm (GSA). Power system operations are based on operational parameters of the distribution network such as voltages, current and power flows. Asset condition is a parameter that is not usually considered [49]. Including the assets condition in optimisation processes will influence the switches placement and the distribution network operation performance.

## 2.11 The Maltese power system

The limitation for PV systems connections depends on the LV and MV network characteristics. Depending on the network configuration, cable or overhead line capacity and voltage limits, PV systems can be or cannot be connected. Furthermore, if they are connected, the need may arise to curtail the power delivered to the grid. Figure 2-2, Figure 2-3 and Figure 2-4, [19] show typical classical MV networks and their voltage profiles for low load and peak loads, assuming no voltage regulation is active. Figure 2-5 [19] shows a typical MV and LV power system. The voltage levels shown are typical and for the Maltese Power System these are 11kV and 400V.

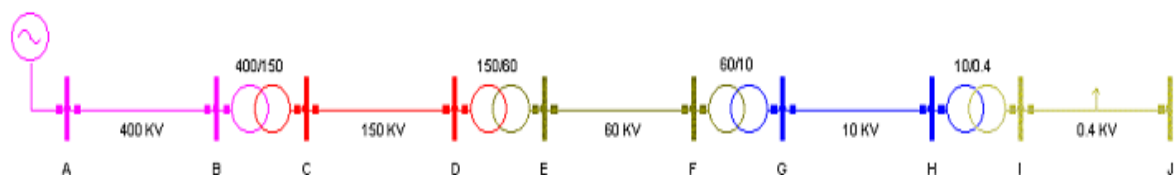

Figure 2-2. Classical power system



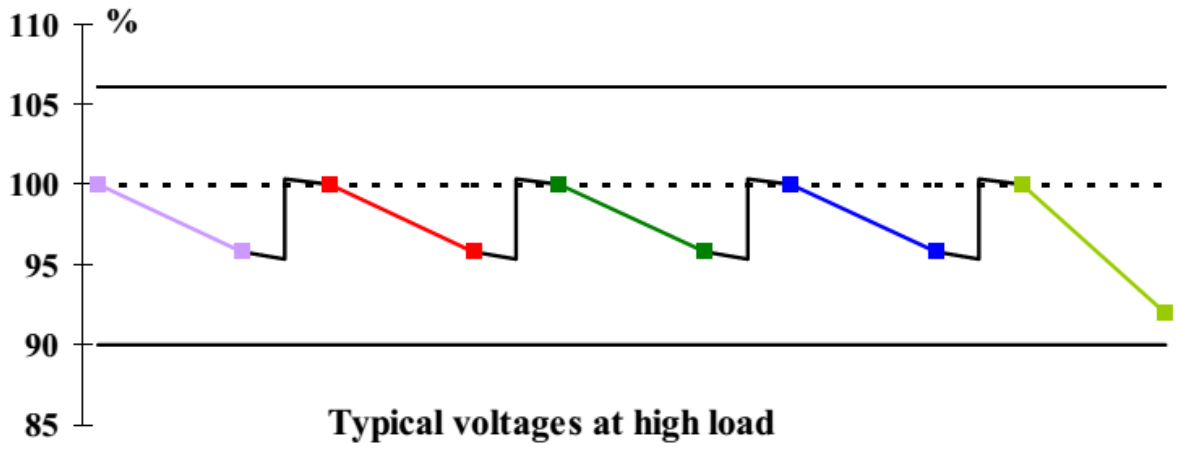

Figure 2-3. Typical voltages at high load

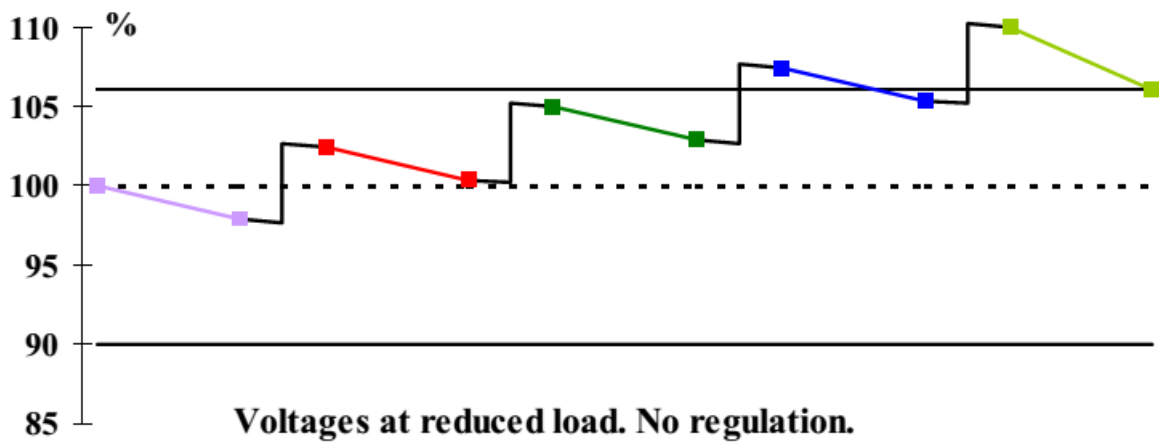

Figure 2-4. Typical voltages at low load and if no transformer voltage regulation is applied

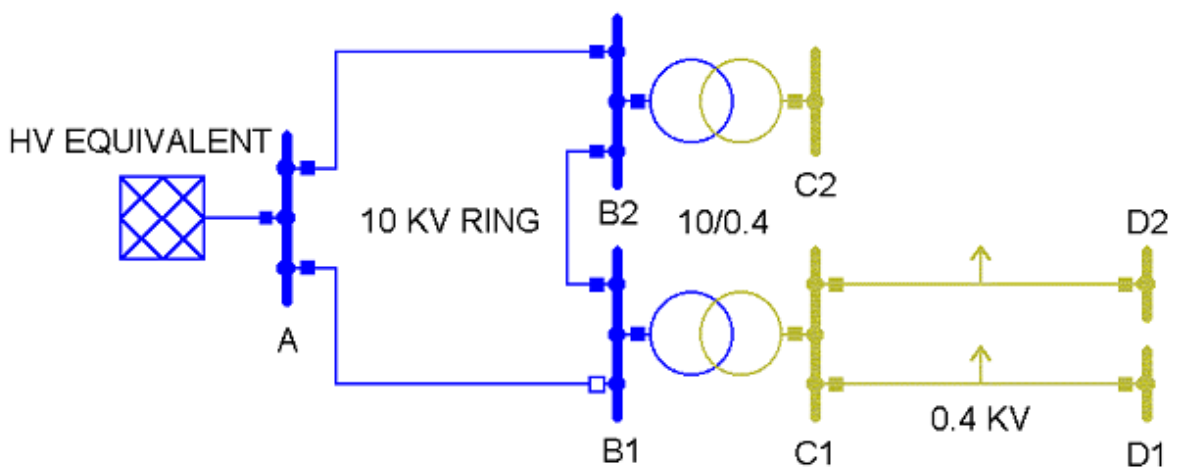

Figure 2-5. Typical MV and LV network

The Maltese power network is predominantly made up of underground cables, implying that when the network is lightly loaded, the receiving end MV/LV substations may have a higher voltage than that at the sending end of the primary substations. Figure 2-6 is part of the Maltese 11kV Power system showing only two 11kV feeders from two different 33/11kV primary substations, both fed from a 132/33kV substation. For the sake of simplicity and to obtain an initial understanding, the number of 11/0.4kV substations is reduced. However, the type and lengths of the underground 11kV cables are the same lengths as those of the actual two feeders. These were simulated, using ERACS power systems analysis software, to show voltage variations with and without PV generation. The initial renewable schemes were for residential PV Systems. Grants were given so that the majority of households could install a PV system on their rooftop. Along the years more schemes were introduced to install both residential and larger PV systems. Figure 2-7 shows the location of different power ratings for PV systems installed by 2016.

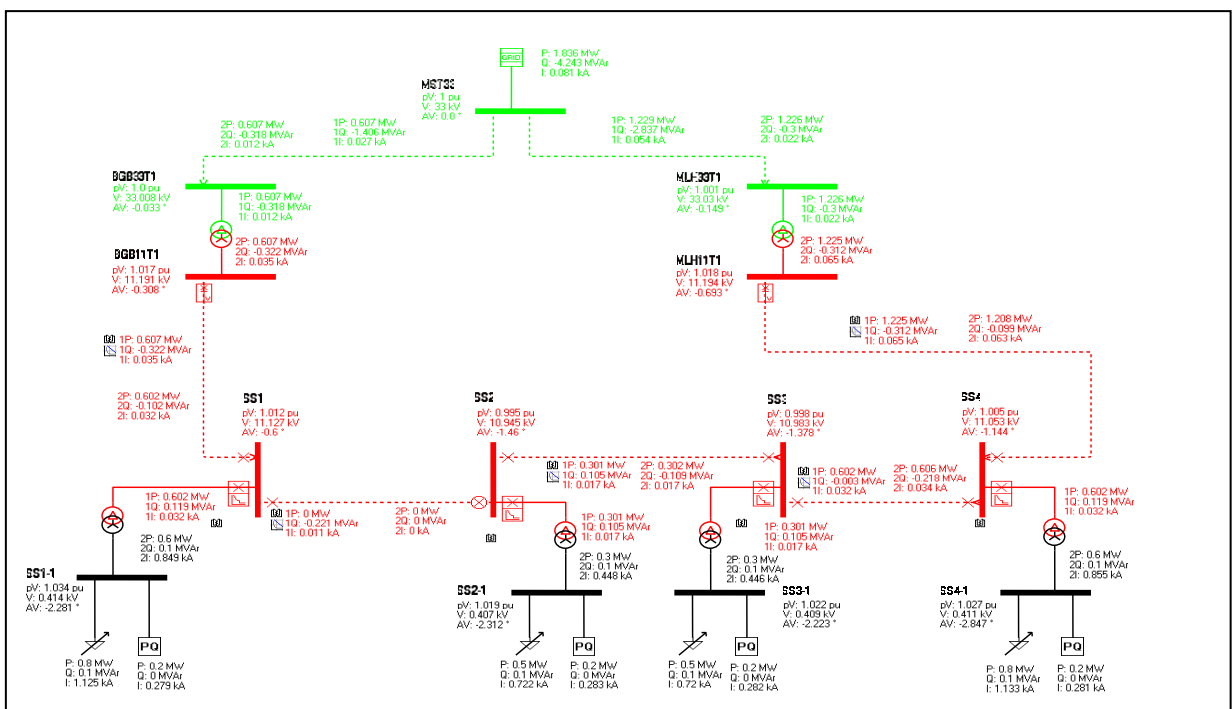

Figure 2-6. Typical 11kV network connecting two primary substations

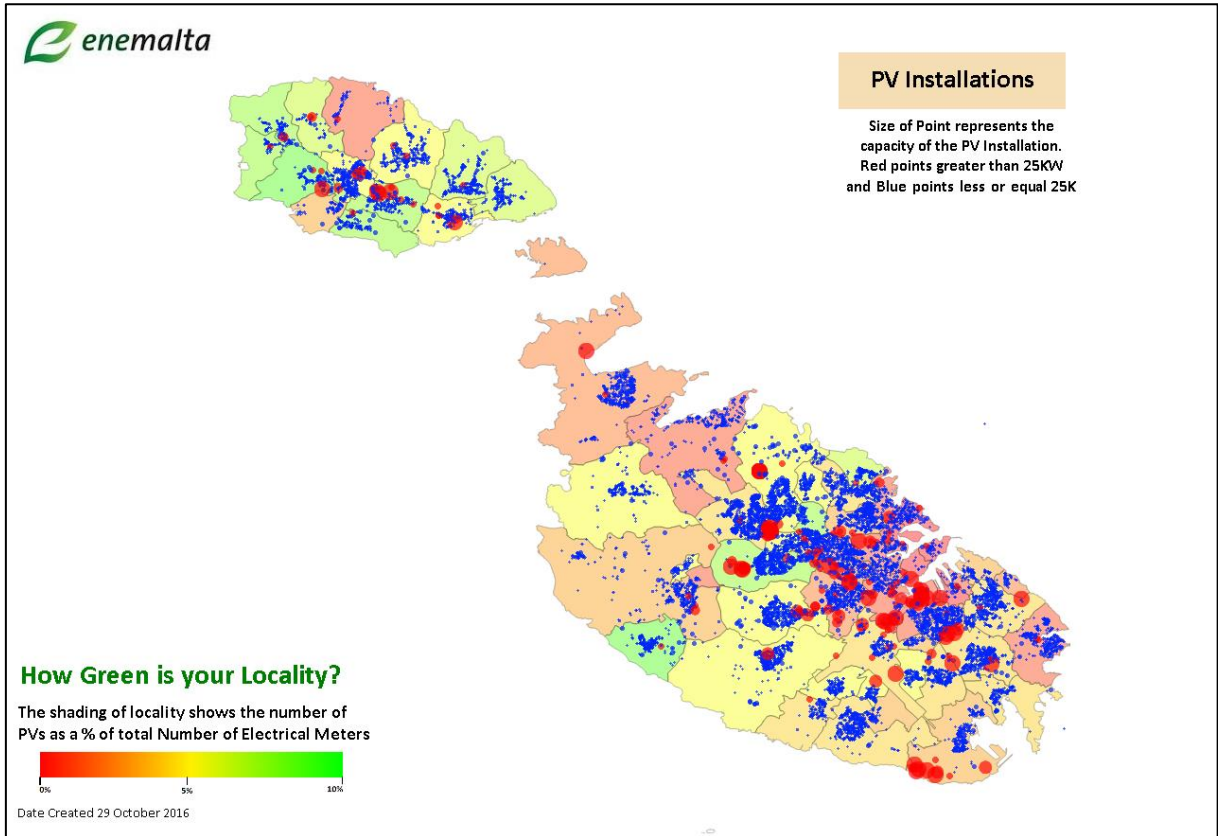

Figure 2-7. PV Installations in Malta. Courtesy of Enemalta plc®

## 2.12 Summary

The reviewed research studied MV and LV networks. Data that may be available from household smart meters and other data available at the MV/LV substations can be used to control the voltage rise on the MV or LV networks and as well avoid possible curtailment to PV systems. Other research studied the best possible substations that can be remotely operated.

The aim is to optimise MV networks by means of:

- 1) Manual switching
- 2) Remote switching, but manually controlled from the network control room
- 3) Automated switching, where human intervention is minimal
- 4) Considering the use of Soft Open Points
- 5) Consider using a tool to identify the best substation locations to install actuators and RTUs.

These can be summarised as follows:

1. Manual switching is normally achieved by sending a site engineer to move the NOP to another substation, but this will be time consuming, and reaction is late to when it is required. The NOP is determined following a network study based on real time data.
2. Remote switching is carried out as highlighted under Point (1) above but the need to send out engineers is not required.
3. When data is retrieved from a number of substations, an automation process can be initiated so that NOP is moved according to the analysis done. Voltage information retrieved from individual substations can also be used to automatically control the tap changers in Distribution substations, i.e., 33/11kV transformers. Usually, Automatic Voltage Relays measure the transformers secondary voltage and correct the tapping for the set reference voltage. In this case, both the transformer terminal voltage and the voltage reading from the substations are fed into a control system so that the transformer tapings are set to correct the voltage at the receiving end without

compromising the busbar voltage at the primary substation. When voltage information is not retrieved from individual substations, the estimation of voltage is required. This need to be done at the primary substation where the tap change control is possible. Measuring the voltage and the load current and by knowing the state of the network being fed, an algorithm may be obtained to estimate the voltage at each secondary distribution substation, i.e., at 11kV. Hence tap change is initiated to raise or lower voltage at the source, hence correcting voltage at each 11kV substations. Having substation equipped with actuators and RTU, the same control algorithm may decide to move and NOP to achieve better voltage level and allow more PV generation penetration on the same network, this without reducing the PV systems outputs.

4. Soft Open Points give the additional advantage where power flow is allowed to flow from one circuit to another, keeping the voltage level within the set parameters and at the same time controlling the fault levels at the same level as if the network was being operated with NOP. The latter will ensure that change in protection settings is not required, and equipment short circuit ratings are not compromised.
  
5. An analysis tool to assist engineers to identify substation locations where actuators and RTUs can be installed. Having a large network, as usually has DSOs, means a lot of investment is required. In private power distribution networks, the number of substations is few, for example not more than ten substations. So, the cost to automate all substations is achievable and it is easier to obtain financial approval. The cost may be circa €150,000. On the other hand, utility distribution networks are much larger, and the number of substations will run into hundreds or thousands deepening if it is a village, town, or city. Thus, investment will run into millions. Typical cost of automating circa one thousand substations may be in the region of €15M. This implies a significant investment which must be done over a number of years both for financial reasons and due to installation limitations. It is difficult to manage a substantial number of substations installations since one must have enough technical personnel to do the works and to coordinate with customers' interruptions to eventually install and to carry out the necessary testing. This means that an analysis tool to identify the best locations and rank them in order of priority will help planning engineers to

maximise the return on investments by reducing the customers' minutes lost and at the same time, enabling the network to become more flexible in its configuration.

## Chapter 3 - Substations ranking for actuator placing

This chapter explains from where the initial idea originated. The following explains the initial thoughts and results obtained following the development of empirical formulas based on work experience and practical thoughts.

The existing 11kV network was not yet equipped with necessary actuators and RTUs to automate it. It was necessary to identify those substations where to install such equipment. The best design and 'nice to have' is that all substations are equipped and automated. However, this requires a huge investment running into millions of Euros. This investment is to be spread on several years. Hence apart from the financial limitations, other limitations exist such as workforce to carry out the installations, network constrains to switch off substations, etc. Therefore, it was required to locate those substations to be equipped with equipment in the first year and subsequently, in the following years. Thus, a method was required to analyse substations, feeders, and other attributes to obtain a ranking location system and, at the same time, to maximise the return on investment done each year.

### 3.1 Methodology

The analysis will consider:

1. Number of connected customers per substation
2. Type of customers, industrial, commercial or domestic
3. Access to the substation
4. Travelling duration and parking
5. Switchgear operational restrictions
6. Substation feeders' layout
7. Identify an 11kV network and obtain data
8. Mathematical formulation
9. Analyse a typical network

### 3.1.1 Connected customers per substation

Each substation will supply several customers and these are defined by the number of energy meters being supplied from that substation. The number could vary from only one to hundreds and, in some case, even running into thousands. A hotel or factory may have a dedicated substation, hence there will be only one energy meter. Another substation may have several LV feeders where every LV feeder may supply a dedicated customer or a number of customers.

### 3.1.2 Type of customers

Substations do supply different type of customers, being residential, commercial or industrial. The need for every customer type may vary. Therefore, it is necessary to look at the impact of power supply interruption to such customers. Hence their weighting will influence the priority list of substations that are to be considered for the required automation. Weighting may vary between different Distribution Network Operators and this depends on how they perceive the importance of their customers based on past experiences, customer expectations and regional requirements.

### 3.1.3 Access to the substation

Access to substations sometimes may be problematic. Traditional substations are usually located at ground floor level with direct street access. However, in view that property value has increased significantly and a substation property at ground floor level is considered a lost value (equivalent to a sunk cost), property developers are no longer willing to offer such spaces for substations at ground floor level but, in most cases, they offer a space in which is underground in the basement. Other substations may be located on private property grounds and behind gates. This implies that, to access the substation, it may take considerable time



and one must wait for someone to provide the necessary access. Other substations may need to be accessed through cat ladders, trap doors, etc. This will take a considerable amount of time which will inevitably prolong the restoration time.

#### 3.1.4 Travelling duration and parking considerations

Some substations are in areas which are difficult to reach. This could be due to traffic problems or difficulty to find parking facilities in the nearby vicinity. Such substations are usually in commercial areas and in density populated areas where parking is extremely limited. Moreover, such localities, traffic jam are usually the order of the day and hence arriving on site will take time.

#### 3.1.5 Switchgear operational restrictions

There are substations that are equipped with a switchgear that has been identified as risky to operate manually. This could be due to age, deteriorated electrical insulation, mechanical faults, history of failure or its design does not meet the IAC criteria.

#### 3.1.6 Substation feeder's layout

The switchgear layout in a substation varies depending on the network requirement. A typical substation consists of an RMU and an 11/0.4kV transformer. The RMU will have two-line switches and a circuit breaker for the transformer. One of the switches will be connected to the feed-in cable and the other switch will be connected to the outgoing cable. This means that there will be one outgoing switch and the local CB that can be remotely controlled. This means that either downstream load or the local load can be restored through these devices. At the same time, a fault downstream can also be isolated through the automated switches. For example, an RMU has one source and one output together with a local transformer. Four



From the DNO network database, the information for all substations was extracted and converted to an excel sheet to be able to analyse the data. Any form of ranking values was added so that the final ranking of substations is obtained.

### 3.1.8 Mathematical formulation

Mathematical equations were developed to analyse and rank the substations that may be given priority for installing actuators and RTUs. These equations can be further developed following some tests done on part of a network.

The equations are:

Substation points,  $SSP$ , is given by:

$$SSP = \left[ \sum_{n=1}^k FC_n \right] \cdot OUTF^{(FNOP+1)} \quad (1)$$

Where

$FC_n$  Is the feeder number in a substation, numbered clockwise from the incoming feeder, 1<sup>st</sup> feeder is  $FC_1$ , and 2<sup>nd</sup> feeder is  $FC_2$ , etc. For each feeder, the number of connected customers need to be inputted.

$OUTF$  The number of outgoing feeders from a substation including a Normally Open Point.

$FNOP$  Normally Open Points (NOP) in the substation.

Total feeder points, TFP is given by:

$$TFP = \sum FN_{DC} = \sum_{n=1}^k SSP_n \quad (2)$$

Where

$FN_{DC}$  Feeder number from the distribution centre (primary substation).

Substation points considering the substation importance value, SSV, is given by

$$SSV = (SSP \times SSI) + FNOP \quad (3)$$

Where

$SSI$  is the substation importance ranking value based on the substation importance as given in Table 3-1.

Total feeder points considering the substation importance, TFPI, are given by:

$$TFPI = \sum_{n=1}^k SSV_n \quad (4)$$

Substation Importance (SSI)	Description
1	None
2	Parking – difficult to find parking near substation
3	Traffic – difficult to reach substation due to traffic congestions during most of the day
4	Door Access – substation door access is not in a public area, thus the technical staff need to access the substation through third party properties and this will cause a delay during restoration of supply phase
5	Restriction of Operation – high safety risk to operate switchgear in substation
6	Important load – load could be a hotel, hospital, etc

*Table 3-1. Substation Importance ranking value*

### 3.2 Example for an 11kV network

A typical meshed network is given in Figure 3-2. This shows three feeders from a primary substation, each feeder having several secondary substations.

Feeder No 1, circuit layout, is shown in Figure 3-3. This shows in greater detail how substations are looped from one substation to another to form a radial circuit.

The single-line diagram for substation No. 11 is given in Figure 3-4, showing in detail how the switchgear configuration is set to supply the local transformer and the outgoing feeders.

The circle represents a substation and in the circle the name of the substation is shown, for example SS 02. The number, under the substation's name indicates the number of customers that are being supplied energy from that substation. Based on this typical network, the feeder points were calculated. At each substation, the feeders are numbered. Numbering is given in a clockwise direction starting from the first feeder, next to the incoming feeder, and numbered '1'.

For each of the substation outgoing feeders, the number of customers connected downstream are noted. This means that if the feeder trips, these will be the number of connected customers that will be affected negatively by the fault. The substation points are calculated, and the points will give a priority ranking for each substation indicating where to install automation.

Following the substation ranking, feeder ranking is required. By looking at multiple feeders, it is necessary to identify which feeders can be prioritised for the required automation investment. The initial calculations did not consider the importance of the substation, therefore further calculations were done to include the substation importance.

The results for the substations ranking are given in Table 3-2, while that for the feeders ranking is given in Table 3-3.

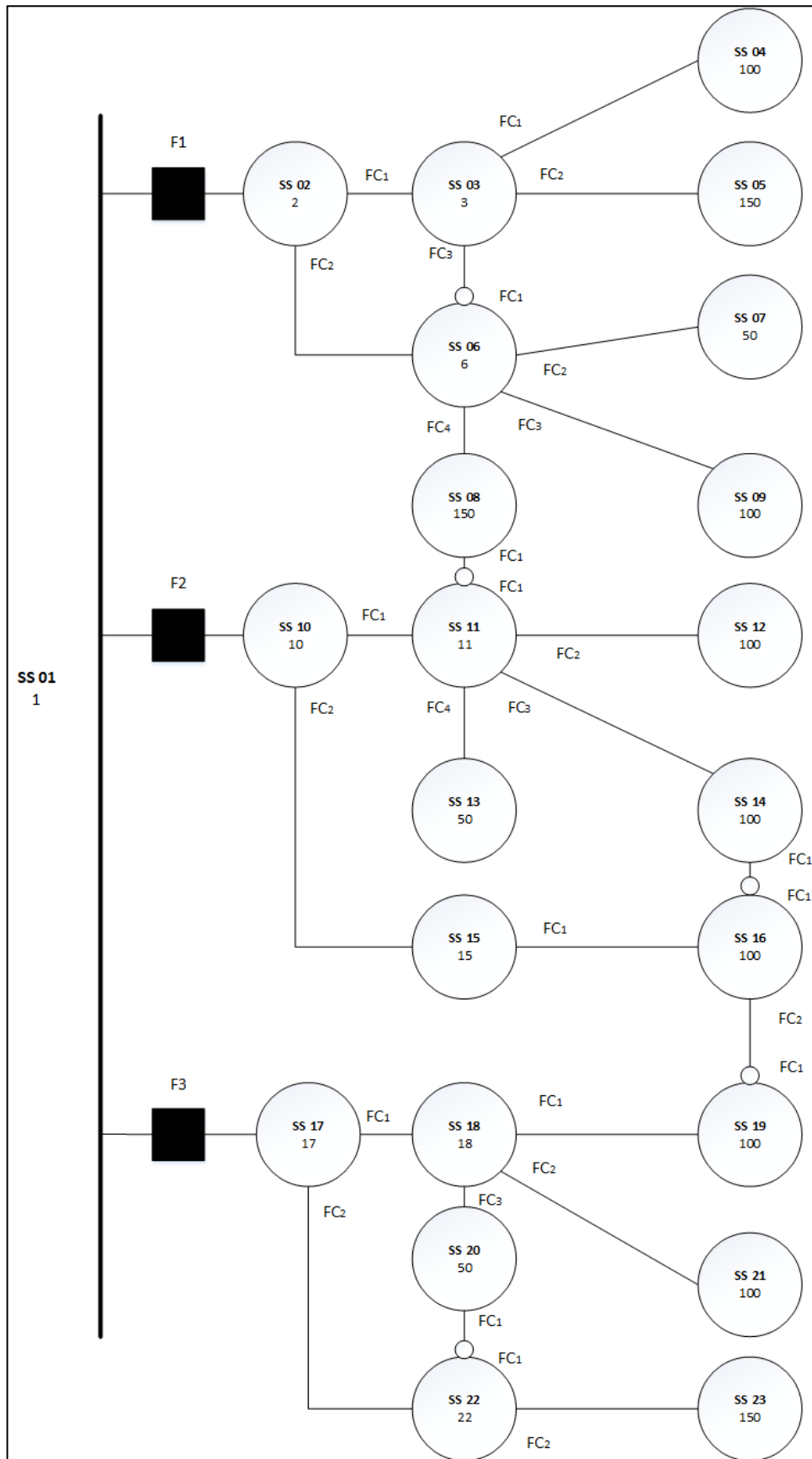

Figure 3-2. An 11kV meshed network model with Normal Open Points

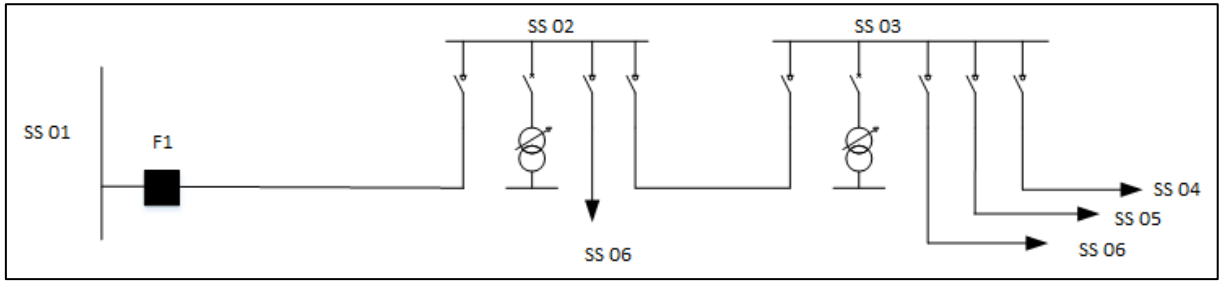

Figure 3-3. Circuit layout for Feeder No 1

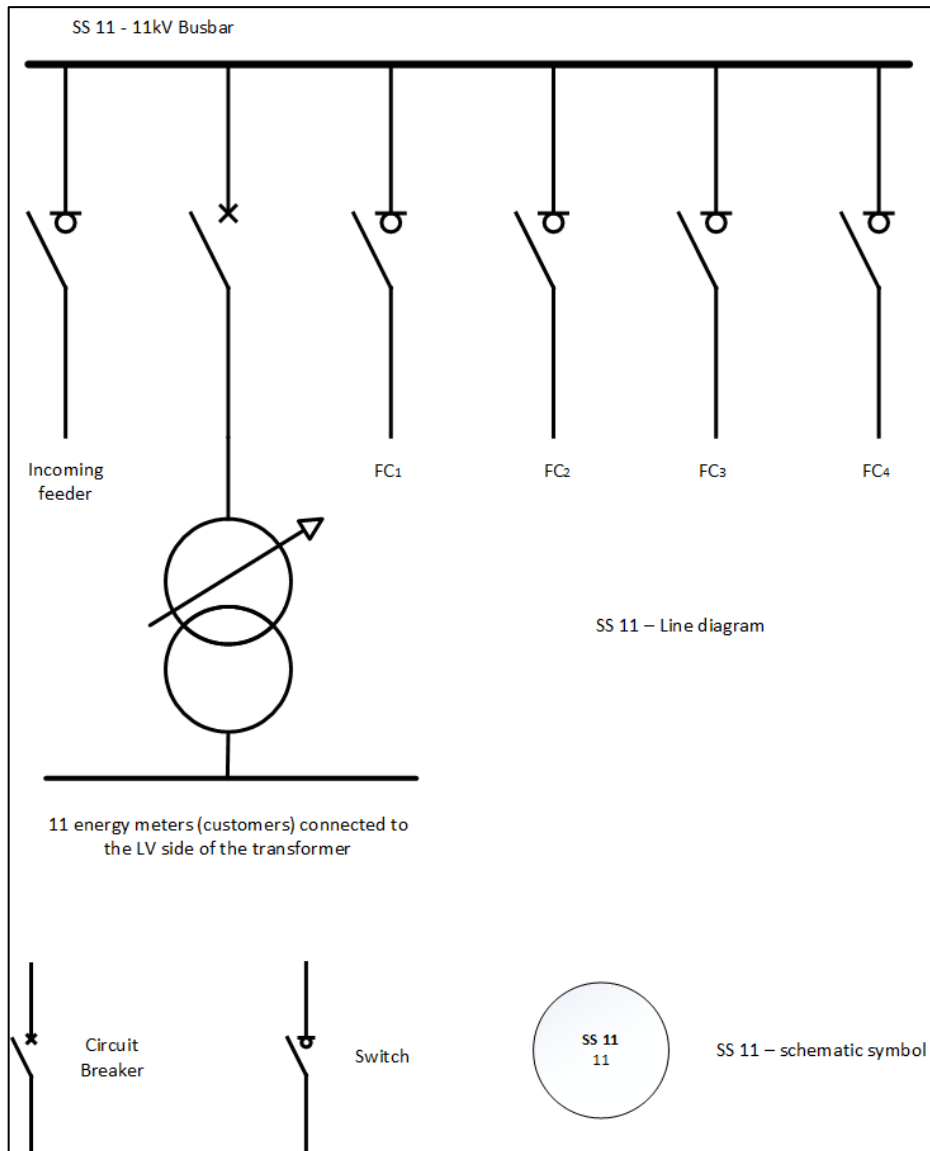

Figure 3-4. Single line diagram for substation No 11



From the results obtained the following data table was compiled:

Table 3-2. Substation points value results

Feeder No	Substation name	Outgoing feeders	Customers for every outgoing feed				No of NOPs	Importance	Points	
			$FN_{DC}$	$OUTF$	$FC_1$	$FC_2$			$FC_3$	$FC_4$
1	SS 02	2	253	306	0	0	0	3	1118	3354
1	SS 03	3	100	150	0	0	0	5	750	3750
1	SS 04	0	0	0	0	0	0	2	0	0
1	SS 05	0	0	0	0	0	0	3	0	0
1	SS 06	4	0	50	100	150	1	4	4800	19201
1	SS 07	0	0	0	0	0	0	4	0	0
1	SS 08	1	0	0	0	0	0	2	0	0
1	SS 09	0	0	0	0	0	0	6	0	0
2	SS 10	2	261	115	0	0	0	2	752	1504
2	SS 11	4	0	100	100	50	1	2	4000	8001
2	SS 12	0	0	0	0	0	0	6	0	0
2	SS 13	0	0	0	0	0	0	6	0	0
2	SS 14	1	0	0	0	0	0	2	0	0
2	SS 15	1	100	0	0	0	0	4	100	400
2	SS 16	2	0	0	0	0	1	6	0	1
3	SS 17	2	268	172	0	0	0	4	880	3520
3	SS 18	3	100	100	50	0	0	1	750	750
3	SS 19	1	0	0	0	0	1	6	0	1
3	SS 20	1	0	0	0	0	0	6	0	0
3	SS 21	0	0	0	0	0	0	6	0	0
3	SS 22	2	150	0	0	0	1	4	600	2401
3	SS 23	0	0	0	0	0	0	1	0	0

Table 3-3. Feeder points considering substation points only and including substation importance

Feeder No	Feeder points SSP	Feeder points SSV
1	6668	26305
2	4852	9906
3	2230	6672

Analysing the results calculated and tabulated in Table 3-2 and Table 3-3 respectively, it can be concluded that:

- a) Substation automation priority ranking is SS 06 and then followed by SS 11, and so on.
- b) Feeder automation priority ranking is Feeder1, then followed by Feeder 2 and then Feeder 3.

### 3.3 Case study for the Bugibba 11kV network

The mathematical equations developed and used in the example given above, were applied to the Bugibba 11kV network. Figure 3-5 shows the 11kV network for Bugibba area, based on the schematic drawing updated in October 2016. Bugibba Distribution Centre is the primary substation that supplies all substations in this area. Each substation, shown as a circle, is usually named after the village and street name, with some dedicated ones named for the hotel name. For each substation, the transformer rating is given in kVA and the type of switchgear is indicated with letters. ‘E’ stands for a circuit breaker equipped with IDMT protection relay, ‘G’ for a switch, ‘T,’ ‘R,’ ‘S’ and ‘H’ are circuit breakers or switches equipped with either an HV fuse or a LV Time Limit Fuse. ‘P’ indicates that an Earth Fault Indicator is installed. ‘M’ means that an HV metering Unit is installed.



Table 3-4. Substations Location ranking-2016-Data

Feeder No	Substation name	Outgoing feeders	Customers for every outgoing feed			No of NOPS	Importance	Points	
			$FC_1$	$FC_2$	$FC_3$			$FNOP$	$SSI$
$FN_{DC}$		$OUTF$	$FC_1$	$FC_2$	$FC_3$	$FNOP$	$SSI$	$SSP$	$SSV$
1	Bugibba Arznell	2	484	2159	0	0	1	5286	5286
4	Bugibba St. Anthony	1	0	0	0	0	3	0	0
3	Bugibba Sewage	1	1375	0	0	0	5	1375	6875
1256	Bugibba San Xmun	1	950	0	0	0	2	950	1900
1239	St. Paul's Bay Dawret il-Gzejjer	1	1841	0	0	0	3	1841	5523
7	St. Paul's Bay Silver Line Aparts. Tower Road	1	0	0	0	1	4	0	1
1087	St. Paul's Bay San Giraldu	1	301	0	0	0	4	301	1204
6	St. Paul's Bay Gillieru Hotel	1	2157	0	0	0	2	2157	4314
12	Qawra Topaz Aparthotel	1	219	2	0	0	6	221	1326
11	Bugibba Stanton Court	1	1	0	0	0	2	1	2
977	Bugibba Karanne	1	2	0	0	0	2	2	4
16	Qawra Point	2	28	0	0	1	2	112	225
1100	Qawra Port Ruman	1	1042	0	0	0	4	1042	4168
17	Qawra Santana Hotel	1	733	0	0	0	6	733	4398
1393	Qawra Turisti (Triton Mansions)	1	606	0	0	0	4	606	2424
1367	Qawra Nawciera	1	1381	0	0	0	1	1381	1381
15	Qawra Palace Hotel	1	0	0	0	1	6	0	1
18	Qawra Soreda	1	1367	0	0	0	6	1367	8202
1094	Qawra Bellavista	1	1482	0	0	0	6	1482	8892
1626	Qawra Trunciera (Aquarium)	1	604	0	0	0	4	604	2416
1083	Qawra Frejgatina	2	1187	103	0	0	1	2580	2580
22	Qawra Salina Park	2	237	0	0	1	1	948	949
23	Qawra Salina Wharf	1	87	0	0	0	1	87	87
1617	Salina Katakombi (Salina Mansions)	1	0	0	0	1	1	0	1
20	Qawra Riza Aparthotel	1	2	0	0	0	6	2	12
27	Bugibba Triq it-Turisti	1	325	0	0	0	1	325	325
24	Bugibba Holiday Complex	2	1427	0	0	1	6	5708	34249
1325	Qawra Qawra Rd. (Springfield)	1	2049	0	0	0	1	2049	2049
25	Bugibba New Dolmen Hotel Tr. 1	2	0	2	0	1	6	8	49
1076	Bugibba Islet Promenade	1	1255	0	0	0	4	1255	5020
26	Bugibba New Dolmen Hotel Tr. 2	0	0	0	0	1	6	0	1
923	Burmarrad San Pawl Milqi	2	0	3198	0	1	6	12792	76753
45	Burmarrad Price Club	1	526	0	0	0	1	526	526
46	Burmarrad Village Substation	1	569	0	0	0	1	569	569
942	Qawra Church	1	0	0	0	0	1	0	0
9	Bugibba Aristarku Tr. 1	3	0	1413	588	1	1	18009	18010
5	Bugibba St. Peter's Court	3	0	560	244	1	1	7236	7237
10	Bugibba Sqaq Berah	1	836	0	0	0	3	836	2508

The first columns give the substation ID, the feeder number to which the substation is connected upstream, the locality, the substation name, the transformer rating, whether the transformer is energised and the number of connected energy meters. This information is obtained from the DNO database. Other columns were added. OUTF is to show how many outgoing feeders there are from that substation. FC1 to FC3 gives the number of energy meters connected to that feeder up the normally open point. These are obtained from those substations downstream that are being supplied from this feeder. FNOP indicates if there is a NOP in the substation being considered. SSP, SSI and SSV are the results obtained when the equations are applied. FNOP+n is used to give weighting to a normal open point. The analyses considered n equal to 1, 2 and 3.

### 3.3.1 Ranking without substation importance

The ranking was obtained by considering the substation points, SSP, and the feeder points, TFP for FNOP+1. The ranking is done for the feeders, Table 3-5 and then for each feeder, substations are ranked accordingly as shown in Table 3-6. For each primary substation feeder, FNDC, the total feeder points were calculated and ranked accordingly. For each feeder, the substation points were calculated to rank the substations in each feeder. Hence priority lists are obtained for the feeders and for the substations.

The same calculations were done but giving more weight to the NOP. Results are given in Table 3-7 and Table 3-8.

*Table 3-5. Feeder ranking - FNOP+1*

Feeder No	Feeder points
7	39859
9	19684
6	13887
1	11910
5	9345
3	7327
4	3617
161	1502
2	224

Table 3-6. Substation ranking for each feeder – FNOP+1

FNOP+1				
Feeder	Feeder Points	Substation	Substation Points	Customers
7	39859	Aristarku Tr. 1	18009	741
		Triq il-Pijunieri	8336	444
		St. Peter`s Court	7236	609
		Bugibba D.C. Local	4612	480
		Sqaq Berah	836	590
		Sunflower Hotel	828	8
		Triq ic-Cern	2	558
		Aristarku Tr. 2	0	588
		Holiday Complex No. 2	0	2
		St. Peter`s Court Tr. 2	0	244
		Church	0	828
9	19684	St. Georges	4488	1093
		Erba` Mwiezeb	3725	333
		Gov. Housing Estate (Qarbuni)	3537	188
		Emmanuel Pinto	3337	200
		Drainage Pumping Station	2244	0
		Near School	1136	1108
		Telephone Exchange	620	262
		Stella Maris	417	719
		St. Georges	180	29
		Zebbiegh Road T/C	0	38
		Villa Strickland T/C	0	52
		Hill Top Village T/C	0	29
		Villa Ivy T/C	0	7
6	13887	San Pawl Milqi	12792	526
		Burmarrad Substation	569	36
		Price Club	526	43
		Burmarrad T/C	0	56
		Bidnija ` B ` T/C	0	12
		Bidnija ` A ` T/C	0	145
1	11910	Arznell	5286	1340
		Gillieru Hotel	2157	2
		Dawret il-Gzejjer	1841	316

		Sewage	1375	466
		San Xmun	950	425
		San Giraldu	301	183
		St. Anthony	0	950
		Silver Line Aparts. Tower Road	0	301
5	9345	Holiday Complex	5708	622
		Qawra Rd. (Springfield)	2049	329
		Islet Promenade	1255	172
		Triq it-Turisti	325	930
		New Dolmen Hotel Tr. 1	8	323
		New Dolmen Hotel Tr. 2	0	2
3	7327	Bellavista	1482	2
		Nawciera	1381	101
		Soreda	1367	14
		Port Ruman	1042	325
		Santana Hotel	733	309
		Turisti (Triton Mansions)	606	127
		Trunciera (Aquarium)	604	2
		Point	112	576
		Palace Hotel	0	28
4	3617	Frejgatina	2580	1308
		Salina Park	948	950
		Salina Wharf	87	150
		Riza Aparthotel	2	85
		Suncrest Hotel	0	2
		Katakombi (Salina Mansions)	0	103
161	1502	Manor Investments	998	216
		Triq Ghawdex	499	0
		Canifore	3	3
		Costa San Antonio	1	0
		Gallina Triq il-Bahhara	1	496
		Topaz Aparthotel	221	249
2	224	Karanne	2	9
		Stanton Court	1	209
		Crown Hotel	0	1
		Topaz Aparthotel Tr. 2	0	2

Table 3-7. Feeder ranking - FNOP+3

Feeder No	Feeder points
7	266827
6	52263
9	35548
1	27768
5	26493
4	14201
3	7663
161	4496
2	224

Table 3-8. Substation ranking for each feeder – FNOP+3

Feeder	Feeder Points	Substation	Substation Points	Customers
7	266827	Aristarku Tr. 1	162081	741
		St. Peter`s Court	65124	609
		Triq il-Pijunieri	33344	444
		Bugibba D.C. Local	4612	480
		Sqaq Berah	836	590
		Sunflower Hotel	828	8
		Triq ic-Cern	2	558
		Aristarku Tr. 2	0	588
		Holiday Complex No. 2	0	2
		St. Peter`s Court Tr. 2	0	244
		Church	0	828
6	52263	San Pawl Milqi	51168	526
		Burmarrad Substation	569	36
		Price Club	526	43
		Burmarrad T/C	0	56
		Bidnija ` B ` T/C	0	12
		Bidnija ` A ` T/C	0	145
9	35548	St. Georges	17952	1093
		Erba` Mwiezeb	3725	333
		Gov. Housing Estate (Qarbuni)	3537	188
		Emmanuel Pinto	3337	200
		Telephone Exchange	2480	262



		Drainage Pumping Station	2244	0
		Near School	1136	1108
		St. Georges	720	29
		Stella Maris	417	719
		Zebbiegh Road T/C	0	38
		Villa Strickland T/C	0	52
		Hill Top Village T/C	0	29
		Villa Ivy T/C	0	7
1	27768	Arznell	21144	1340
		Gillieru Hotel	2157	2
		Dawret il-Gzejjer	1841	316
		Sewage	1375	466
		San Xmun	950	425
		San Giraldu	301	183
		St. Anthony	0	950
		Silver Line Aparts. Tower Road	0	301
5	26493	Holiday Complex	22832	622
		Qawra Rd. (Springfield)	2049	329
		Islet Promenade	1255	172
		Triq it-Turisti	325	930
		New Dolmen Hotel Tr. 1	32	323
		New Dolmen Hotel Tr. 2	0	2
4	14201	Frejgatina	10320	1308
		Salina Park	3792	950
		Salina Wharf	87	150
		Riza Aparthotel	2	85
		Suncrest Hotel	0	2
		Katakombi (Salina Mansions)	0	103
3	7663	Bellavista	1482	2
		Nawciera	1381	101
		Soreda	1367	14
		Port Ruman	1042	325
		Santana Hotel	733	309
		Turisti (Triton Mansions)	606	127
		Trunciera (Aquarium)	604	2
		Point	448	576
		Palace Hotel	0	28
161	4496	Manor Investments	3992	216

		Triq Ghawdex	499	0
		Canifore	3	3
		Costa San Antonio	1	0
		Gallina Triq il-Bahhara	1	496
2	224	Topaz Aparthotel	221	249
		Karanne	2	9
		Stanton Court	1	209
		Crown Hotel	0	1
		Topaz Aparthotel Tr. 2	0	2

### 3.3.2 Ranking with substation importance

The calculations were made factoring in the importance of the substations. Table 3-1 gives the importance value for each type of substation. Again, the ranking was done for both the primary substation feeders, as shown in Table 3-9, and for the substations in each feeder. Table 3-10 shows the results obtained. The same methodology was adopted, giving a different weighting for the NOP and the results are given in Table 3-11 and Table 3-12.

Looking at both ranking methodologies, it is evident that when the substation importance value is taken into consideration, the ranking of both the feeders and the substation change. However, the most priority feeder remained the same. All this shows that if a value is given to indicate the importance of a substation the methodology used give a better result to fulfil the DNO obligations to both the customers and to the authorities in which the DNO is operating.

Table 3-9. Feeder ranking considering substation importance – FNOP+1

Feeder No	Feeder points
6	77851
7	55369
5	41693
3	32107
1	25103
9	22549
4	3629
161	1502
2	1332

Table 3-10. Substation ranking for each feeder considering substation importance – FNOP+1

Feeder	Feeder Points	Substation	Substation Points	Customers
6	77851	San Pawl Milqi	76753	526
		Burmarrad Substation	569	36
		Price Club	526	43
		Burmarrad T/C	1	56
		Bidnija ` B ` T/C	1	12
		Bidnija ` A ` T/C	1	145
7	55369	Bugibba D.C. Local	18448	480
		Aristarku Tr. 1	18010	741
		Triq il-Pijunieri	8336	444
		St. Peter`s Court	7237	609
		Sqaq Berah	2508	590
		Sunflower Hotel	828	8
		Triq ic-Cern	2	558
		Aristarku Tr. 2	0	588
		Holiday Complex No. 2	0	2
		St. Peter`s Court Tr. 2	0	244
		Church	0	828
5	41693	Holiday Complex	34249	622
		Islet Promenade	5020	172
		Qawra Rd. (Springfield)	2049	329
		Triq it-Turisti	325	930
		New Dolmen Hotel Tr. 1	49	323
		New Dolmen Hotel Tr. 2	1	2
3	32107	Bellavista	8892	2
		Soreda	8202	14

		Santana Hotel	4398	309
		Port Ruman	4168	325
		Turisti (Triton Mansions)	2424	127
		Trunciera (Aquarium)	2416	2
		Nawciera	1381	101
		Point	225	576
		Palace Hotel	1	28
1	25103	Sewage	6875	466
		Dawret il-Gzejjer	5523	316
		Arznell	5286	1340
		Gillieru Hotel	4314	2
		San Xmun	1900	425
		San Giraldu	1204	183
		Silver Line Aparts. Tower Road	1	301
		St. Anthony	0	950
9	22549	St. Georges	4488	1093
		Drainage Pumping Station	4488	0
		Erba` Mwiezeb	3725	333
		Gov. Housing Estate (Qarbuni)	3537	188
		Emmanuel Pinto	3337	200
		Telephone Exchange	1241	262
		Near School	1136	1108
		Stella Maris	417	719
		St. Georges Wardija	180	29
		Zebbiegh Road T/C	0	38
		Villa Strickland T/C	0	52
		Hill Top Village T/C	0	29
		Villa Ivy T/C	0	7
4	3629	Frejgatina	2580	1308
		Salina Park	949	950
		Salina Wharf	87	150
		Riza Aparthotel	12	85
		Katakombi (Salina Mansions)	1	103
		Suncrest Hotel	0	2
161	1502	Manor Investments	998	216
		Triq Ghawdex	499	0
		Canifore	3	3
		Costa San Antonio	1	0

		Gallina Triq il-Bahhara	1	496
2	1332	Topaz Aparthotel	1326	249
		Karanne	4	9
		Stanton Court	2	209
		Crown Hotel	0	1
		Topaz Aparthotel Tr. 2	0	2

Table 3-11. Feeder ranking considering substation importance – FNOP+3

Feeder No	Feeder points
6	308107
7	282337
5	144581
1	40961
9	40273
3	32779
4	14213
161	4496
2	1332

Table 3-12. Substation ranking for each feeder considering substation importance – FNOP+3

Feeder	Feeder Points	Substation	Substation Points	Customers
6	308107	San Pawl Milqi	307009	526
		Burmarrad Substation	569	36
		Price Club	526	43
		Burmarrad T/C	1	56
		Bidnija ` B ` T/C	1	12
		Bidnija ` A ` T/C	1	145
7	282337	Aristarku Tr. 1	162082	741
		St. Peter`s Court	65125	609
		Triq il-Pijunieri	33344	444
		Bugibba D.C. Local	18448	480
		Sqaq Berah	2508	590
		Sunflower Hotel	828	8
		Triq ic-Cern	2	558
		Aristarku Tr. 2	0	588
		Holiday Complex No. 2	0	2
		St. Peter`s Court Tr. 2	0	244
Church	0	828		

5	144581	Holiday Complex	136993	622
		Islet Promenade	5020	172
		Qawra Rd. (Springfield)	2049	329
		Triq it-Turisti	325	930
		New Dolmen Hotel Tr. 1	193	323
		New Dolmen Hotel Tr. 2	1	2
1	40961	Arznell	21144	1340
		Sewage	6875	466
		Dawret il-Gzejjer	5523	316
		Gillieru Hotel	4314	2
		San Xmun	1900	425
		San Giraldu	1204	183
		Silver Line Aparts. Tower Road	1	301
		St. Anthony	0	950
9	40273	St. Georges	17952	1093
		Telephone Exchange	4961	262
		Drainage Pumping Station	4488	0
		Erba` Mwiezeb	3725	333
		Gov. Housing Estate (Qarbuni)	3537	188
		Emmanuel Pinto	3337	200
		Near School	1136	1108
		St. Georges	720	29
		Stella Maris	417	719
		Zebbiegh Road T/C	0	38
		Villa Strickland T/C	0	52
		Hill Top Village T/C	0	29
		Villa Ivy T/C	0	7
3	32779	Bellavista	8892	2
		Soreda	8202	14
		Santana Hotel	4398	309
		Port Ruman	4168	325
		Turisti (Triton Mansions)	2424	127
		Trunciera (Aquarium)	2416	2
		Nawciera	1381	101
		Point	897	576
		Palace Hotel	1	28
4	14213	Frejgatina	10320	1308
		Salina Park	3793	950
		Salina Wharf	87	150

		Riza Aparthotel	12	85
		Katakombi (Salina Mansions)	1	103
		Suncrest Hotel	0	2
161	4496	Manor Investments	3992	216
		Triq Ghawdex	499	0
		Canifore	3	3
		Costa San Antonio	1	0
		Gallina Triq il-Bahhara	1	496
2	1332	Topaz Aparthotel	1326	249
		Karanne	4	9
		Stanon Court	2	209
		Crown Hotel	0	1
		Topaz Aparthotel Tr. 2	0	2

### 3.4 Case Study – Restoration time for an 11kV cable fault in Bugibba

A cable fault occurred between Costa San Antonio and New Dolmen substations. The feeder from the distribution centre is towards Qawra Manor INV substation. For this analysis, the fault is assumed to have occurred after office hours.

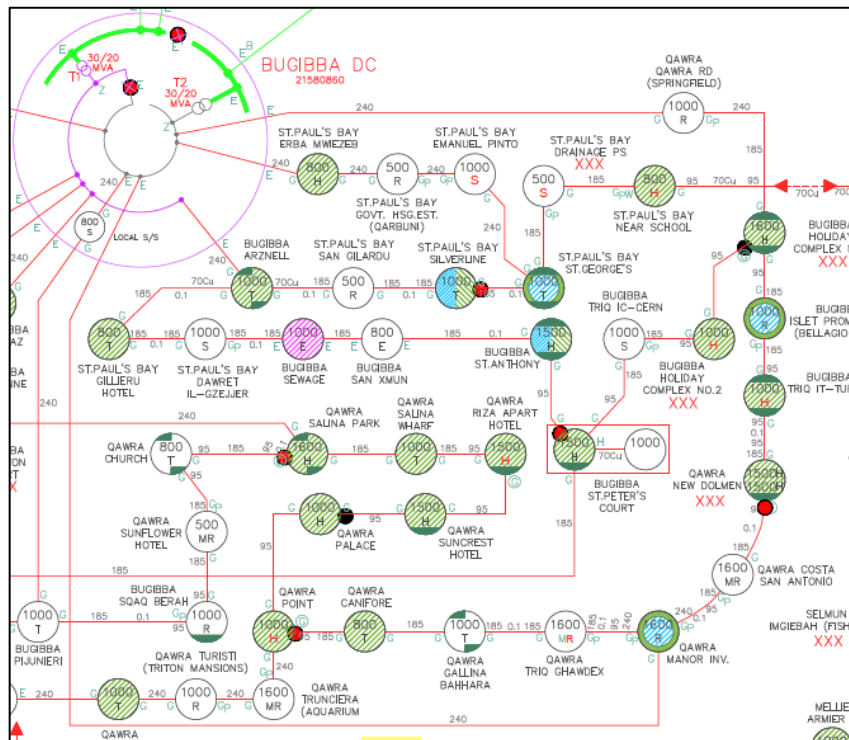

Figure 3-6. Feeder from Bugibba DC to Qawra Manor INV substation. Courtesy of Enemalta plc©

The sequence of events are the following:

1. Feeder 161, Qawra Manor Inv, trips from Bugibba Distribution Centre by earth fault protection.
2. Engineer is sent on site by the Network Control Centre (NCR)
3. Engineer checks the Earth Fault Indicator (EFI) at Qawra Manor Inv. The EFI towards Costa San Antonio was found flagged while that towards Triq Ghawdex did not flag.
4. At this point, engineer will open the switch towards Costa San Antonio substation.
5. NCR engineer will switch on the circuit breaker from Bugibba Distribution Centre.



6. Supply restored to four (4) substations, Qawra Manor Inv, Qawra Triq Ghawdex, and Qawra Canifore.
7. Engineer drives to Costa San Antonio substation and checks the EFI. This is found flagged.
8. Since EFI is upstream to the substation transformer and this transformer is protected by TLF fuses, it is decided that fault is downstream towards Qawra New Dolmen substation. Hence the switch towards Qawra New Dolmen substation is opened.
9. Engineer drives back to Qawra Manor Inv substation and switches on towards Costa San Antonio substation.
10. Last substation, Qawra Costa San Antonio is energised.
11. Engineer starts the cable fault location process on the section between Qawra Costa San Antonio and Qawra New Dolmen.

### 3.4.1 Travelling and Restoration time

Travelling time is based on Google Map directions, Figure 3-7, Figure 3-8 and Figure 3-9 show the travelling time. The travelling time given by Google corresponds to similar travelling time experienced during past faults in the same locations. The starting point of travel is the Enemalta plc Administration Building (EAB), where the Network Control Centre and engineers' offices are located. However, travelling time may differ after office hours because an engineer is called from home. Travelling time could be depending on where he lives and where the fault is located. Referring to the Google time for faults that may occur during office hours is a good assumption to estimate the duration of the restoration time.



Figure 3-7. EAB to Qawra Manor Inv substation

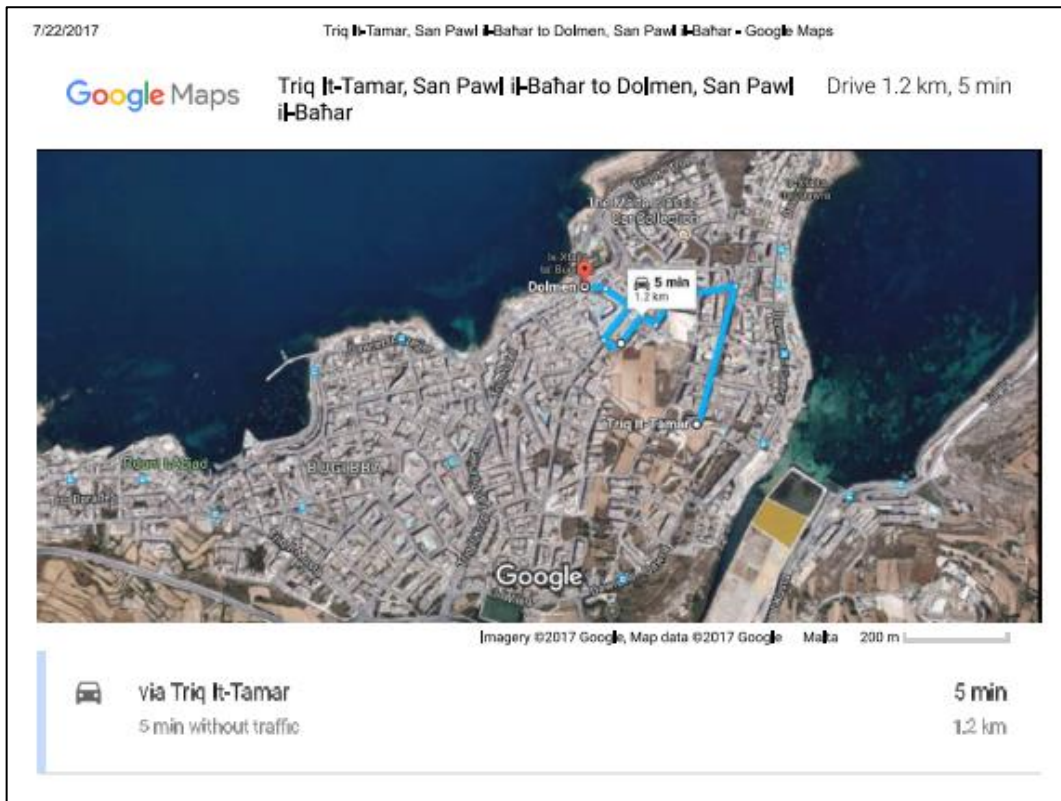

Figure 3-8. Qawra Manor Inv substation to Qawra Costa San Antonio substation



Figure 3-9. EAB to Qawra Costa San Antonio substation

### 3.4.2 Sequence of events considering substations without automation

1. Bugibba Distribution Centre CB trip received at NCR via SCADA
2. EAB to Qawra Manor Inv substation – 26 minutes
3. Qawra Manor Substation inspection and call NCR – 5 minutes
4. NCR switch on CB at Bugibba Distribution Centre – 1 minute
5. Four substations are energised after **32 minutes**.
6. Qawra Manor Inv to Qawra San Antonio – 5 minutes
7. Engineer inspects, calls NCR and switches off switch towards Qawra New Dolmen – 3 minutes
8. Qawra San Antonio to Qawra Manor – 5 minutes
9. Qawra Manor Inv substation, engineer switches on towards Qawra Costa San Antonio – 3 minutes.
10. Last substation is energised 16 minutes after the others hence after **48 minutes**.

Total time is  $32 + 16 = 48$  minutes from trip

This is shown graphically in Figure 3-10.

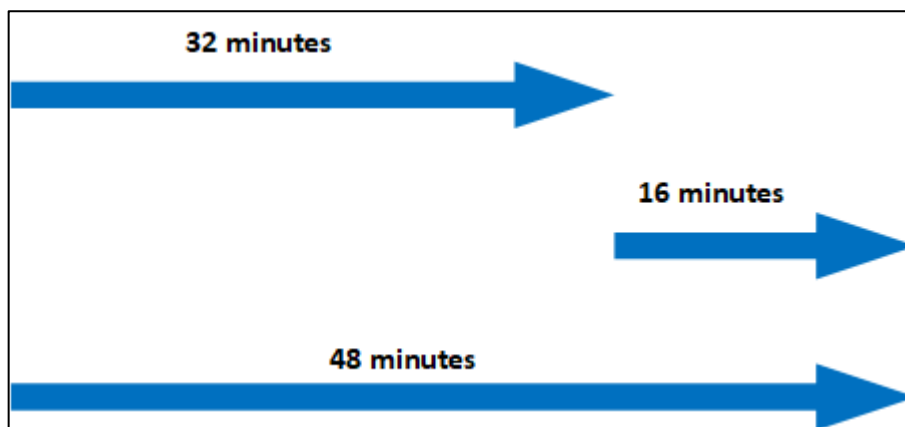

Figure 3-10. Timeline without automation

### 3.4.3 Sequence of events considering a substation with automation (Qawra Manor)

1. Bugibba Distribution Centre CB trip received at NCR from SCADA
2. Qawra Manor Inv EFI active received by SCADA at NCR
3. From the above information, NCR opens switch at Qawra Manor towards Qawra San Antonio and switches on the CB at Bugibba Distribution Centre.
4. Four substations are energised after **5 minutes**.
5. EAB to Qawra Costa San Antonio substation – 31 minutes
6. Engineer inspects, calls NCR and switches off switch towards Qawra New Dolmen – 3 minutes
7. NCR closes the switch at Qawra Manor towards Qawra Costa San Antonio – 3 minutes
8. Last substation is energised after **37 minutes**.

Total time is  $0 + 37 = 37$  minutes from trip

This is shown graphically in Figure 3-11.

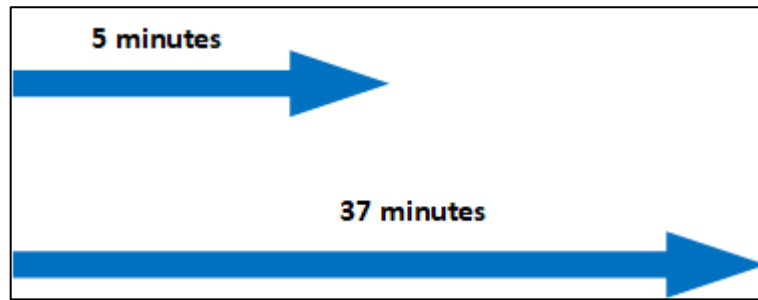

Figure 3-11. Timeline with automation

### 3.4.4 Lost Revenue for the Distribution System Operator

From the above-mentioned case study, it emanates that there will be a foregone revenue for Enemalta plc covering the time of interruption until the supply was restored back to all substations. The energy not supplied by Enemalta plc to customers represents the revenue lost during the duration of the interruption.

The Customer Average Interruption Duration Index (CAIDI) is used to calculate the average interruption a customer will experience.

CAIDI is given by:

$$CAIDI = \frac{\sum \text{Customers Minutes of Interruption}}{\text{Total Number of Customers Interrupted}} = \frac{CMI}{CI} = \frac{\sum r_i N_i}{\sum N_i} = \frac{SAIDI}{SAIFI} \quad (5)$$

The lost revenue for each interruption, with automation or without, is given by the equation

$$\text{Total Cost per kWh} = \text{Cost/kWh} \times \text{No of Meters} \times \frac{\text{kWh}}{\text{h.M}} \times \frac{\text{restoration time(min)}}{60} \quad (6)$$

The Reduction in Lost Revenue, RLR, is given by

$$RLR = \frac{\text{Total Cost/kWh without automation} - \text{Total Cost/kWh with automation}}{\text{Total Cost/kWh without automation}} \times 100\% \quad (7)$$

CAIDI results are as follows:

CAIDI without automation

$$CAIDI = \frac{(216 \times 32) + (1 \times 32) + (496 \times 32) + (3 \times 32) + (1 \times 48)}{717} = \frac{22960}{717} = 32.02 \text{ min}$$

CAIDI with automation

$$CAIDI = \frac{(216 \times 5) + (1 \times 5) + (496 \times 5) + (3 \times 5) + (1 \times 37)}{717} = \frac{3617}{717} = 5.05 \text{ min}$$

Table 3-13. Lost revenue assuming consumption of one kWh per meter

Substation	Restoration time minutes		No of Meters	Energy per hour per meter kWh/h/M	Remarks	Cost per kWh Euro	Total Cost Euro	
	No	Yes					No	Yes
	Automation						Automation	
	No	Yes					No	Yes
Qawra Manor Inv	32	5	216	1		0.1047	12.06	1.88
Qawra Triq Ghawdex	32	5	1	1	Hotel	0.1215	0.06	0.01
Qawra Gallina Bahhara	32	5	496	1		0.1047	27.69	4.32
Qawra Canifore	32	5	3	1	Hotel included	0.1215	0.19	0.03
Qawra Costa San Antonio	48	37	1	1	Hotel	0.1215	0.09	0.07
All	48	37	<b>717</b>		Total		40.09	6.31
						RLR	6	times
							84.2%	



Table 3-14. Lost revenue considering actual consumption

Substation	Restoration time minutes		No of Meters	Energy per hour per meter kWh/h/M	Remarks	Cost per kWh Euro	Total Cost Euro	
	No	Yes					No	Yes
	Automation					Automation		
	No	Yes				No	Yes	
Qawra Manor Inv	32	5	216	1		0.1047	12.06	1.88
Qawra Triq Ghawdex	32	5	1	50	Hotel	0.1215	3.24	0.50
Qawra Gallina Bahhara	32	5	496	1		0.1047	27.69	4.32
Qawra Canifore	32	5	3	50	Hotel included	0.1215	9.72	1.52
Qawra Costa San Antonio	48	37	1	50	Hotel	0.1215	4.86	3.74
All	48	37	<b>717</b>		Total		57.57	11.96
						RLR	5	times
							79.2%	

It is noted that if one substation is equipped with automation equipment, as in this case study, Qawra Manor Inv is automated, the restoration time is reduced drastically, by 27 minutes, for the first four substations. The last substation restoration time was also reduced, but only by 6 minutes in view that this substation is operated manually.

In Table 3-13, it is assumed that each customer consumes one unit per hour. So, the revenue lost for the duration of the outage is calculated. However, one can apply the actual units consumed in one hour per substation and then one needs to average this on the number of meters connected to the substation to obtain a more realistic result. Such data can be obtained from the substation master meter. Table 3-14 workings are based on the actual consumptions. The actual consumption is obtained from the master energy meter installed in the substation.

As can be seen, the revenue lost without automation is €40.09 while with automation it is €6.31.

So, reduction in revenue lost by not having automation is  $40.09/6.31 = 6.35$ , therefore, it is 6 times as much.

Calculating this as a percentage:

$$\text{Reduction in Lost Revenue (RLR)} = \frac{40.09 - 6.31}{40.09} \times 100 = 84.2\%$$

If it is assumed that the hotels consume **50 units per hour**, then the revenue lost by Enemalta plc without automation is €57.57 while with automation goes down significantly to €11.96, as shown in Table 3-14.

So, reduction in revenue lost by not having automation is approximately  $57.57/11.96 = 4.81$ , therefore, it is 5 times as much.

Calculating this as a percentage:

$$\text{Reduction in Lost Revenue (RLR)} = \frac{57.57 - 11.96}{57.57} \times 100 = 79.2\%$$

These results show that consumers, who have high demand per hour, must have their supply restored in the shortest time possible to reduce the amount of lost revenue. This means that the necessary weighting is to be given for high demand customers when decisions are taken to identify the best substations to automate or to be given priority.

### 3.5 Summary

Most of the papers mentioned in the literature review, analyse a network from the system perspective and they use the system indices SAIFI or SAIDI. Other papers consider the cost of implementation and cost of interruption. This research, although acknowledges that SAIFI and SAIDI are used by utilities to benchmark their networks with others, will consider the CAIDI indices, which directly reflects the connected customer satisfaction. Hence if CAIDI is improved, customer satisfaction increases, and this will be an achievement for a distribution system operator. CAIDI will vary from one area to another, and this is related to the network topology, network capacity and reachability together with type of customers located in that area. The research investigated a typical network, obtained the best location for automation devices to be installed and compared this with actual restoration of faults in the same area.

A case study was carried out in the Bugibba area looking at an actual fault and the time taken to restore the supply. Using the mathematical equations developed to rank the best substation where automation can be installed, the same fault was again analysed, and restoration time was calculated. It is shown that there was a significant improvement in the CAIDI analysis, by 27 minutes. This improvement may have not been so high if one looks at SAIFI and SAIDI given that the number of substations interrupted is small when compared to the full 11kV network system. The number of substations interrupted are about 1% of the total connected substations but have a direct impact of about 100% on the customers in the area.

The case study also looked at lost revenue that will result from such power interruptions. First analysis assumed that each connected customer consumes 1kWh per hour irrespective if this was residential, commercial, or industrial. This gave a result of 84% reduction for the lost revenue. The second analysis considered more realistic values of consumptions.

Commercial customers, normally, do have a higher consumption than a residential customer. This gave different results, that of 79% reduction in lost revenue, and indicated that customers with higher consumption may rank on a higher priority when supply is being restored. Commercial customers, such as hotels and restaurants, most of the time do have a backup generator. Such generators will give the basic needs for such establishments to ensure business continuity. However, the full power capacity from a DSO network is always required. The cost of running backup generators is much higher than the cost of consumption billed by a DSO.

The method presented in this chapter used a spreadsheet to do the required calculations, given that only part of a network was analysed. However, if a larger network is to be analysed it is necessary that the equations developed are included in an iterative algorithm combining all requirements to select the most efficient location. This can be achieved by developing a Matlab model for the same network. Switching location optimisation will considering CAIDI instead of SAIDI and SAIFI.

The ranking system method concept achieved from this chapter lead to a deeper analysis using optimisation algorithm to improve the selection of substations.

## Chapter 4 - Optimum locations considering restoration time

Chapter 3 introduced concepts how to rank substations based on the number of customers connected to a substation, the switching time duration arising from various restrictions and the type of customers connected to a substation. Each substation was given a ranking value based on its importance. The value was attributed either to the type of load being fed from the substation or else to the constraints that the substation location offers. However the importance rank value was based on experience obtained from the DSO engineers.

This chapter identifies different operational times that together will define the duration required to restore supply following a fault. Each operational time is measurable and can be quantified. Each substation can have different constraints and hence different operational time. This could arise from the location, if it is in a rural area or within a city, the type of switchgear and the access to the substation. New substations will not have switchgear restrictions but may have access or site location restrictions. Existing substations need to be assessed and the different type of restrictions identified, if any. The optimisation method is applied to a network that is already operational and a one that has expanded during the years. Therefore, substations are equipped with different type of switchgear and may had their surrounding environment changed from the time they were built. The optimal selection of substations, which will have their switchgear retrofitted with automation, is achieved using the optimisation algorithm.

### 4.1 Methodology

The analysis in this chapter is as follows:

1. Break up the restoration time in various operational and restrictions time
2. Identify typical scenarios encountered in real situations
3. Solution formulations for Customer Minutes Lost
4. Obtain data from a typical real Medium Voltage network
5. Analyse networks with more than one feeder

6. Suggest the optimum substations to be automated based on the budget available and the actual RTU cost for the selected substations

Matlab was used to analyse the various networks. Code was created to define the solutions formulations which were then applied to networks using the substation data obtained from real networks.

#### 4.1.1 Genetic Algorithm (GA) optimisation function

The Genetic Algorithm optimisation function referred to in Appendix A was used to determine which substations are to be automated. The function randomly suggests which substations are to be automated, then these are used in the solution formulations and the result obtained is passed back to the GA function. The GA will then determine another set of substations that can be automated and again a result is obtained from the solution formulation. The minimum result value that can be obtained by considering different substations locations and the restrictions that they offer will be the optimum value. Once the optimum value is produced by the GA function, the GA will suggest the optimum substations to be automated.

#### 4.1.2 Distribution System Operator financial budget

New MV networks may be fully automated, but this requires substantial investment. Hence, it is critical to identify the best substation location where remote operating devices may be installed.

Each substation is equipped with existing MV switchgear that was provided by different suppliers; hence each supplier has its own automation equipment that can retrofit in the supplier equipment. The solutions formulations consider the budget availability and the actual cost of the automation equipment required for each type of switchgear. Doing so, the optimum selection of substations that are to be automated are based on the optimum number of substations that can be automated with the available budget.

The actual RTU cost depends on the type of switchgear installed in each substation. Best practice is to install an RTU provided from the same switchgear manufacturer. This will ensure that the integration between the RTU and the switchgear mechanism is much easier. Therefore, the RTU cost varies between manufacturers. When the cost of RTU is not known, as a rule of thumb, the automation cost per substation is estimated at €10,000. Ideally, the budget available should cover the cost to automate all substations in a network and this will be taken into consideration as the final indicator in this research. Given that the estimated cost per substation is €10,000, the analysis will take this value as a step increment in the budget until the maximum budget available is reached. This will ensure that the method is able to identify the optimum locations with each incremental budget. The method will also allow the maximum budget to be modified according to the funds available by the DSO.

For a network with 20 substations, the maximum budget required will be €200,000.

Typical costs for different RTU types are given in Table 4-1. The costs given were used to obtain the optimum number of substations based on the switchgear type. The costs for the mentioned RTUs will vary between countries and between DSO in the same country, so each DSO must evaluate the RTU type cost based on its expenditure.

The budget and actual cost given in tables and graphs are in Euro.

*Table 4-1. RTU Type typical costs*

RTU Code	RTU Type	Cost €
0	Not known	10,000
1	Lucy Gemini	3,000
2	Schneider T200	5,000
3	Schneider T300	7,000
4	Siemens CMIC	4,000
5	Allen Bradley	3,500

## 4.2 Restoration of supply

The restoration of supply duration is the time taken from when the electricity supply is interrupted until the supply is restored back to each load connected to the LV networks supplied from one or more substations.

The duration depends on a number of factors that are related directly to the MV network components and the response by the DSO to restore the supply. Restrictions exist and these will contribute to the delay in restoring the supply to a customer.

The following operating times are considered.

- Normal operating time
- Site access time
- Operational restriction time
- Substation location time

### 4.2.1 Normal Operating Time (NOT)

The normal operating time is the outage time until the supply is restored to a substation. It is a function of operations done to switch on or off the switchgear in substations. The switching operations can either be done locally, MLO, or else remotely, MRO, from a network control centre. It is to be noted that both methods are not done through an automated process.

#### 4.2.1.1 Manual Local Operation (MLO)

MLO requires that an engineer attends on site, in a substation, and follow the standard procedures to operate the MV switchgear by using operating handles. This includes the



travelling time to arrive at the substation. MLO does not include any other restrictions that may increase the switching operating time.

#### 4.2.1.2 Manual Remote Operation (MRO)

MRO requires that the control centre engineer to be present in the network control room and follow the standard procedures to operate the MV switchgear through a SCADA system. This does not include travelling time and hence the duration is much less.

#### 4.2.2 Additional restrictions time

Other restrictions may be present when attending a substation to perform a switching operation and restore the supply following a fault.

This additional restriction time is related to the substation site access, switchgear operational restrictions and the substation location. These restrictions are most of the time encountered in real-world MV networks during the supply restoration process.

##### 4.2.2.1 Site Access Time (SAT)

Substations are built at street level, below or above street level. Most of the substations are either at street level or else below and very few may be above street level. So, access to a substation will require additional time. There are several factors that will delay the access to a substation. A substation can be in a private building, within the perimeter of factories, hotels, water or sewage treatment plants etc. Some may have different access duration since an engineer might require access through a security system, wait for someone to open the premises or if located at basement level, there is additional time to reach the substation from street level.

Each substation may have different access time, but an average time was taken and applied for all substations. The average time was based on practical experience gained through many years. However, one can quantify each delay entry and add this to that specific substation. Doing so the database is updated and improved. To achieve this the DSO must wait for a fault to happen, visit the site or else discuss the matter with engineers who had attended the substation on previous occasions. As mentioned, there is always the possibility that delay time can vary each time there is a visit to the substation, so an average time is a good guess that can be assumed.

#### 4.2.2.2 Operational Restriction Time (ORT)

Substations are equipped with different types of switchgears. There are types of switchgears, particularly oil type, which have been issued with operational restrictions, known as 'Suspension of Operational Practice,' SOP, either by the DSO, the manufacturer or else by national authorities. Some switchgear types may have an SOP applied that required dead operations, i.e., switchgear can only be operated when de-energised. Other may recommend using a Remote Operating Device (ROD) kit to reduce the risk of injuries associated with switching operations. The ROD kit can be either by fitting a motorised actuator and operate it remotely or else by using a lanyard pulley system. ROD kits are designed to be used to operate switchgear remotely from a certain safe distance of about 5m. The intention is to isolate the engineer, normally operating the switch from a close distance of about 1m, from the switchgear thus reducing the likelihood of injury if the switch fails catastrophically during the operation procedure. Whatever the type of ROD kit device is used, time is required to attach the device to the switchgear and perform the required operation. Different ROD devices methods require different times, but a DSO can take an average time for the different remote operating devices methods.

Other operational restrictions apply for any type of switchgear, but which is installed say in a container. Such containers are used to house switchgear and transformers to supply PV farms in rural areas where building permissions for rooms having the right dimension of a substation or even larger is not permitted.

#### 4.2.2.3 Substation Location Time (SLT)

Substation location within a distribution network can be in rural areas, villages, towns, and cities. Driving from the control centre to any of these locations require additional time.

Travelling time to substations in cities where traffic could be a hindrance, may be longer than that for reaching a substation located in a village.

Concluding for SAT, ORT and SLT, these are time durations that are not included in the normal operation time and hence must be added to the normal operating time.

### 4.3 Operational time duration

During this research, the time required to perform local or remote operation together with operational restrictions time used, are given in Table 4-2. The duration being considered is an average time that is required for each operation based on the practical experience of the researcher and discussions with engineers. A DSO can discuss and modify the duration being presented in view that in practice not all the substations have the same pattern of restrictions. However, some degree of tolerance should be allowed. Operational time can be assigned to each substation, which will be more accurate, but even for the same substation the operation time can vary because the operation is done by different persons. Human beings' experience and efficiency vary and this will reflect in the required operational time. Therefore taking an average time should serve well for the analysis being presented.

Table 4-2. Operational Time Code and expected restoration time

<b>Operational Time Code</b>	<b>Minutes</b>	<b>Description</b>
MLO	60	Manual Local Operation
MRO	15	Manual Remote Operation
SAT	15	Site Access Time
ORT	10	Operational Restriction Time
SLT	20	Substation Location Time

MLO is achieved by considering the time taken for an engineer to travel from the company's premises to the substation and add the time required to perform a manual operation.

Google maps can be used to estimate the time required from one location to another. Figure 4-1 shows the driving time from a central office to a substation. Different routes are given so an approximation is necessary. Additional time is required to be included, the time from when the fault notification was communicated to the engineer, preparing the required tools, driving to the location, access the substations, do the necessary switchgear checks, and then operate the switchgear. For this study, MLO is set at 60 minutes.

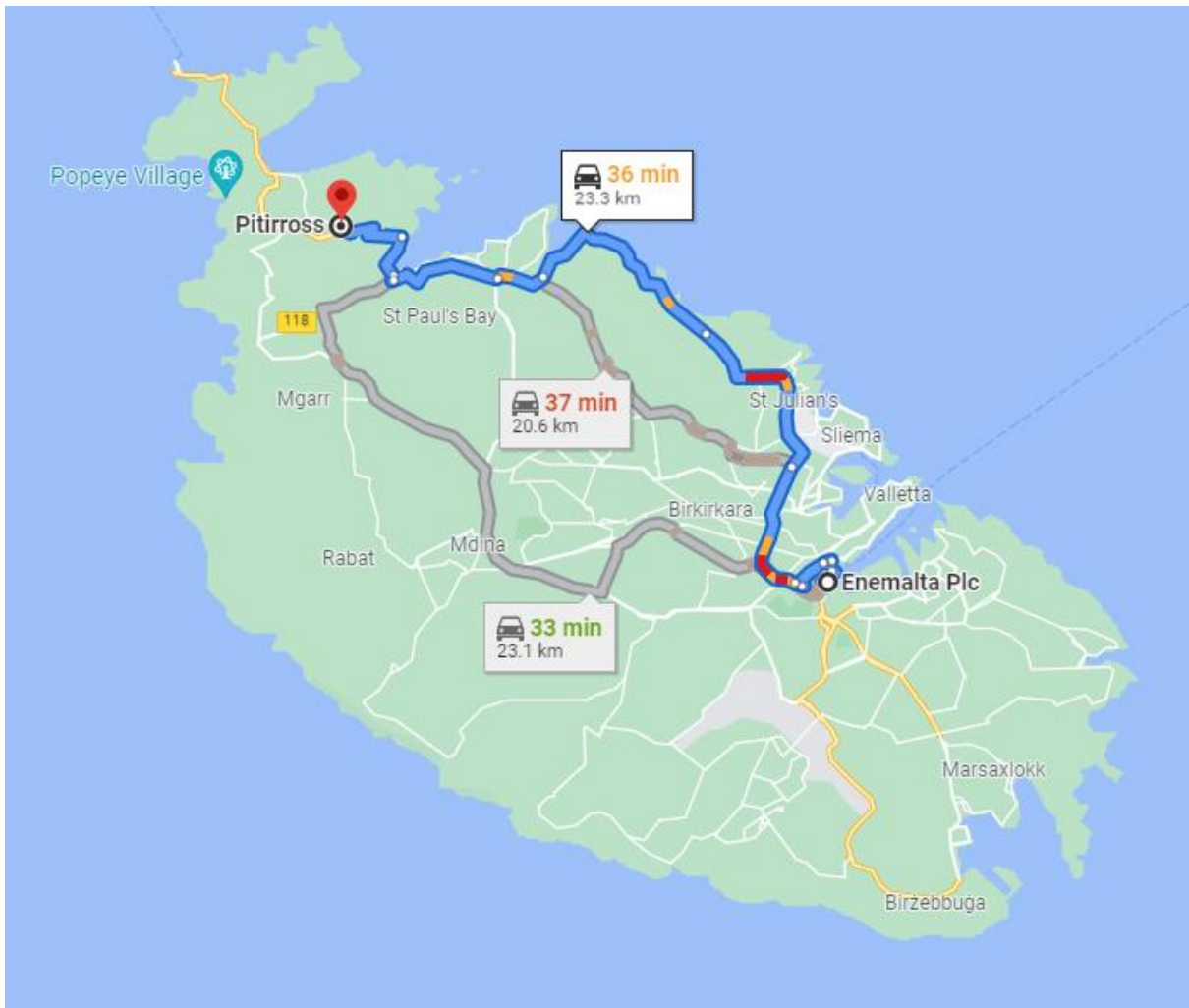

Figure 4-1. Google Map driving time. Engineers' office to substation.

MRO is set at 15 minutes, and this is the time required for a control room engineer, from when the alarm was raised on the SCADA system, evaluate the alarm, consider what actions need to be taken and then execute the switching operation through the SCADA system.

SAT is the additional time required once an engineer reaches the location of the substation. This is the time taken due to some access restrictions, saying going in through a security system, ask residents to access the substation, etc. This is set at 15 minutes.

ORT is the additional time required to perform a safe operation on a switchgear which has some operational restriction. ORT is set at 10 minutes, and this is the approximate time to assemble a remote operation device.

SLT is the time required to arrive at the location of the substation where driving time is increased due to location driving restrictions. This is set at 20 minutes.

#### 4.4 Network automated methods

Three arrangement methods will be considered, where:

1. No substations are automated, hence only manual local operation is possible
2. Normally Open Points substations are equipped with remote operated switches.
3. Optimum selection of substations to be equipped with remote operated switches.

The first method is from where each DSO departs with the operation of the MV network. MV networks existed for many years and continued to expand over the years. Remote operation was not a necessity and very few substations had this capability, those equipped with circuit breakers. This meant all required operations were performed manually on site.

The second method will consider the Normally Open Points already equipped with remote operating devices. In addition, there may be other substations that have already been equipped with such devices but this was not necessarily done through an optimisation method.

The third method will continue on the second state and will identify those substations that if automated the best optimum minimum value being calculated is achieved. This is achieved by incrementing the allocation of funds available until the total budget is reached. The increment value is based on the estimated cost required to automate one substation.

The three arrangement methods are applied to a network where all substations do not have any type of operational restriction and then the same scenarios are applied to the same network having some substations with some type of restriction.

## 4.5 Customer Minutes Lost (CML)

The duration time that a customer experience without electricity supply is defined as the customer minutes lost. CML identifies the duration without supply that a customer experience for an MV branch fault. The time duration is calculated from when the customer experienced the loss of supply until it was restored back permanently.

The objective function for customer minutes lost is given by:

$$\min f = \sum CML_{bf} \quad (8)$$

The selected parameters for the GA are shown in Table 4-3. The population size and the number of variables depend on the size of the network being analysed.

Table 4-3. GA Parameters

Parameter	Value
Number of Variables	Candidate substations for automation
Population Size	Substation nodes
Maximum Generations	100
Maximum Stall Generations	20
Number of Runs	5

The objection function terms to calculate the time required to restore customers are given below. These are based on normal manual operation time, remote operation time and other constraints that arise from substation access, location and switchgear restrictions.

Following a branch fault, some substations may have their supply restored back before the faulty branch is isolated. This could be done if one or more substations have an RTU

installed. The customer minutes lost for the restorable busbars,  $CML_{rb}$ , are obtained by using the following equation

$$CML_{rb} = \sum N_j \times T_{MRj} \quad (9)$$

For the faulted busbars, the customer minutes lost are obtained using the following equations.

The CML for the substations upstream to the faulty branch,  $CML_{up}$  is calculated using

$$CML_{up} = \sum_{i=1}^n N_{up} (T_{MLj} + T_{SAj} + T_{ORj} + T_{SLj}) \quad (10)$$

For the substations downstream to the faulty branch, CML is calculated using equation (11)

$$CML_{dw} = \sum_{i=1}^n N_{dw} (T_{MLj} + T_{SAj} + T_{ORj} + T_{SLj}) \quad (11)$$

Therefore, the customer minutes lost for the faulted buses is

$$CML_{fb} = CML_{up} + CML_{dw} \quad (12)$$



The customer minutes lost for the branch fault is the sum of both the restorable and faulted busbars, hence:

$$CML_{bf} = CML_{fb} + CML_{rb} \quad (13)$$

Calculations are done for each branch fault considering the proposed substations to be automated. The results for each branch fault are then summed up and the value is given to the optimisation function. The process is shown in Appendix A. This process is repeated until the optimisation function obtains the most optimum value. Once the optimum value is obtained the optimisation function will provide the substations to be automated.

*Figure 4-2. Optimisation Flow Chart*

Figure 4-2 shows the process flow for the optimisation process.

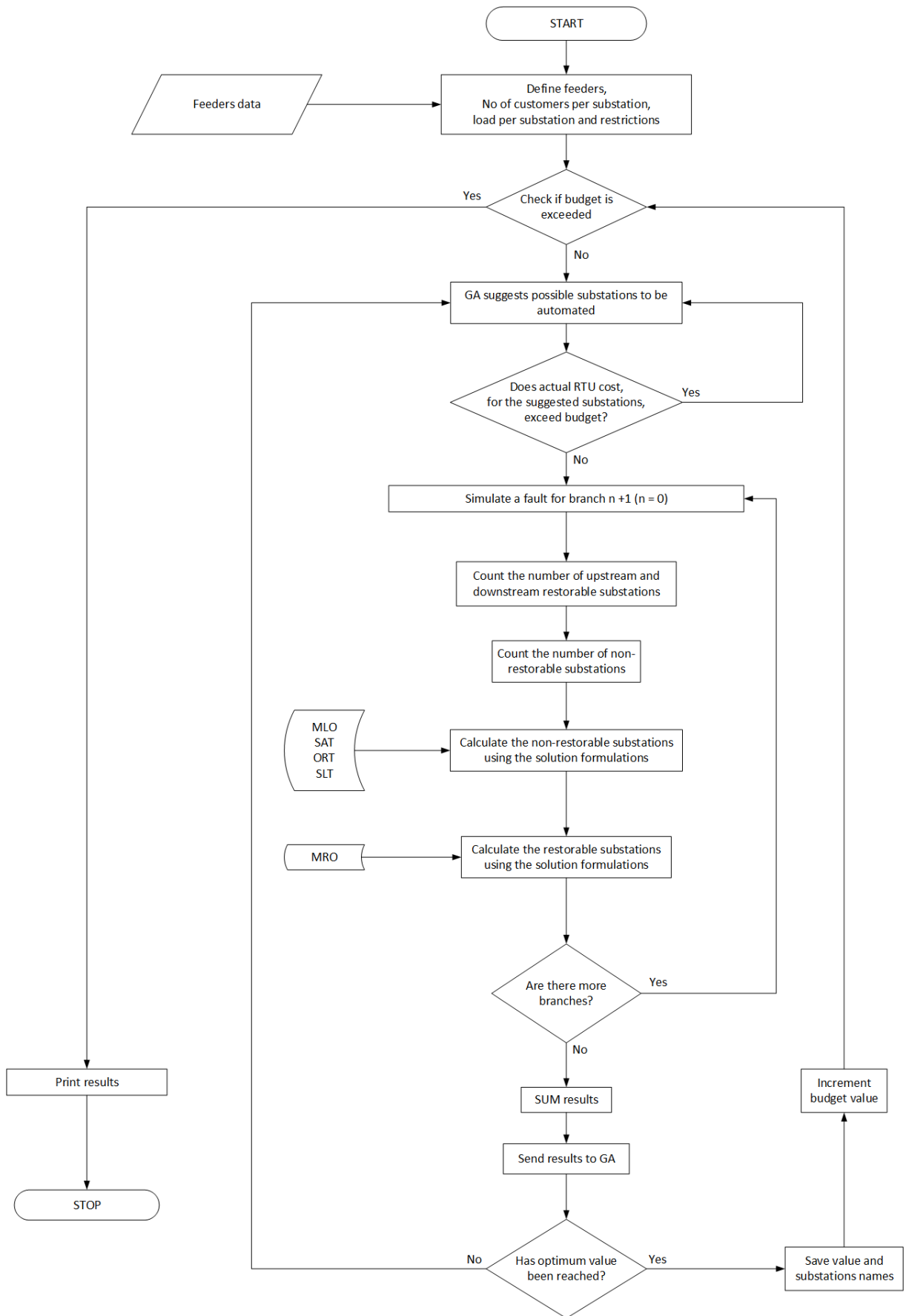

Figure 4-2. Optimisation Flow Chart

## 4.6 Substation data

Substation data is required because it will give several information that will be used in the methodology used in this research. All the analysis and the results obtained will be based on the asset data and the number and type of customers connected to the same substation.

The data available for a substation, that can be used for the required analysis, is as follows:

- Node number
- Substation ID
- Feeder ID
- Locality
- Substation name
- Count of meters, number of meters connected to the substation. A meter is considered as one customer.
- Transformer rating
- On/Off, transformer is energised
- SSI, substation importance value
- Substation restrictions, SAT, ORT and SLT. These are set at '0' or '1'. The actual time is defined in the algorithm
- RTU type

Remote Terminal Units, RTU, installed in substations are from different manufacturers and usually the choice depends on the type of MV equipment installed in the substation. Preferably, an RTU must match with the motorised actuators installed on switchgear such as RMUs, this for faster integration. As such, whenever there is a reference to an RTU, it also refers also to the motorised actuators required to control the switchgear operation. Typical RTUs are given in Table 4-4. Based on the type of RTU, the actual cost for each substation is determined and used to optimise the budget available by the DSO. Costs of RTUs are given in Table 4-1.

Table 4-4. Type of RTUs

Code	RTU type based on switchgear type
0	Not known
1	Lucy Gemini
2	Schneider T200
3	Schneider T300
4	Siemens CMIC A8000
5	Allen Bradley

#### 4.7 Two-feeder network with 11 substations

A two-feeder network was created having one source bus and ten secondary substations. The data used for each substation is based on typical data that can be obtained from DSO networks.

The single line diagram for the two-feeder network is shown in Figure 4-3.

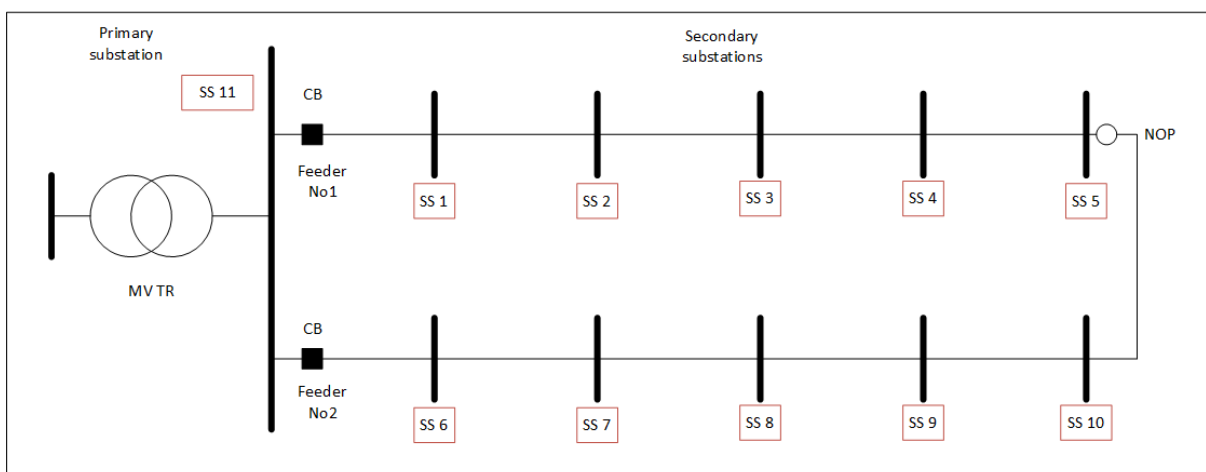

Figure 4-3. Two-feeder network single line diagram

For this analysis, it is assumed that there is a budget to cover the average substation cost of €10,000 each. So, the maximum budget is set at €200,000. The algorithm considers the type of RTU and its cost based on the switchgear type in each substation. For example, Lucy, Schneider and Siemens. The RTU cost depends on the manufacturer and can be different from the assumed cost per substation. This means that with the same budget, more substations may be automated for the allocated budget.

The network data is given in Table 4-5.

*Table 4-5. Data for a two-feeder network*

<b>Information</b>	<b>Data</b>
Budget available	€200,000
Estimated Cost per substation	€10,000
No of substations	10
No of Source Buses	1
No of Feeders	2
No of Automated substations	0
No of Automated Normally Open Points	1

#### 4.7.1 Substations without any restrictions

For each substation the substation name, transformer rating and number of energy meters connected are given in Table 4-6. The substation importance is set to be the same for all substations. The table also shows the type of RTU required.

Table 4-6. Data for two-feeder networks without any restrictions

NODE No	Substation name	Connected Meters Qty	Transformer Rating kVA	Substation Importance SSI	Site Access SAT	Operational Restrictions ORT	Site Location SLT	RTU Type
1	SS 1	221	500	1	0	0	0	0
2	SS 2	201	500	1	0	0	0	1
3	SS 3	220	500	1	0	0	0	2
4	SS 4	1	1000	1	0	0	0	3
5	SS 5	1	500	1	0	0	0	2
6	SS 6	374	500	1	0	0	0	2
7	SS 7	1	500	1	0	0	0	2
8	SS 8	686	500	1	0	0	0	1
9	SS 9	10	250	1	0	0	0	1
10	SS 10	722	1000	1	0	0	0	4

The results for the two-feeder network are given in Table 4-7. The more substations are automated, the Customer Minutes Lost will be reduced, as expected. This is shown in Table 4-7. Without any automation, the Customer Minutes Lost value is calculated at 731100 minutes. When the NOP are automated, CML reduces to 730875 minutes. Subsequently, for the first budget, three substations were selected for automation by the optimisation process. This resulted in a CML of 284025 minutes. The CML value saturates from the 5<sup>th</sup> budget increment onwards. This shows that investing in more automated substations beyond this point does not justify the marginal improvement achieved. Therefore, a decision can be taken not to automate additional substations beyond the 5<sup>th</sup> budget increment.

Table 4-7. CML Results for a network with two feeders and without restrictions

Automated substations	Budget Increment (Euro)	Customer Minutes Lost (min)	Actual Cost (Euro)	Substations to automate (Node Number)										
No substations automated	0	731,100	0	Nil										
Already automated substations	0	731,100	0	Nil										
Normally Open Points to automate	0	730,875	5,000	5										
1	10,000	284,025	10,000	2	8	10								
2	20,000	203,745	20,000	2	3	6	8	10						
3	30,000	183,855	30,000	1	2	3	6	8	10					
4	40,000	182,865	40,000	1	2	3	4	6	8	9	10			
5	50,000	182,775	45,000	1	2	3	4	6	7	8	9	10		
6	60,000	182,775	45,000	1	2	3	4	6	7	8	9	10		
7	70,000	182,775	45,000	1	2	3	4	6	7	8	9	10		
8	80,000	182,775	45,000	1	2	3	4	6	7	8	9	10		

Figure 4-4 shows graphically the Customer Minutes Lost and the Actual RTU Cost against the incremental budget. This includes those substations that are already automated, such as the normally open points.

Figure 4-5 shows graphically the same results but this time the previous automated substations are removed so that they do not affect the comparisons between the budget available against the actual RTU cost and optimised customer minutes lost.

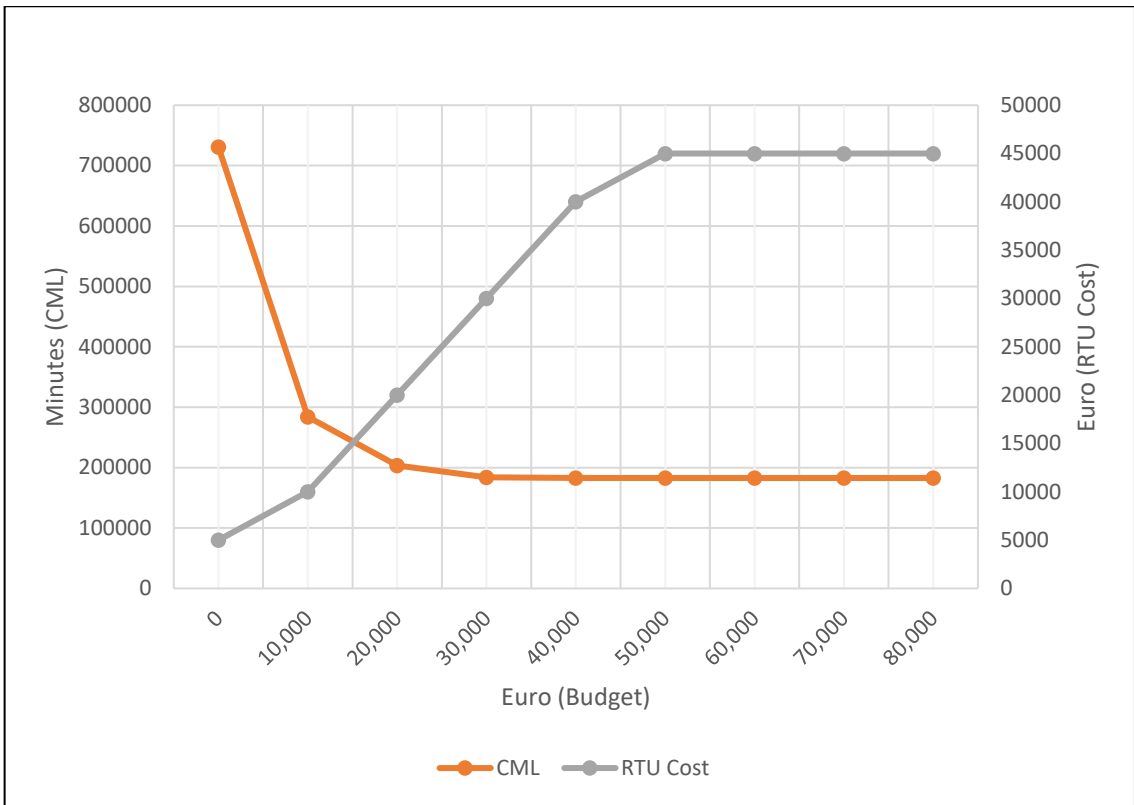

Figure 4-4. Two-feeders - CML vs RTU Cost for all automated substations

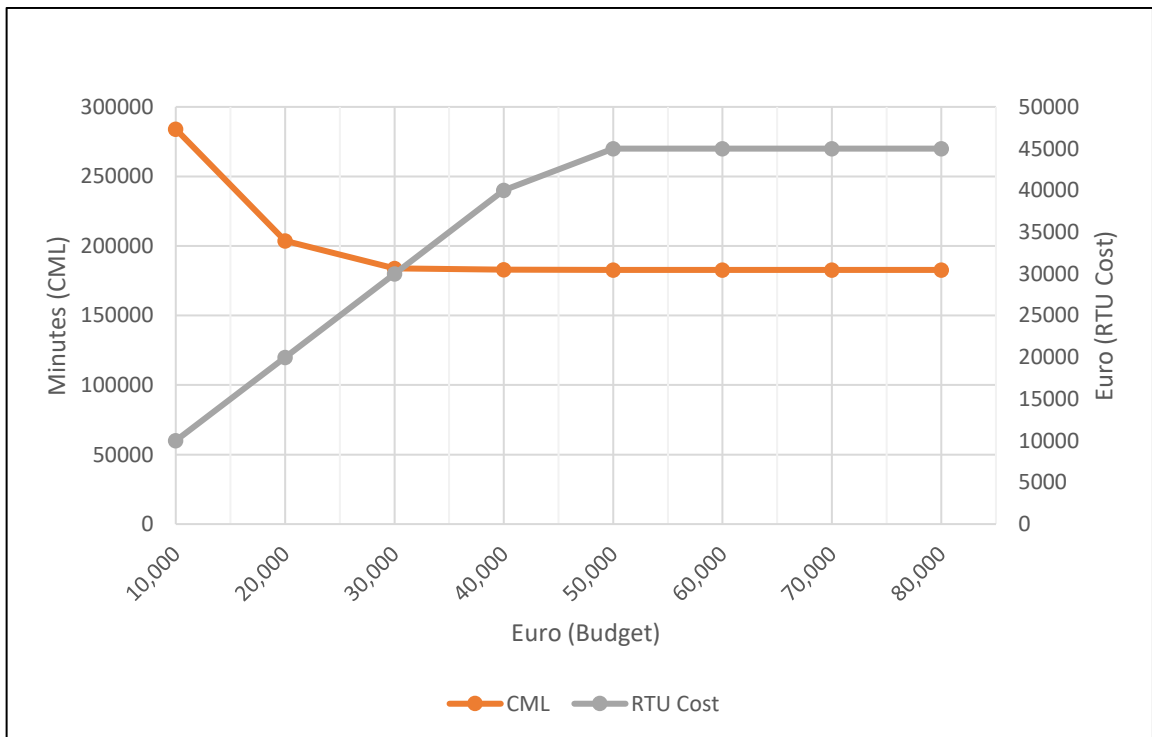

Figure 4-5. Two-feeders - CML vs RTU Cost considering budget only, excluding already automated substations



#### 4.7.2 Substations with restrictions

For the same two-feeder, network restrictions, for each substation, is applied. Site access SAT, switchgear operational ORT and site location SLT restrictions were assumed for each substation. SAT, ORT and SLT are set at '0' or '1' as shown in Table 4-8. Those set at '1' are included in the normal operation time before the customer minutes lost are calculated.

Table 4-8. Data for two-feeder networks with restrictions

NODE No	Substation name	Connected Meters Qty	Transformer Rating kVA	Substation Importance SSI	Site Access SAT	Operational Restrictions ORT	Site Location SLT	RTU Type
1	SS 1	221	500	1	0	1	0	0
2	SS 2	201	500	1	0	0	1	1
3	SS 3	220	500	1	0	0	0	2
4	SS 4	1	1000	1	1	1	1	3
5	SS 5	1	500	1	1	0	1	2
6	SS 6	374	500	1	0	0	1	2
7	SS 7	1	500	1	0	1	0	2
8	SS 8	686	500	1	0	1	0	1
9	SS 9	10	250	1	0	0	0	1
10	SS 10	722	1000	1	0	1	0	4

The results for the two-feeder network are given in Table 4-9. Again, Table 4-9 shows that the overall Customer Minutes Lost is reducing the more substations area automated. The reduction of CML will saturate at some point, meaning that investing in more automated substations does not justify the marginal improvement achieved.

Table 4-9. Results for two-feeder networks with restrictions

Automated substations	Budget Increment (Euro)	Customer Minutes Lost (min)	Actual Cost (Euro)	Substations to automate (Node Number)									
No substations automated	0	1,133,500	0	Nil									
Already automated substations	0	1,133,500	0	Nil									
Normally Open Points to automate	0	1,133,045	5,000	5									
1	10,000	357,215	10,000	2	8	10							
2	20,000	209,555	20,000	2	3	6	8	10					
3	30,000	207,195	30,000	2	3	4	6	8	9	10			
4	40,000	182,885	40,000	1	2	3	4	6	8	9	10		
5	50,000	182,775	45,000	1	2	3	4	6	7	8	9	10	
6	60,000	182,775	45,000	1	2	3	4	6	7	8	9	10	
7	70,000	182,775	45,000	1	2	3	4	6	7	8	9	10	
8	80,000	182,775	45,000	1	2	3	4	6	7	8	9	10	

Figure 4-6 and Figure 4-7 graphs show the CML optimisation values calculated for each budget increment against the budget and the RTU actual costs.

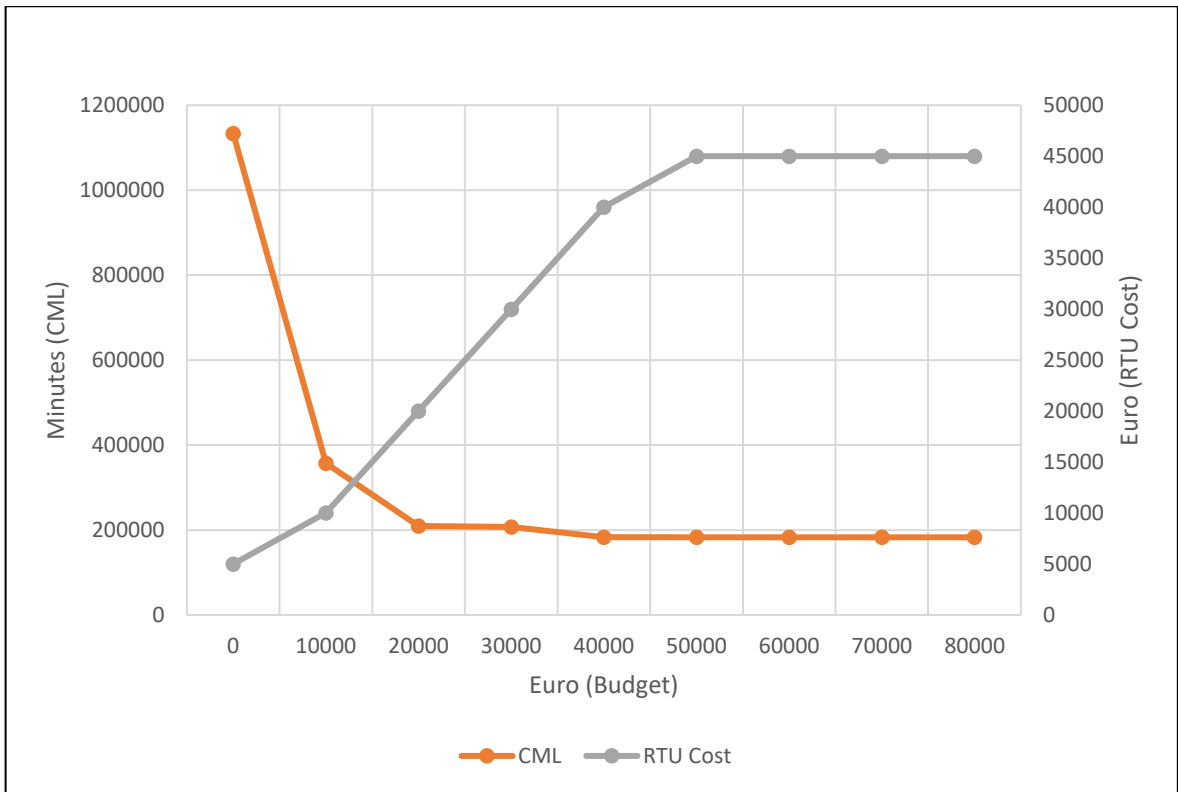

Figure 4-6. Tow-feeders - CML vs RTU Cost for all automated substations considering restrictions

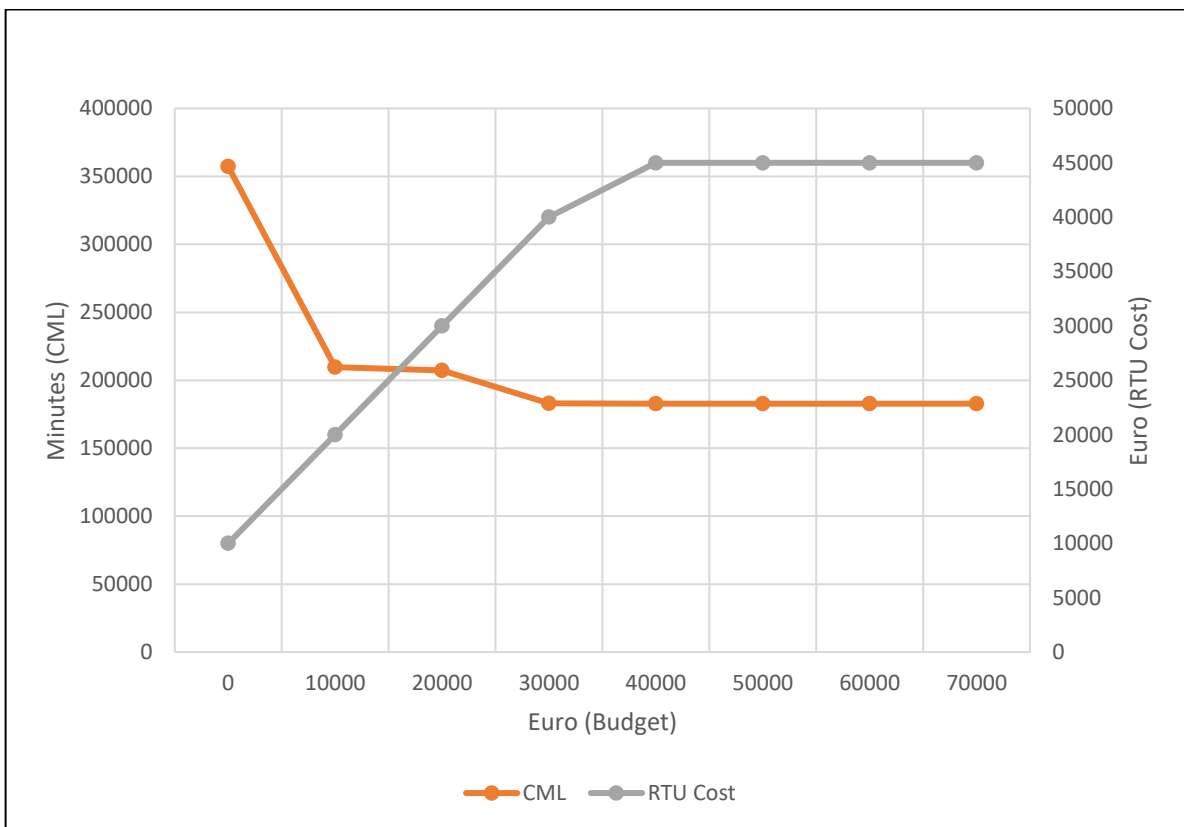

Figure 4-7. Two-feeders - CML vs RTU Cost considering budget only, excluding already automated substations

Comparing the results obtained from the two scenarios, without restrictions and with restrictions, the percentage improvement for each budget increment is presented in Table 4-10.

The percentage improvement is calculated when comparing the CML value between two sequential budgets increments. The percentage change is shown in Figure 4-8.

To highlight this point, one must consider the percentage improvement between SS1 and SS2 for CML without restrictions.

$$CML_{without\ restrictions} = \left( \frac{284025 - 203745}{284025} \right) \times 100 = 28.27\%$$

Table 4-10. CML Percentage improvement between budget increments

Automated substations	CML without restrictions	Improvement %	CML with restrictions	Improvement %
No substations automated	731,100		1,133,500	
Already automated substations	731,100	0.00	1,133,500	0.00
Normally Open Points to automate	730,875	0.03	1,133,045	0.04
1	284,025	61.14	357,215	68.47
2	203,745	28.27	209,555	41.34
3	183,855	9.76	185,245	11.60
4	182,865	0.54	182,885	1.27
5	182,775	0.05	182,775	0.06
6	182,775	0.00	182,775	0.00
7	182,775	0.00	182,775	0.00
8	182,775	0.00	182,775	0.00

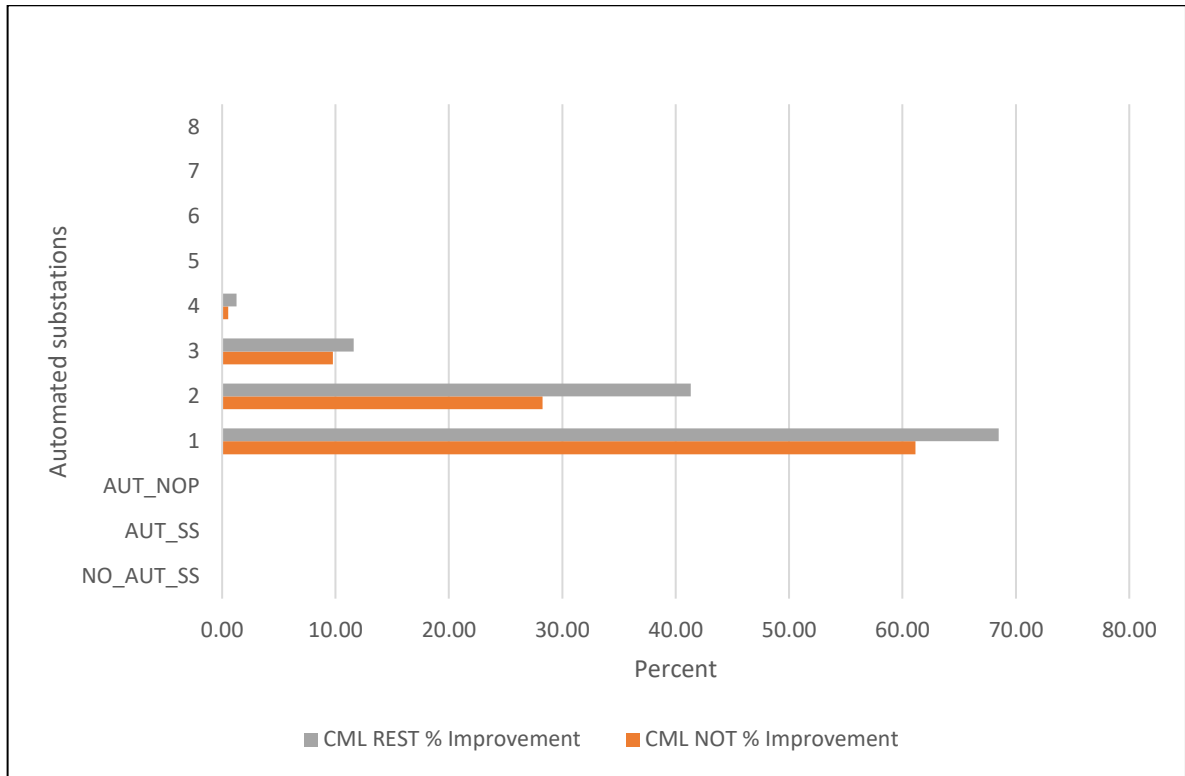

Figure 4-8. Chart for percentage improvement per budget increment

If the CML percentage improvement is calculated using the CML value obtained when no substations are automated against the value obtained for each budget increment CML value, the overall improvement is presented in Table 4-11. Graphically this is shown in Figure 4-9.

To highlight this point, one must consider the percentage improvement between the CML for no automated substations and the CML for SS2.

$$CML_{without\ restrictions} = \left( \frac{731100 - 203745}{731100} \right) \times 100 = 72.13\%$$

Table 4-11. CML improvement, no substations automated against the budget increment

<b>Automated substations</b>	<b>CML without restrictions</b>	<b>Improvement %</b>	<b>CML with restrictions</b>	<b>Improvement %</b>
No substations automated	731,100		1,133,500	
Already automated substations	731,100	0.00	1,133,500	0.00
Normally Open Points to automate	730,875	0.03	1,133,045	0.04
1	284,025	61.15	357,215	68.49
2	203,745	72.13	209,555	81.51
3	183,855	74.85	185,245	83.66
4	182,865	74.99	182,885	83.87
5	182,775	75.00	182,775	83.88
6	182,775	75.00	182,775	83.88
7	182,775	75.00	182,775	83.88
8	182,775	75.00	182,775	83.88

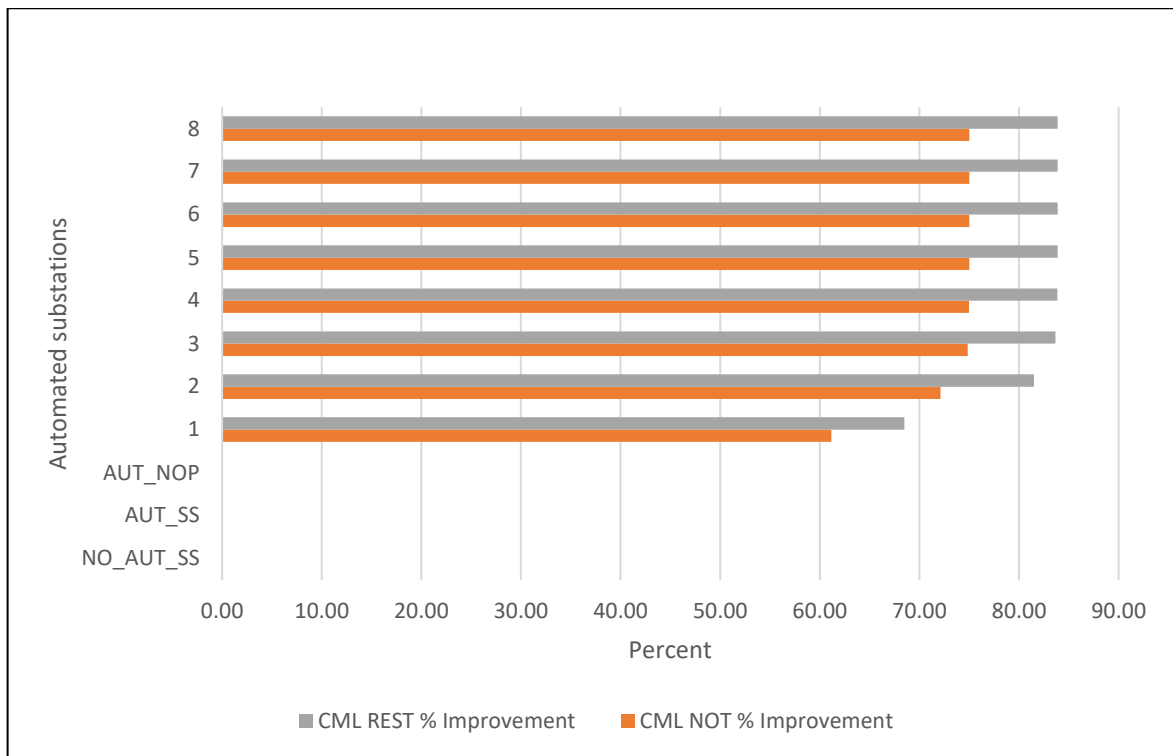

Figure 4-9. CML percentage overall improvement

Both methods used to show the percentage improvement gives the same outcome, i.e., that is the percentage improvement saturates after a few substations have been automated. This means that beyond a certain value, any additional investment done does not reduce the customer minutes lost.

#### 4.8 Four-feeder network with 21 substations

To analyse further and test the algorithm, a four-feeder network was created having one source bus and 20 substations. Data for each substation is based on typical data that can be obtained from DSO networks.

The single line diagram for the four-feeder network is presented in Figure 4-10.

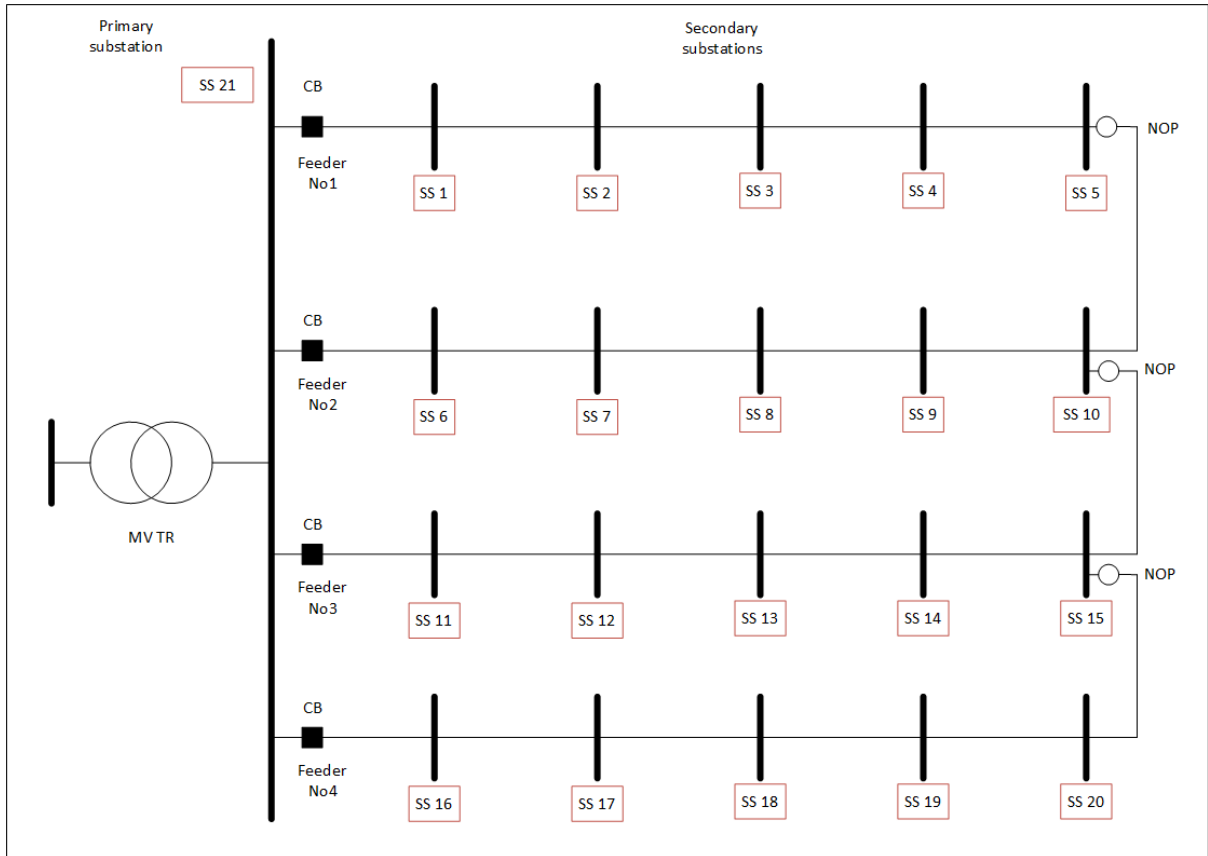

Figure 4-10. Four-feeder network single line diagram

The network data is shown in Table 4-12

Table 4-12. Data for four-feeder network

Information	Data
Budget available	€200,000
Estimated Cost per substation	€10,000
No of substations	10
No of Source Buses	1
No of Feeders	4
No of Automated substations	0
No of Automated Normally Open Points	3



#### 4.8.1 Substations without any restrictions

The network is analysed considering that all substations do not have any operational restrictions. The data is shown in Table 4-13, where the Site Access, Operational Restrictions and Site Location, SAT, ORT and SLT respectively, are set at '0'.

Following the GA optimisation done for the four-feeder network, the optimised locations are presented in Table 4-14 and Table 4-15.

Graphically the optimised CML values, against the budget and RTU actual costs, are presented in Figure 4-11 and Figure 4-12.

Table 4-13. Data for four-feeder networks without restrictions

NODE No	Substation name	Connected Meters Qty	Transformer Rating kVA	Substation Importance SSI	Site Access SAT	Operational Restrictions ORT	Site Location SLT	RTU Type
1	SS 1	221	500	1	0	0	0	0
2	SS 2	201	500	1	0	0	0	1
3	SS 3	220	500	1	0	0	0	2
4	SS 4	1	1000	1	0	0	0	3
5	SS 5	1	500	1	0	0	0	2
6	SS 6	374	500	1	0	0	0	2
7	SS 7	1	500	1	0	0	0	2
8	SS 8	686	500	1	0	0	0	1
9	SS 9	10	250	1	0	0	0	1
10	SS 10	722	1000	1	0	0	0	4
11	SS 11	696	800	1	0	0	0	2
12	SS 12	347	500	1	0	0	0	2
13	SS 13	221	500	1	0	0	0	1
14	SS 14	8	100	1	0	0	0	1
15	SS 15	201	500	1	0	0	0	4
16	SS 16	2	250	1	0	0	0	2
17	SS 17	171	250	1	0	0	0	2
18	SS 18	24	250	1	0	0	0	1
19	SS 19	482	500	1	0	0	0	1
20	SS 20	596	500	1	0	0	0	4

Table 4-14. Results for four-feeder networks without restrictions

<b>Automated substations</b>	<b>Budget Increment (Euro)</b>	<b>Customer Minutes Lost (min)</b>	<b>Actual Cost (Euro)</b>
No substations automated	0	1,555,500	0
Already automated substations	0	1,555,500	0
Normally Open Points to automate	0	1,347,600	13,000
1	10,000	918,525	9,000
2	20,000	619,140	18,000
3	30,000	514,200	29,000
4	40,000	433,920	39,000
5	50,000	409,125	50,000
6	60,000	389,235	60,000
7	70,000	388,965	70,000
8	80,000	388,875	77,000
9	90,000	388,875	77,000
10	100,000	388,875	77,000
11	110,000	388,875	77,000
12	120,000	388,875	77,000
13	130,000	388,875	77,000
14	140,000	388,875	77,000
15	150,000	388,875	77,000
16	160,000	388,875	77,000

Table 4-15. Results for four-feeder networks without restrictions - substations

Automated substations	Substations to automate (Node Number)																
No substations automated	Nil																
Already automated substations	Nil																
Normally Open Points to automate	5, 10, 15																
1	2	8	13														
2	2	8	12	19	20												
3	2	8	11	12	13	18	19	20									
4	2	3	6	8	11	12	13	18	19	20							
5	2	3	6	8	9	11	12	13	14	17	18	19	20				
6	1	2	3	6	8	9	11	12	13	14	17	18	19	20			
7	1	2	3	6	7	8	9	11	12	13	14	16	17	18	19	20	
8	1	2	3	4	6	7	8	9	11	12	13	14	16	17	18	19	20
9	1	2	3	4	6	7	8	9	11	12	13	14	16	17	18	19	20
10	1	2	3	4	6	7	8	9	11	12	13	14	16	17	18	19	20
11	1	2	3	4	6	7	8	9	11	12	13	14	16	17	18	19	20
12	1	2	3	4	6	7	8	9	11	12	13	14	16	17	18	19	20
13	1	2	3	4	6	7	8	9	11	12	13	14	16	17	18	19	20
14	1	2	3	4	6	7	8	9	11	12	13	14	16	17	18	19	20
15	1	2	3	4	6	7	8	9	11	12	13	14	16	17	18	19	20
16	1	2	3	4	6	7	8	9	11	12	13	14	16	17	18	19	20

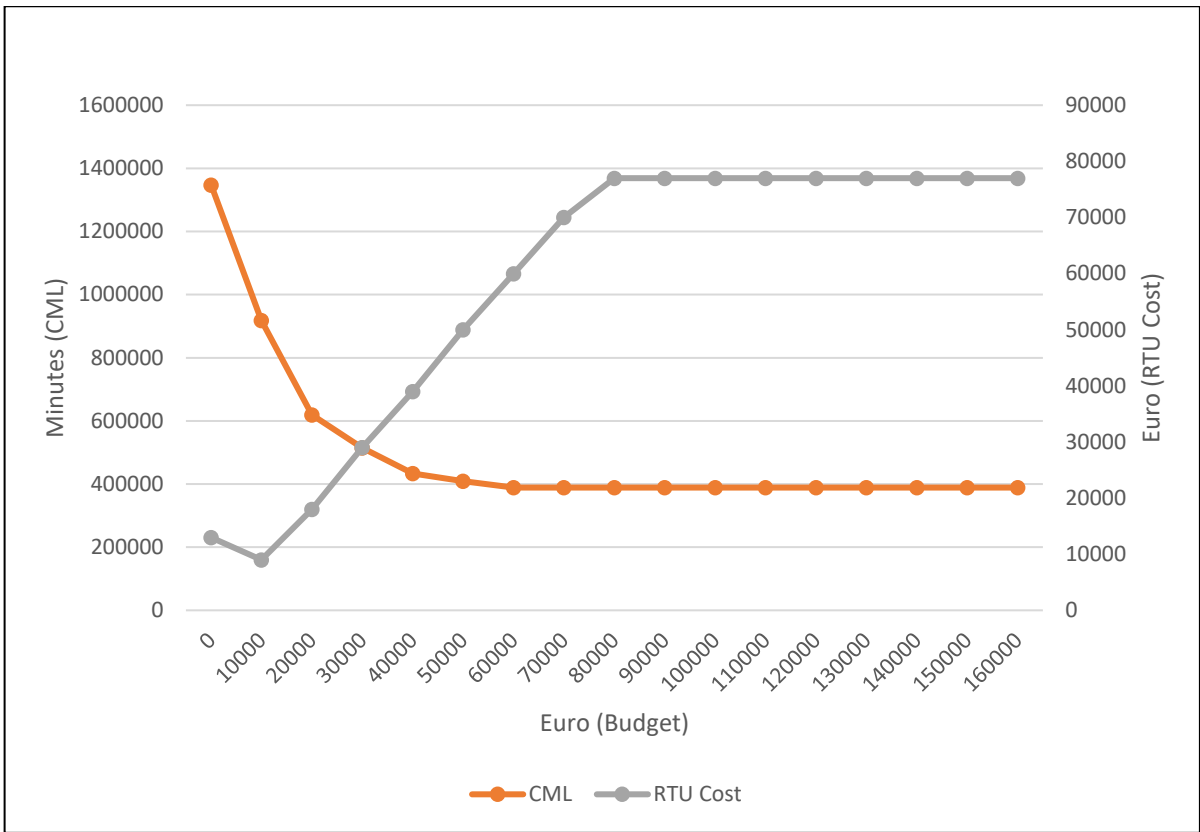

Figure 4-11. Four-feeders - CML vs RTU Cost for all automated substations without restrictions

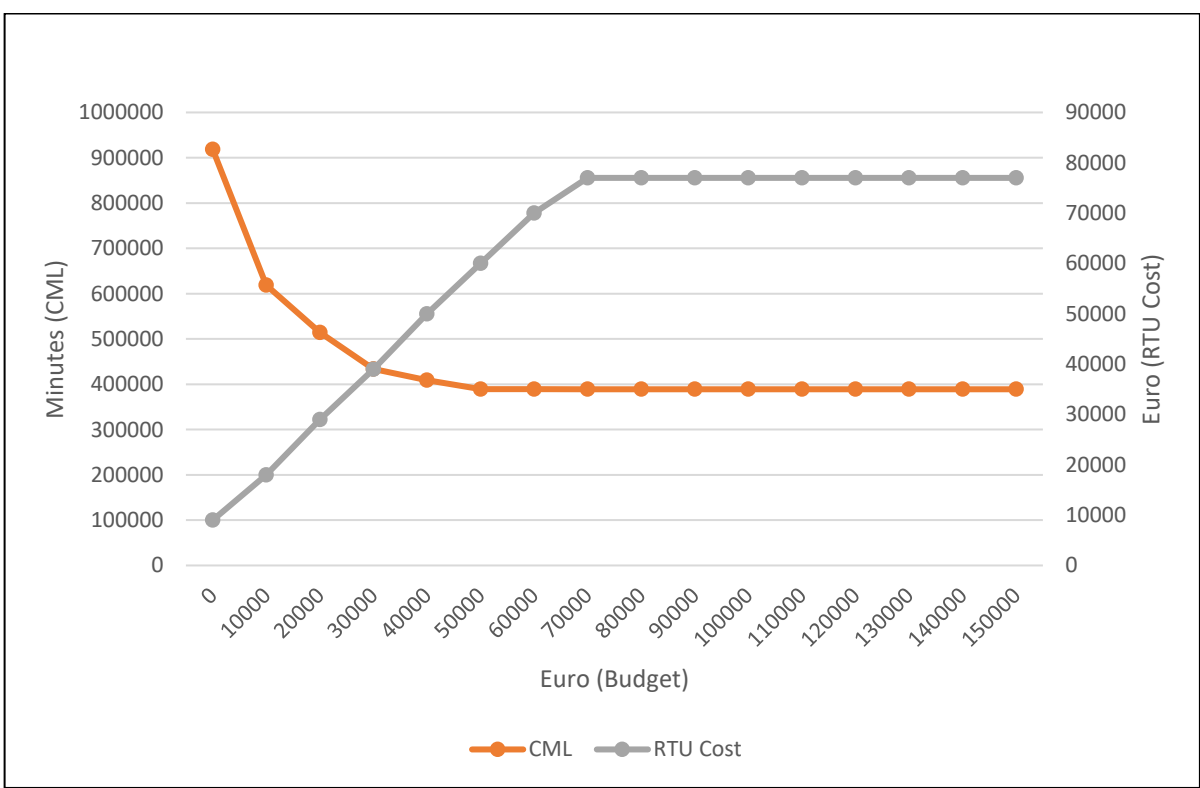

Figure 4-12. Four-feeders - CML vs RTU Cost considering budget only, excluding already automated substations

#### 4.8.2 Substations with restrictions

Each substation is analysed, and any operational restriction, that it may have, is noted. The restrictions are classified under SAT, ORT and SLT, and where applicable these are set at '1'.

Table 4-16 shows the settings for each substation.

The optimised results for the four-feeder network are shown in Table 4-17 and Table 4-18.

Graphically, the optimum CML values are shown in Figure 4-13 and Figure 4-14.

*Table 4-16. Data for four-feeder networks with restrictions*

NODE No	Substation name	Connected Meters Qty	Transformer Rating kVA	Substation Importance SSI	Site Access SAT	Operational Restrictions ORT	Site Location SLT	RTU Type
1	SS 1	221	500	1	0	1	0	0
2	SS 2	201	500	1	0	0	1	1
3	SS 3	220	500	1	0	0	0	2
4	SS 4	1	1000	1	1	1	1	3
5	SS 5	1	500	1	1	0	1	2
6	SS 6	374	500	1	0	0	1	2
7	SS 7	1	500	1	0	1	0	2
8	SS 8	686	500	1	0	1	0	1
9	SS 9	10	250	1	0	0	0	1
10	SS 10	722	1000	1	0	1	0	4
11	SS 11	696	800	1	0	0	0	2
12	SS 12	347	500	1	0	1	1	2
13	SS 13	221	500	1	1	0	1	1
14	SS 14	8	100	1	1	1	1	1
15	SS 15	201	500	1	1	0	1	4
16	SS 16	2	250	1	0	1	1	2
17	SS 17	171	250	1	1	0	1	2
18	SS 18	24	250	1	0	1	1	1
19	SS 19	482	500	1	1	0	1	1
20	SS 20	596	500	1	0	1	1	4

Table 4-17. Results for four-feeder networks with restrictions

<b>Automated substations</b>	<b>Budget Increment (Euro)</b>	<b>Customer Minutes Lost (min)</b>	<b>Actual Cost (Euro)</b>
No substations automated	0	2,815,575	0
Already automated substations	0	2,815,575	0
Normally Open Points to automate	0	2,437,840	13,000
1	10,000	1,389,660	10,000
2	20,000	893,860	19,000
3	30,000	590,225	29,000
4	40,000	466,640	39,000
5	50,000	414,015	50,000
6	60,000	391,785	57,000
7	70,000	389,135	70,000
8	80,000	388,875	77,000
9	90,000	388,875	77,000
10	100,000	388,875	77,000
11	110,000	388,875	77,000
12	120,000	388,875	77,000
13	130,000	388,875	77,000
14	140,000	388,875	77,000
15	150,000	388,875	77,000
16	160,000	388,875	77,000

Table 4-18. Results for four-feeder networks with restrictions - substations

<b>Automated substations</b>	<b>Substations to automate (Node Number)</b>																
No substations automated	Nil																
Already automated substations	Nil																
Normally Open Points to automate	5, 10, 15																
1	8	13	20														
2	2	8	9	13	19	20											
3	2	6	8	12	13	18	19	20									
4	2	6	8	11	12	13	17	18	19	20							
5	2	3	6	8	9	11	12	13	14	17	18	19	20				
6	1	2	3	6	8	9	11	12	13	17	18	19	20				
7	1	2	3	6	7	8	9	11	12	13	14	16	17	18	19	20	
8	1	2	3	4	6	7	8	9	11	12	13	14	16	17	18	19	20
9	1	2	3	4	6	7	8	9	11	12	13	14	16	17	18	19	20
10	1	2	3	4	6	7	8	9	11	12	13	14	16	17	18	19	20
11	1	2	3	4	6	7	8	9	11	12	13	14	16	17	18	19	20
12	1	2	3	4	6	7	8	9	11	12	13	14	16	17	18	19	20
13	1	2	3	4	6	7	8	9	11	12	13	14	16	17	18	19	20
14	1	2	3	4	6	7	8	9	11	12	13	14	16	17	18	19	20
15	1	2	3	4	6	7	8	9	11	12	13	14	16	17	18	19	20
16	1	2	3	4	6	7	8	9	11	12	13	14	16	17	18	19	20

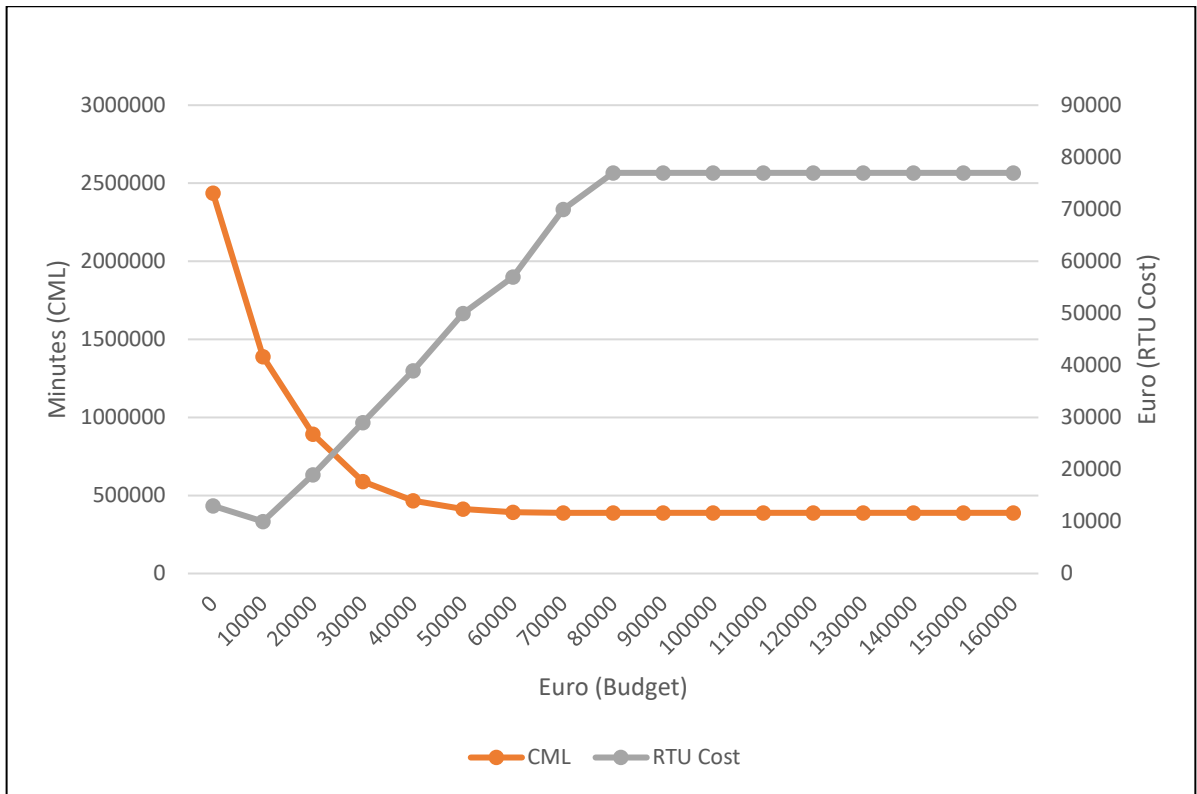

Figure 4-13. Four-feeders - CML vs RTU Cost for all automated substations with restrictions

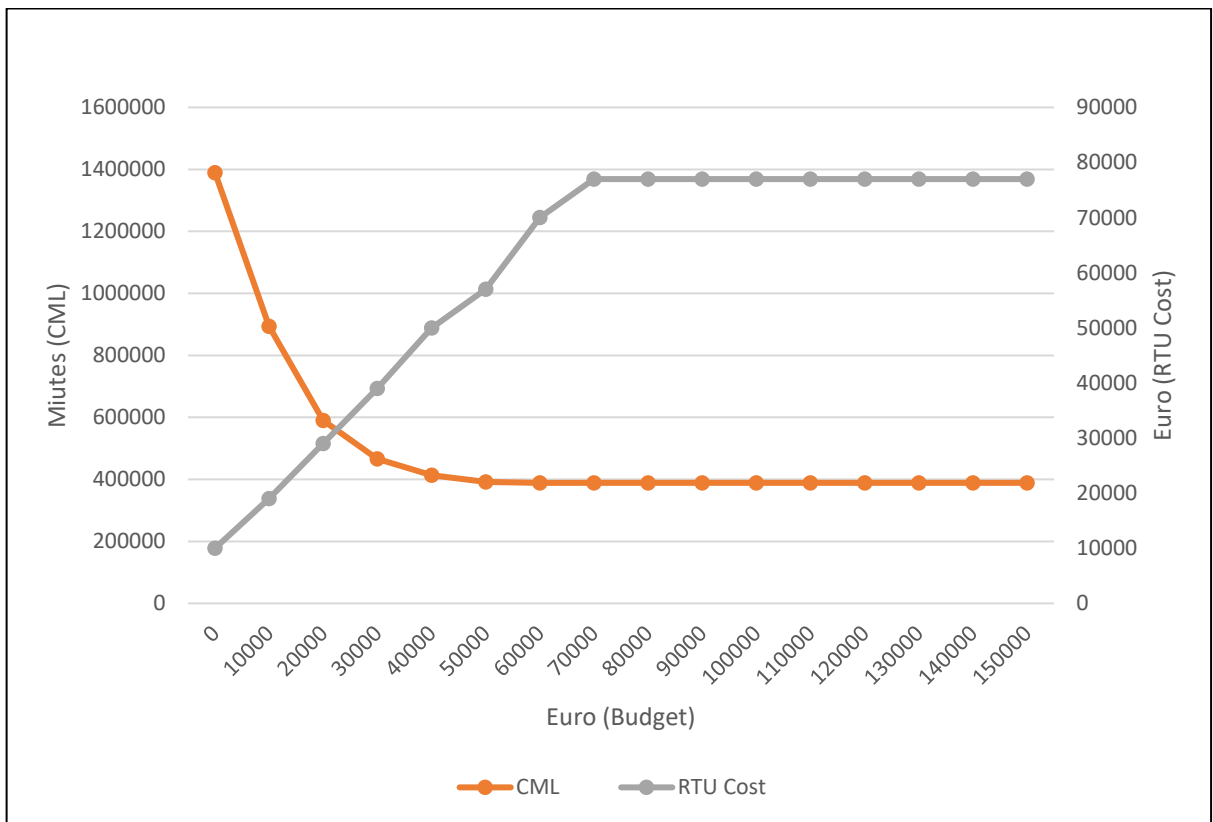

Figure 4-14. Four-feeders - CML vs RTU Cost considering budget only, excluding already automated substations



## 4.9 Summary

As can be seen from the results obtained for the two and four feeders, the method being proposed suggests the optimum number of substations to be automated. These were obtained considering the budget available and the actual cost of the proposed substations RTU. The RTU cost includes the RTU, the related switchgear motors and the required cables.

Two considerations were taken, with without or with restrictions. The restrictions arising from the site, substation location and switchgear operational restrictions were taken into consideration when calculating the time duration required to restore the supply following a fault. The customer minutes lost value will depend on time required to restore the supply back, hence if there are any restrictions these will impact the CML value. The optimum substations locations to be automated depends on the CML value calculated.

The results obtained, shown in Table 4-11, indicate that there will be a substantial improvement in the reduction of customer minutes lost.

Automating only the Normally Open Points improves the CML by 0.03%. However, if more substations are automated the improvement increases and reach 75%. This reduced the CML value from 731100 to 182775 minutes.

The trend in CML reduction and percentage improvement were seen for both when the network did not have any restrictions and when restrictions were applied. This followed for the network scenarios studied, with two and four feeders.

This chapter consolidated the concepts developed in Chapter 3 and developed an optimisation method using the Genetic Algorithm to obtain the optimum reduction in customer minutes lost. The focus was to reduce the customer minutes lost but it did not take into consideration the supply interruption cost. Building on the optimisation methods developed in this chapter, the next chapter will look at the cost of energy not supplied, lost revenue and the return of investment over several years.

## Chapter 5 - Optimum locations using FAIDI and the cost of lost load

The previous chapters presented new concepts and optimisation methods developed to link the site operational experiences to an academic study. The concepts given in Chapter 3 provided the basis for the optimisation method developed in Chapter 4.

Chapter 4 considered the customer minutes lost and the optimisation methodology used provided the optimum substations location that would be ideal/suitable for automation.

Chapter 3, in addition to customer minutes lost and the substation importance, considered the revenue lost as a direct result of an interruption and its duration. The cost concept was brought forward to this chapter and will be used to develop further method for the optimisation of a distribution network.

The methodology used in this chapter will quantify the customer minutes lost for a feeder in terms of financial value using both the energy tariffs and the labour cost. Initially the optimisation method will randomly identify a number of automated substations. The optimisation method will sequentially consider a branch fault within a feeder and the total energy cost is calculated. The optimisation method will then iterate the process and will identify the best locations that give the minimum cost for the lost load.

The transformer rating or the transformer load can be used to quantify the energy not delivered during a supply interruption. When the actual load is not known, the transformer rating can be used to calculate the energy not supplied. However, apart from the transformer rating for each substation, a DSO will have, at least, the peak load for each substation on a seasonal or yearly basis. The peak load can be obtained from the substation main energy meter or otherwise from power meters installed either at the MV side or else at the LV side of the transformer. Where both measurements methods are not available, site readings can be taken. The methodology being presented will consider both the transformer rating and the transformer peak load. Subsequently, these are compared.

A substation can supply separately general consumers, dedicated loads and important customers or a combination of these. In Chapter 3 only one value was given in the substation importance ranking. This did not consider the different type of loads or customers

that are connected which all have their importance. Hence such loads or customers were identified and taken into consideration in the methodology used to calculate the energy not supplied. By this, more weighting was given to the type of customer.

The cost of maintaining the automation equipment and the return on investment will be included later in this chapter to improve the methodology used. All these factors will be used to maximise the investment required through a budget that will be made available by the Distribution System Operator.

When a Distribution System Operator decides to automate substations within its network, there are two scenarios that could be possible. The first one is that the network does not have any substations equipped with automation, hence automation is being introduced for the first time. The second one, is when the network already has some substations already automated and more automated substations are to be added. The research methodology was devised to be able to use in both applications.

## 5.1 System Indices used in power systems

It is necessary to identify which substations are to be automated to increase safety, reduce restoration time, and improve the network performance indices [3], SAIFI, SAIDI and CAIDI.

These three commonly used indices, SAIFI, SAIDI and CAIDI are described below. CAIDI was used in Chapter 3 and since it is directly related to the customer interruption as against the system interruption dealt by SAIFI and SAIDI, will be the foundation for the FAIDI index.

### 5.1.1 SAIFI: System Average Interruption Frequency Index

The SAIFI indicates how often the average customer experiences a sustained interruption over a pre-defined period.

$$SAIFI = \frac{\sum \text{Total Number of Customers Interrupted}}{\text{Total Number of Customers Served}} = \frac{\sum N_i}{N_T} = \frac{CI}{N_T} \quad (14)$$

### 5.1.2 SAIDI: System Average Interruption Duration Index

The SAIDI indicates the total duration of interruption for the average customer during a pre-defined period. It is commonly measured in minutes or hours of interruption.

$$SAIDI = \frac{\sum \text{Customers Minutes of Interruption}}{\text{Total Number of Customers Served}} = \frac{\sum r_i N_i}{N_T} = \frac{CMI}{N_T} \quad (15)$$

### 5.1.3 CAIDI: Customer Average Interruption Duration Index

The CAIDI represents the average time required to restore the service.

$$CAIDI = \frac{\sum \text{Customers Minutes of Interruption}}{\text{Total Number of Customers Interrupted}} = \frac{\sum r_i N_i}{\sum N_i} = \frac{CMI}{CI} = \frac{SAIDI}{SAIFI} \quad (16)$$

Where

- $N_i$      Number of interrupted customers for each sustained interruption event during the reporting period
- $r_i$      Restoration time for each interruption event (sometimes it is given as  $t_i$ )
- $N_T$      Total number of customers served in the area
- $CI$       Customers interrupted
- $CMI$      Customer minutes of interruption or Customer Minutes Lost

Given that Customer Minutes Lost, CML, are being calculated with or without restrictions, then CAIDI can be obtained and used to optimize the network automation. In Figure 5-1 we can see a typical MV feeder, six secondary substations supplied from a primary substation. The feeder has a normally open point, NOP, at substation 7 which is supplied from another

feeder. This means that this NOP can be used to feedback supply to number of substations after the branch fault is located and isolated.

CAIDI is an index that considers the average interruption duration that a customer experiences for a given supply interruption. The interruption could be for one feeder or multiple feeders depending on the location of the fault.

The method being used is considering sequential branch faults for each feeder. For each fault, the customer minutes lost are calculated and cumulatively added for each branch fault. Then CAIDI for all branch faults is obtained. CAIDI could be in minutes or hours.

Looking at each feeder's performance instead of the whole network is an innovative method that will contribute to improvements in the overall network performance. The proposed method directly reflects the affected customers experience and is more representative than network level indices.

#### 5.1.4 FAIDI: Feeder Average Interruption Duration Index

A new index named FAIDI, instead of CAIDI, is presented in a better way to express feeder performance.

$$FAIDI = \frac{\sum \text{Customers Minutes of Interruption}}{\text{Total Number of Feeder Customers Interrupted}} = \frac{\sum r_i N_i}{N_{FT}} = \frac{CML}{FCI} \quad (17)$$

Where

- $N_i$  Number of interrupted customers for each sustained interruption event during the reporting period
- $r_i$  Restoration time for each interruption event (sometimes given as  $t_i$ )
- $N_{FT}$  Total number of customers served from the feeder
- $CML$  Customer minutes of interruption or Customer Minutes Lost

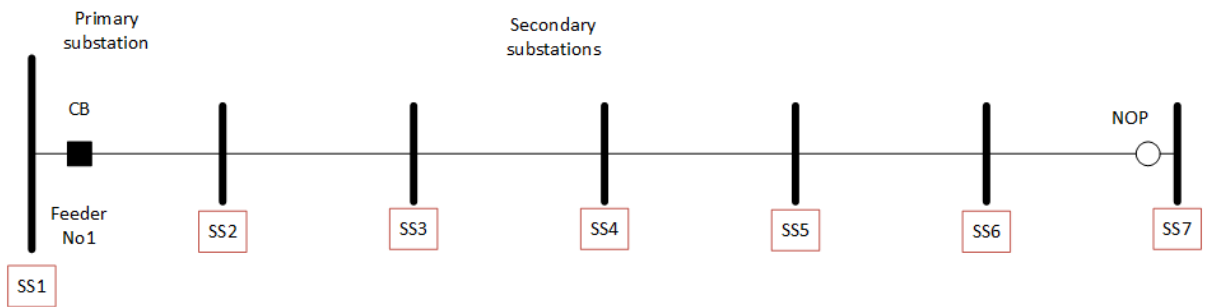

Figure 5-1. MV feeder with only the NOP automated

For each feeder the restoration time for each branch fault is calculated. Initially only the NOP is automated, then automation is added to each substation in turn and a FAIDI is calculated. Consider the feeder shown in Figure 5-1. The evaluation method for each substation, using the feeder process flow shown in Figure 5-2 is as follows:

- 1) For a fault on the downstream cable, the outgoing cable branch between  $SS_n$  and  $SS_{n+1}$ , the feeder will trip from the primary substation
- 2) All substations in this feeder are without supply
- 3) The faulty branch is isolated from the substation under evaluation,  $SS_n$
- 4) Substations from the primary substation down to  $SS_n$ , are switched on back after time  $t_1$
- 5) The faulty branch is isolated from next the downstream substation,  $SS_{n+1}$
- 6) The rest of the substations are switched on back, using then NOP at  $SS_7$ , after time  $t_2$

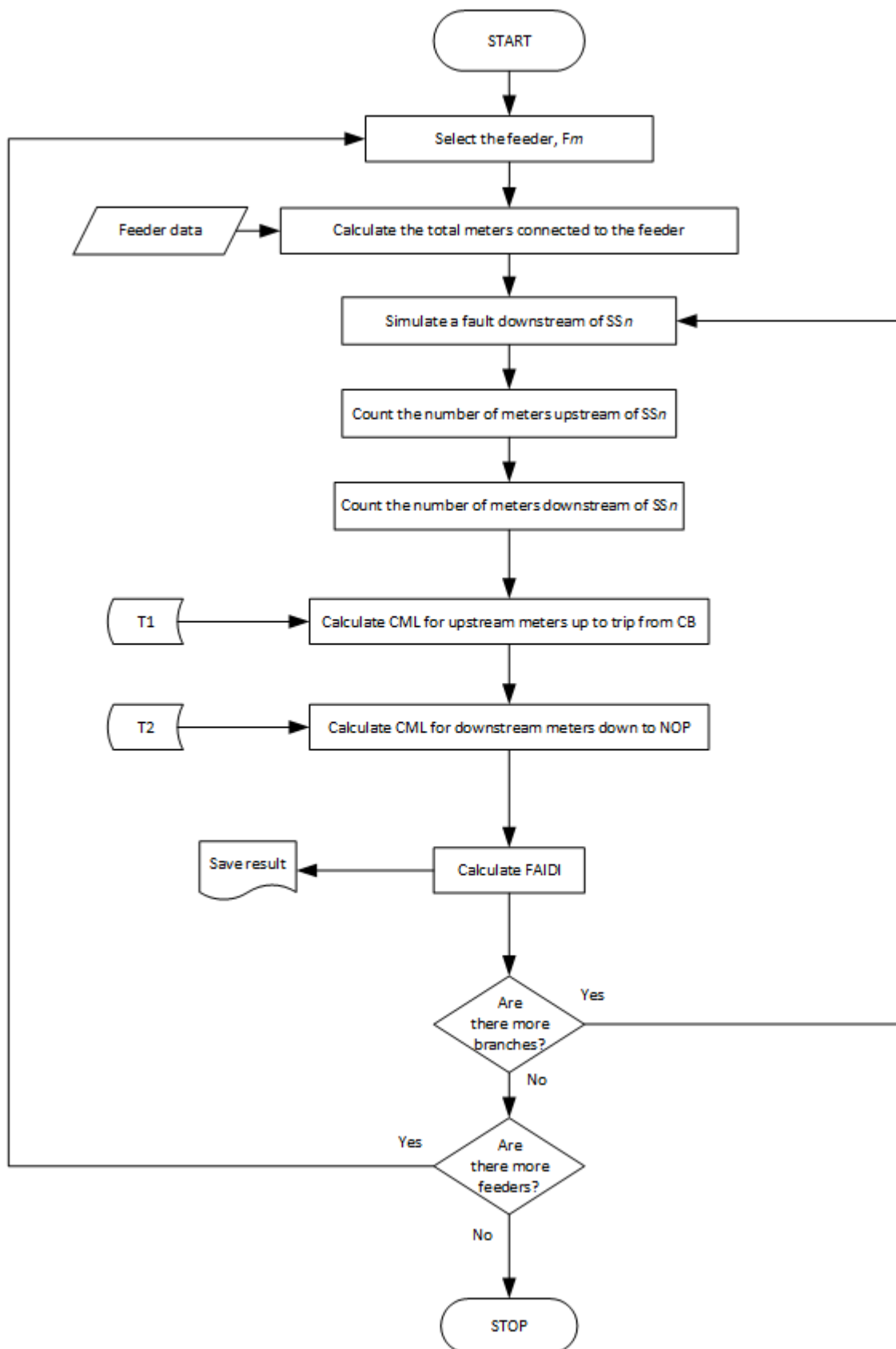

Figure 5-2. Feeder flow chart to compute FAIDI

This was applied to the three network models to check and determine the optimum point between the investment required and the FAIDI achievement. The following results for the two and four-feeder networks show the optimum point for each network.

For the network with two feeders, Table 5-1 shows the results achieved. Graphically the results are given in Figure 5-3 and Figure 5-4. The optimum point is where the FAIDI curve intersects the RTU cost curve. The optimum points are shown to be where the budget available is €30,000, the RTU actual cost is €30,000, exactly within the budget limit and the FAIDI achieved is 75.44 minutes.

Table 5-1. FAIDI results for two-feeder networks

Automated substations	Budget Increment (Euro)	FAIDI (min)	Actual Cost (Euro)	Substations to automate (Node Number)									
No substations automated	0	300	0	Nil									
Already automated substations	0	300	0	Nil									
Normally Open Points to automate	0	299.91	5,000	5									
1	10,000	116.55	10,000	2	8	10							
2	20,000	83.60	20,000	2	3	6	8	10					
3	30,000	75.44	30,000	1	2	3	6	8	10				
4	40,000	75.04	40,000	1	2	3	4	6	8	9	10		
5	50,000	75	45,000	1	2	3	4	6	7	8	9	10	
6	60,000	75	45,000	1	2	3	4	6	7	8	9	10	
7	70,000	75	45,000	1	2	3	4	6	7	8	9	10	
8	80,000	75	45,000	1	2	3	4	6	7	8	9	10	



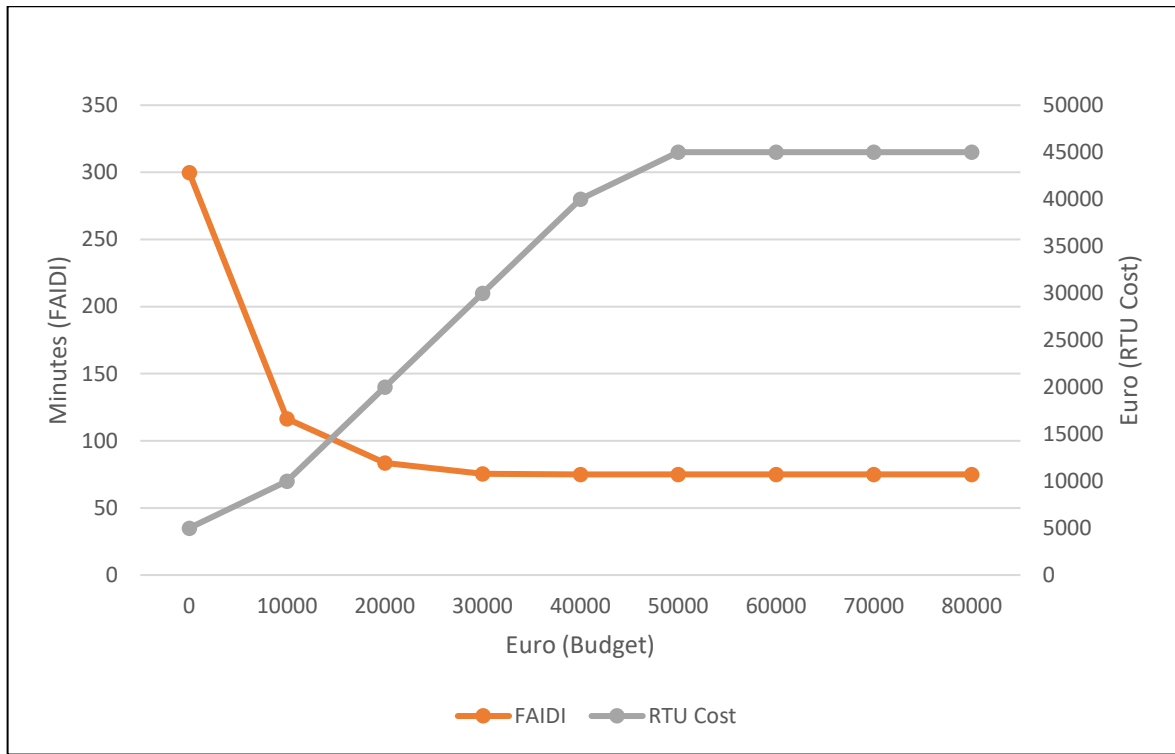

Figure 5-3. Two-feeder - FAIDI vs RTU Cost for all automated substations

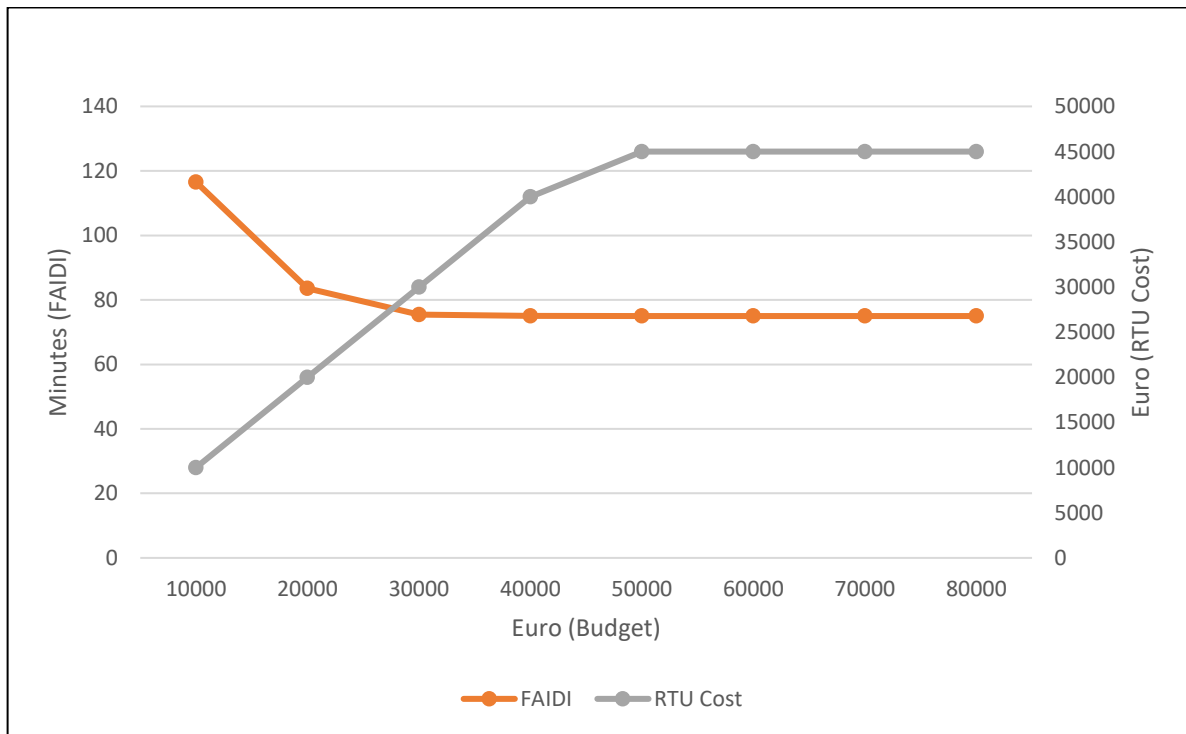

Figure 5-4. Two-feeders - FAIDI vs RTU Cost considering budget only, excluding already automated substations

The results, for the network with four feeders are given in Table 5-2 and Table 5-3 respectively. Graphically the results are shown in Figure 5-5 and Figure 5-7. The optimum point is achieved when FAIDI is 83.69 minutes. This gives about 72% achievement when 65% of the substations are automated.

Table 5-2. FAIDI results for four feeders' networks

<b>Automated substations</b>	<b>Budget Increment (Euro)</b>	<b>FAIDI (min)</b>	<b>Actual Cost (Euro)</b>
No substations automated	0	300	0
Already automated substations	0	300	0
Normally Open Points to automate	0	259.90	13,000
1	10,000	169.60	10,000
2	20,000	119.41	18,000
3	30,000	97.58	28,000
4	40,000	83.69	39,000
5	50,000	78.91	50,000
6	60,000	75.07	60,000
7	70,000	75.02	70,000
8	80,000	75	77,000
9	90,000	75	77,000
10	100,000	75	77,000
11	110,000	75	77,000
12	120,000	75	77,000
13	130,000	75	77,000
14	140,000	75	77,000
15	150,000	75	77,000
16	160,000	75	77,000

Table 5-3. FAIDI substations location for four-feeder networks

Automated substations	Substations to automate (Node Number)																
No substations automated	Nil																
Already automated substations	Nil																
Normally Open Points to automate	5, 10, 15																
1	8	13	20														
2	2	8	12	19	20												
3	2	6	8	11	12	19	20										
4	2	3	6	8	11	12	13	18	19	20							
5	2	3	6	8	9	11	12	13	14	17	18	19	20				
6	1	2	3	6	8	9	11	12	13	14	17	18	19	20			
7	1	2	3	6	7	8	9	11	12	13	14	16	17	18	19	20	
8	1	2	3	4	6	7	8	9	11	12	13	14	16	17	18	19	20
9	1	2	3	4	6	7	8	9	11	12	13	14	16	17	18	19	20
10	1	2	3	4	6	7	8	9	11	12	13	14	16	17	18	19	20
11	1	2	3	4	6	7	8	9	11	12	13	14	16	17	18	19	20
12	1	2	3	4	6	7	8	9	11	12	13	14	16	17	18	19	20
13	1	2	3	4	6	7	8	9	11	12	13	14	16	17	18	19	20
14	1	2	3	4	6	7	8	9	11	12	13	14	16	17	18	19	20
15	1	2	3	4	6	7	8	9	11	12	13	14	16	17	18	19	20
16	1	2	3	4	6	7	8	9	11	12	13	14	16	17	18	19	20

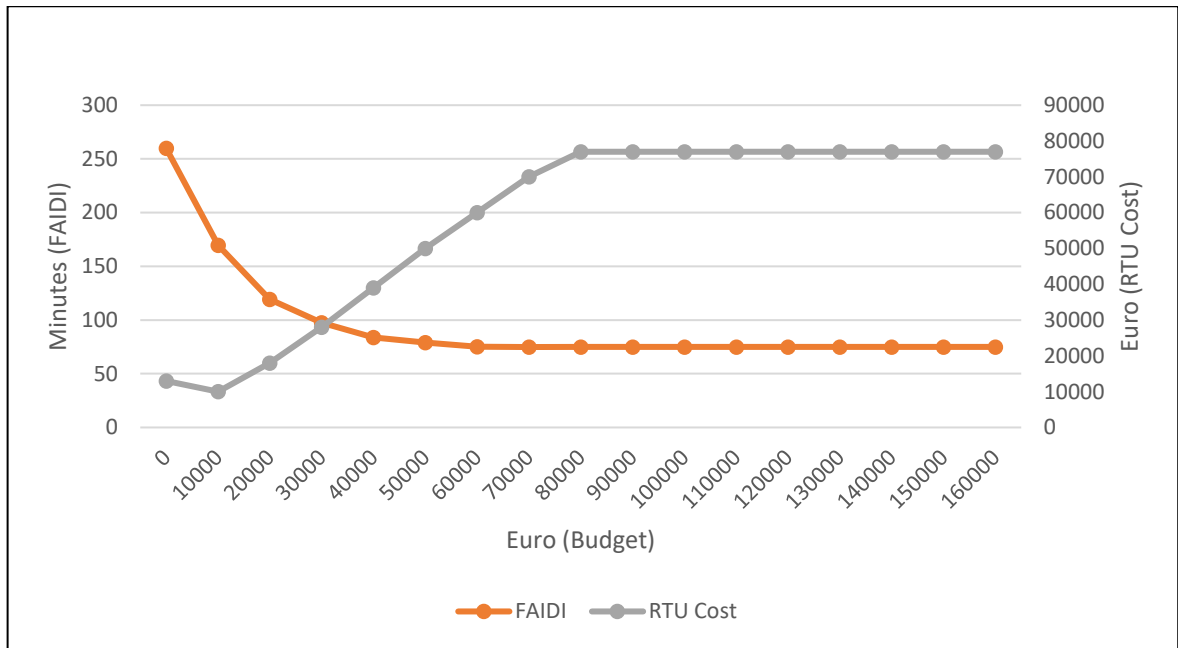

Figure 5-5. Four-feeders - FAIDI vs RTU Cost for all automated substations

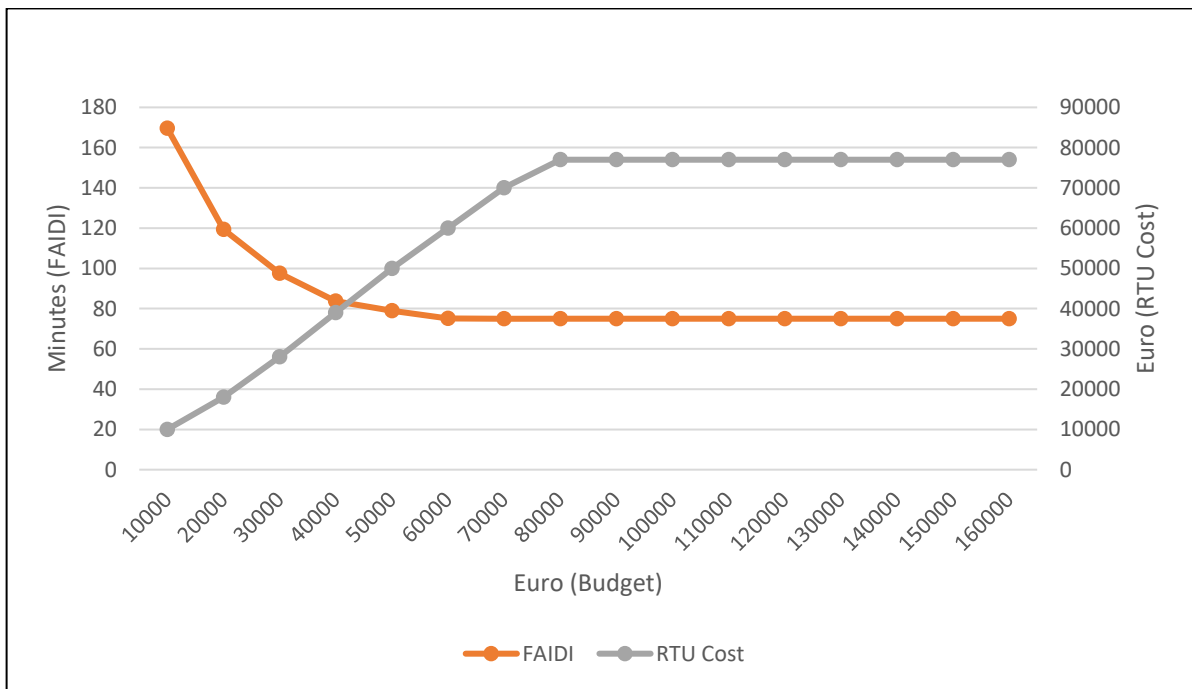

Figure 5-6. Four-feeders - FAIDI vs RTU Cost considering budget only, excluding already automated substations

## 5.2 Cost of Energy not supplied (or Energy Cost)

Combining the outage time which includes restrictions time together with the power that is not supplied during an outage, the cost of energy not supplied can be calculated.

The power not supplied could be obtained from either:

1. the substation transformer rating, say 500kVA, 800kVA, 1000kVA, etc
2. the peak power supplied over one year, quarterly or any period as defined by a DSO
3. actual power at the time of the outage. This is very dynamic and requires real time data from the site and inputting to the model. Hence it will not be considered in this study, but the algorithm can be modified to acquire real time data.

The cost per kWh to calculate the outage cost can be taken considering the following:

1. Energy consumption tariff price per kWh. The tariff is based on the average cost the customer pays per kWh.
2. VOLL, Value of Lost Load per kWh. VOLL reflects the compensation cost to a customer. The value of lost load cost is taken from a research paper [50] and the Great Britain distribution network cost of €4.18/kWh is being used.

For any method used to obtain the power not supplied, a function is used to calculate the energy cost not supplied. The function will also consider the labour cost to restore the supply. The labour cost consists of the hourly rate of an engineer and his assistant and can include the cost of using a vehicle. These costs can vary from one company to another, therefore the method is designed to allow a user to input the labour and other costs as a total cost rate per hour.

When analysing a network to locate the substations that will be suitable for automation, the optimisation method calculates the costs related to each branch fault and obtain the minimum cost after considering several locations. The optimum substation locations will be achieved when the minimum cost for an interruption is reached.

### 5.2.1 Substation transformer rating in kVA

The energy cost per hour for the interrupted duration based on the transformer rating is given by:

$$EC_{NO} = S\left(\frac{T_{NO}}{60}\right)E_p \quad (18)$$

The labour cost per hour for the interrupted duration is given by:

$$LC_{NO} = \left(\frac{T_{NO}}{60}\right)LC_{eng} \quad (19)$$

The same equations will be applied for the restrictions that a substation may have which are SAT, ORT and SLT. These are given by:

$$EC_{SA} = S\left(\frac{T_{SA}}{60}\right)E_p \quad (20)$$

$$LC_{SA} = \left(\frac{T_{SA}}{60}\right)LC_{eng} \quad (21)$$

$$EC_{OR} = S\left(\frac{T_{OR}}{60}\right)E_p \quad (22)$$

$$LC_{OR} = \left(\frac{T_{OR}}{60}\right)LC_{eng} \quad (23)$$

$$EC_{SL} = S\left(\frac{T_{SL}}{60}\right)E_p \quad (24)$$

$$LC_{SL} = \left(\frac{T_{SL}}{60}\right) LC_{eng} \quad (25)$$

Summing up all costs for a substation, one gets

$$TEC_{SS} = EC_{NO} + EC_{SA} + EC_{OR} + EC_{SL} \quad (26)$$

$$TLC_{eng} = LC_{NO} + LC_{SA} + LC_{OR} + LC_{SL} \quad (27)$$

$$ECOST_{frb} = TEC_{SS} + TLC_{eng} \quad (28)$$

These calculations are done for each branch fault considering the proposed substations to be automated given by the GA Optimisation Function.

Therefore, for each branch fault, the restoration time depends on the restrictions that the two substations, upstream (u), and downstream (d), on each side of the fault, may have.

Hence the cost for each branch is given by:

$$TEC_{up} = \sum_{j=1}^n \Sigma S_{up} \left(\frac{T_{NOj}}{60}\right) E_p + \sum_{j=1}^n \Sigma S_{up} \left(\frac{T_{SAju} + T_{ORju} + T_{SLju}}{60}\right) E_p \quad (29)$$

$$TEC_{dw} = \sum_{j=1}^n \Sigma S_{dw} \left(\frac{T_{NOjd}}{60}\right) E_p + \sum_{i=j}^n \Sigma S_{dw} \left(\frac{T_{SAjd} + T_{ORjd} + T_{SLjd}}{60}\right) E_p \quad (30)$$



$$TLC_{up} = \left(\frac{T_{NOju}}{60}\right) LC_{eng} + \left(\frac{T_{SAju} + T_{ORju} + T_{SLju}}{60}\right) LC_{eng} \quad (31)$$

$$TLC_{dw} = \left(\frac{T_{NOjd}}{60}\right) LC_{eng} + \left(\frac{T_{SAjd} + T_{ORjd} + T_{SLjd}}{60}\right) LC_{eng} \quad (32)$$

$$ECOST_{frb} = TEC_{up} + TEC_{dw} + TLC_{up} + TLC_{dw} \quad (33)$$

The objective function for the cost of energy not supplied is given by:

$$\min f = \sum ECOST_{frb} \quad (34)$$

### 5.2.2 Peak power supplied by a substation transformer

The energy cost per hour for the interrupted duration based on the substation transformer peak power is given by:

$$EC_{NO} = P\left(\frac{T_{NO}}{60}\right) E_p \quad (35)$$

The labour cost per hour for the interrupted duration for the interrupted substation is given by:

$$LC_{NO} = \left(\frac{T_{NO}}{60}\right) LC_{eng} \quad (36)$$

Therefore, the same equations, (29) to (33), which are used for the transformer rating, can be used for the transformer peak power.

### 5.3 Two-feeder network with 11 substations

The devised equations were applied to a two-feeder network and the outcome results were evaluated. The analysis was done for both the transformer rating in each substation and for the peak load of each substation. The network was analysed having substations initially without restrictions and then, with some substations having restrictions.

The results obtained, using the transformer rating and the transformer peak load are tabulated below.

#### 5.3.1 Transformer rating in kVA

Table 5-4 and Figure 5-7 are results obtained when the transformer rating in kVA is considered for a network without restrictions.

Table 5-4. Energy Cost results for transformer rating without restrictions

Automated substations	Budget Increment (Euro)	Cost of Energy not supplied (Euro)	Actual Cost (Euro)	Substations to automate (Node Number)									
No substations automated	0	4,450.00	0	Nil									
Already automated substations	0	4,450.00	0	Nil									
Normally Open Points to automate	0	4,350.00	5,000	5									
1	10,000	2,922.50	10,000	2	8	10							
2	20,000	2,517.50	20,000	2	3	6	8	10					
3	30,000	2,292.50	30,000	2	3	4	7	8	9	10			
4	40,000	2,202.50	35,000	2	3	4	6	7	8	9	10		
5	50,000	2,112.50	45,000	1	2	3	4	6	7	8	9	10	
6	60,000	2,112.50	45,000	1	2	3	4	6	7	8	9	10	
7	70,000	2,112.50	45,000	1	2	3	4	6	7	8	9	10	
8	80,000	2,112.50	45,000	1	2	3	4	6	7	8	9	10	

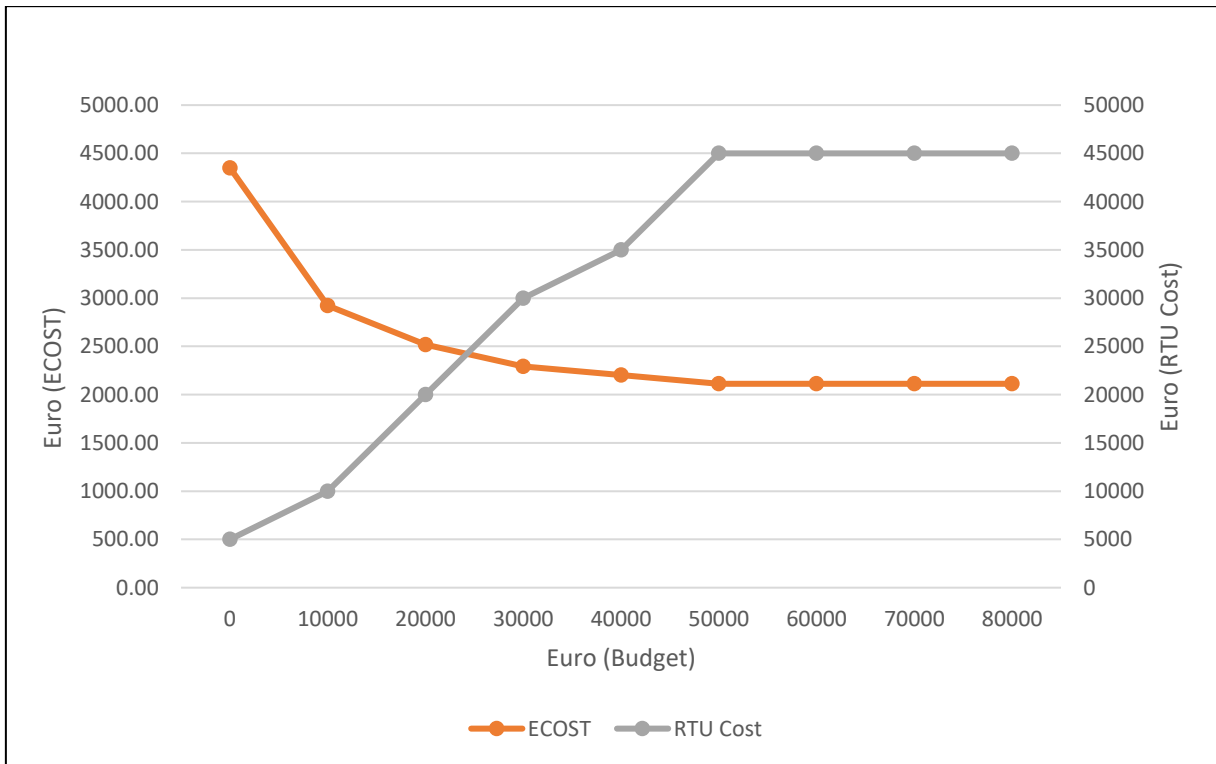

Figure 5-7. Tow-feeders - Transformer rating (kVA) without restrictions

Table 5-5 and Figure 5-8 are the results obtained when the transformer rating in kVA is considered for a network with restrictions.

Table 5-5. Energy Cost results for transformer rating with restrictions

Automated substations	Budget Increment (Euro)	Cost of Energy not supplied (Euro)	Actual Cost (Euro)	Substations to automate (Node Number)									
No substations automated	0	7,157.50	0	Nil									
Already automated substations	0	7,157.50	0	Nil									
Normally Open Points to automate	0	6,827.50	5,000	5									
1	10,000	4,200.00	10,000	2	8	10							
2	20,000	3,355.00	20,000	2	4	8	9	10					
3	30,000	2,875.00	30,000	2	4	6	7	8	9	10			
4	40,000	2,765.00	40,000	1	2	4	6	7	8	9	10		
5	50,000	2,675.00	45,000	1	2	3	4	6	7	8	9	10	
6	60,000	2,675.00	45,000	1	2	3	4	6	7	8	9	10	
7	70,000	2,675.00	45,000	1	2	3	4	6	7	8	9	10	
8	80,000	2,675.00	45,000	1	2	3	4	6	7	8	9	10	

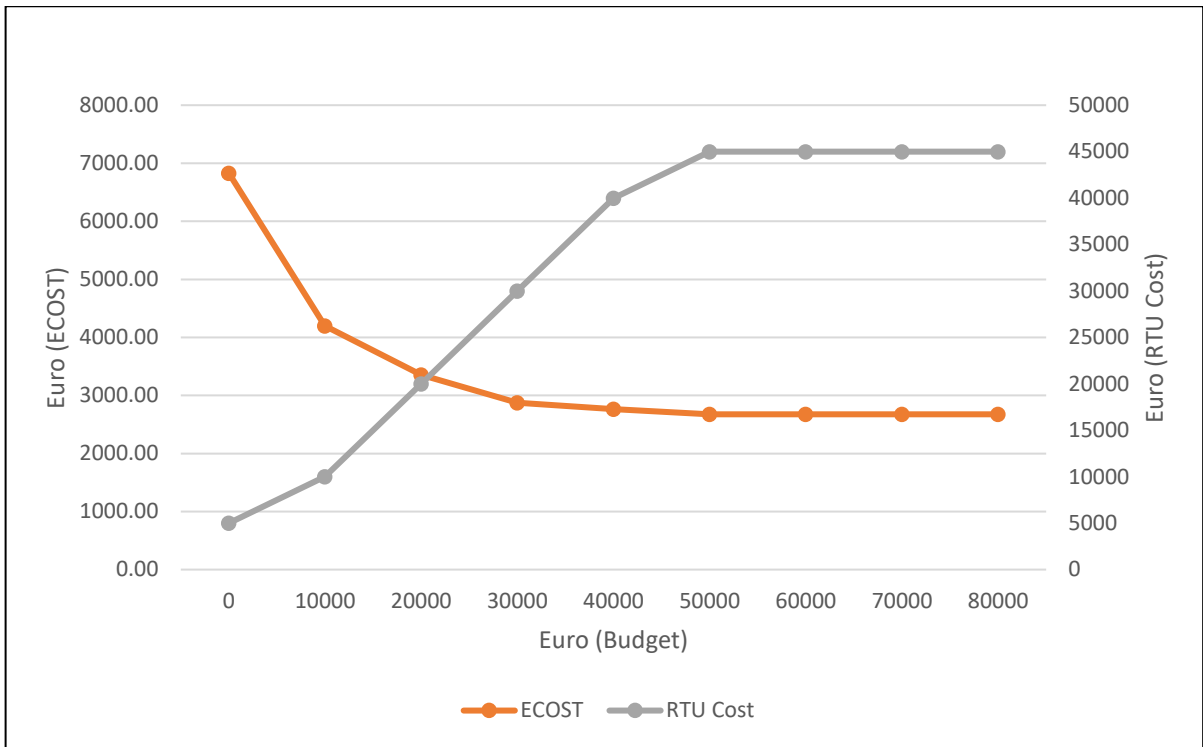

Figure 5-8. Tow-feeders - Transformer rating (kVA) with restrictions

### 5.3.2 Transformer peak loading in kW

Table 5-6 shows the results when the transformer peak power in kW is considered for a network without any restrictions. Figure 5-9 shows graphically the results in Table 5-6.

Table 5-6. Energy Cost results for transformer peak load without restrictions

Automated substations	Budget Increment (Euro)	Cost of Energy not supplied (Euro)	Actual Cost (Euro)	Substations to automate (Node Number)									
				2	3	4	6	7	8	9	10		
No substations automated	0	3,877.00	0	Nil									
Already automated substations	0	3,877.00	0	Nil									
Normally Open Points to automate	0	3,799.50	5,000	5									
1	10,000	2,637.05	10,000	2	8	10							
2	20,000	2,298.65	20,000	2	3	6	8	10					
3	30,000	2,104.25	30,000	2	4	6	7	8	9	10			
4	40,000	2,032.25	35,000	2	3	4	6	7	8	9	10		
5	50,000	1,969.25	45,000	1	2	3	4	6	7	8	9	10	
6	60,000	1,969.25	45,000	1	2	3	4	6	7	8	9	10	
7	70,000	1,969.25	45,000	1	2	3	4	6	7	8	9	10	
8	80,000	1,969.25	45,000	1	2	3	4	6	7	8	9	10	

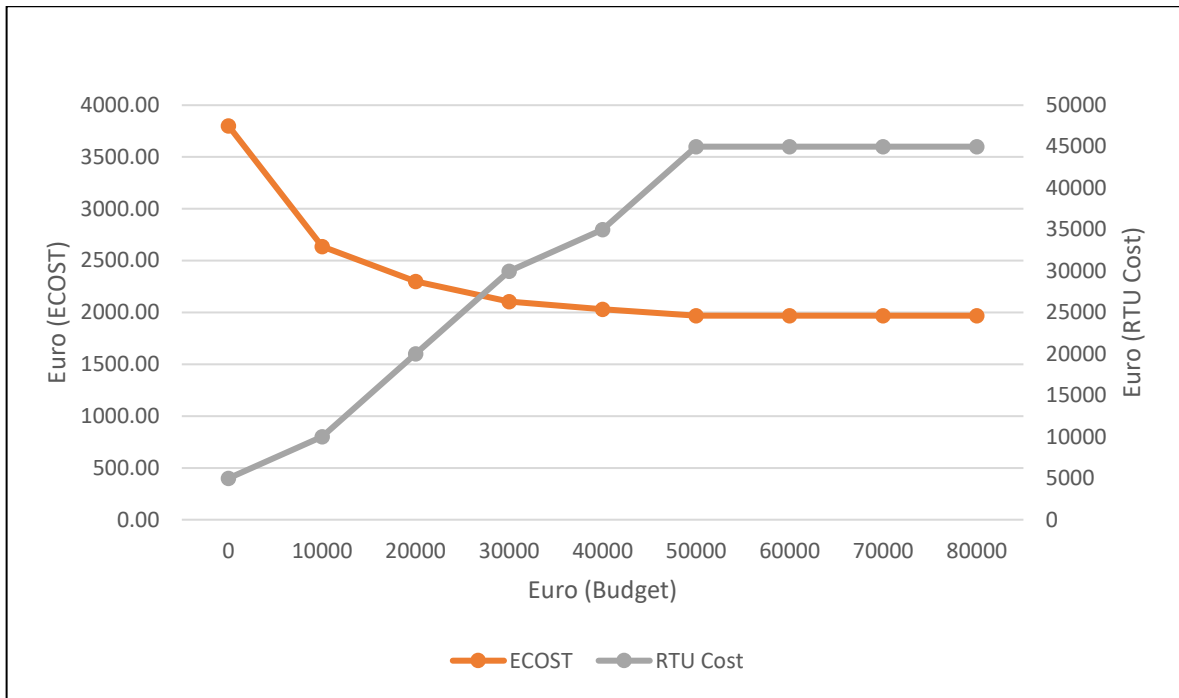

Figure 5-9. Tow-feeders - Transformer peak load (kW) without restrictions

When considering the transformer peak power and the network having some substations with restrictions, the results obtained are given in Table 5-7 and Figure 5-10. The optimum point is achieved when around 50% of the substations are automated resulting in circa 59% reduction in energy cost

Table 5-7. Energy Cost results for transformer peak load with restrictions

Automated substations	Budget Increment (Euro)	Cost of Energy not supplied (Euro)	Actual Cost (Euro)	Substations to automate (Node Number)									
No substations automated	0	6,219.10	0	Nil									
Already automated substations	0	6,219.10	0	Nil									
Normally Open Points to automate	0	5,934.60	5,000	5									
1	10,000	4,486.35	9,000	3	10								
2	20,000	3,096.85	20,000	2	4	8	9	10					
3	30,000	2,680.75	30,000	2	4	6	7	8	9	10			
4	40,000	2,603.75	40,000	1	2	4	6	7	8	9	10		
5	50,000	2,531.75	45,000	1	2	3	4	6	7	8	9	10	
6	60,000	2,531.75	45,000	1	2	3	4	6	7	8	9	10	
7	70,000	2,531.75	45,000	1	2	3	4	6	7	8	9	10	
8	80,000	2,531.75	45,000	1	2	3	4	6	7	8	9	10	



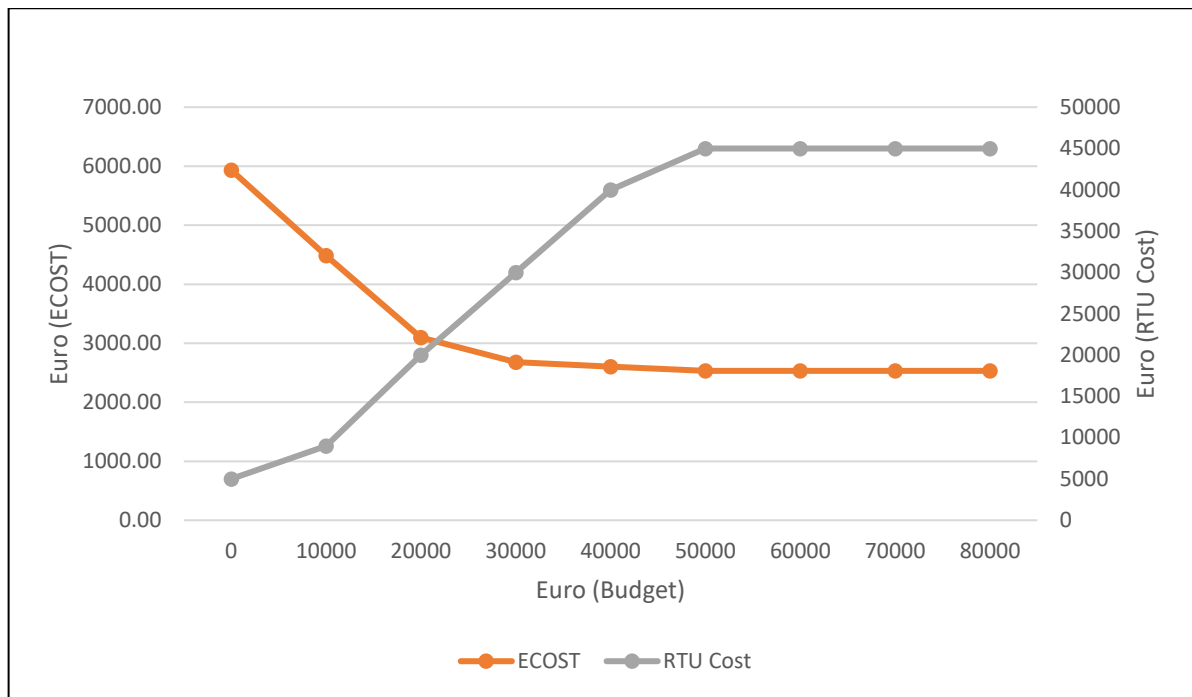

Figure 5-10. Tow-feeders - Transformer peak load (kW) with restrictions

## 5.4 Four-feeder network with 21 substations

Another simulation was done for a four-feeder network. The same analysis was done for the substation transformer rating and then followed by the peak load of each substation.

The results obtained for these simulations are given below.

### 5.4.1 Transformer rating in kVA

For the optimisation done to the network without any restrictions and considering the transformer rating, the results obtained are given in Table 5-8 and Table 5-9, while graphically this is shown in Figure 5-11.

Table 5-8. Energy Cost results for transformer rating without restrictions

<b>Automated substations</b>	<b>Budget Increment (Euro)</b>	<b>Cost of Energy not supplied (Euro)</b>	<b>Actual Cost (Euro)</b>
No substations automated	0	7,940	0
Already automated substations	0	7,940	0
Normally Open Points to automate	0	7,415	13,000
1	10,000	5,827	9,000
2	20,000	5,367	18,000
3	30,000	4,813	29,000
4	40,000	4,498	38,000
5	50,000	4,318	49,000
6	60,000	4,138	59,000
7	70,000	4,048	69,000
8	80,000	3,985	77,000
9	90,000	3,985	77,000
10	100,000	3,985	77,000
11	110,000	3,985	77,000
12	120,000	3,985	77,000
13	130,000	3,985	77,000
14	140,000	7,940	77,000
15	150,000	7,940	77,000
16	160,000	7,415	77,000

Table 5-9. Energy Cost results for transformer rating without restrictions - substations

<b>Automated substations</b>	<b>Substations to automate (Node Number)</b>																
No substations automated	Nil																
Already automated substations	Nil																
Normally Open Points to automate	5, 10, 15																
1	2	8	13														
2	2	7	13	18	20												
3	2	3	8	11	13	18	19	20									
4	2	4	6	8	11	13	17	19	20								
5	2	4	6	7	8	9	11	13	16	18	19	20					
6	2	3	4	6	7	8	9	11	12	13	17	18	19	20			
7	1	2	3	4	6	7	8	9	11	12	13	16	18	19	20		
8	1	2	3	4	6	7	8	9	11	12	13	14	16	17	18	19	20
9	1	2	3	4	6	7	8	9	11	12	13	14	16	17	18	19	20
10	1	2	3	4	6	7	8	9	11	12	13	14	16	17	18	19	20
11	1	2	3	4	6	7	8	9	11	12	13	14	16	17	18	19	20
12	1	2	3	4	6	7	8	9	11	12	13	14	16	17	18	19	20
13	1	2	3	4	6	7	8	9	11	12	13	14	16	17	18	19	20
14	1	2	3	4	6	7	8	9	11	12	13	14	16	17	18	19	20
15	1	2	3	4	6	7	8	9	11	12	13	14	16	17	18	19	20
16	1	2	3	4	6	7	8	9	11	12	13	14	16	17	18	19	20

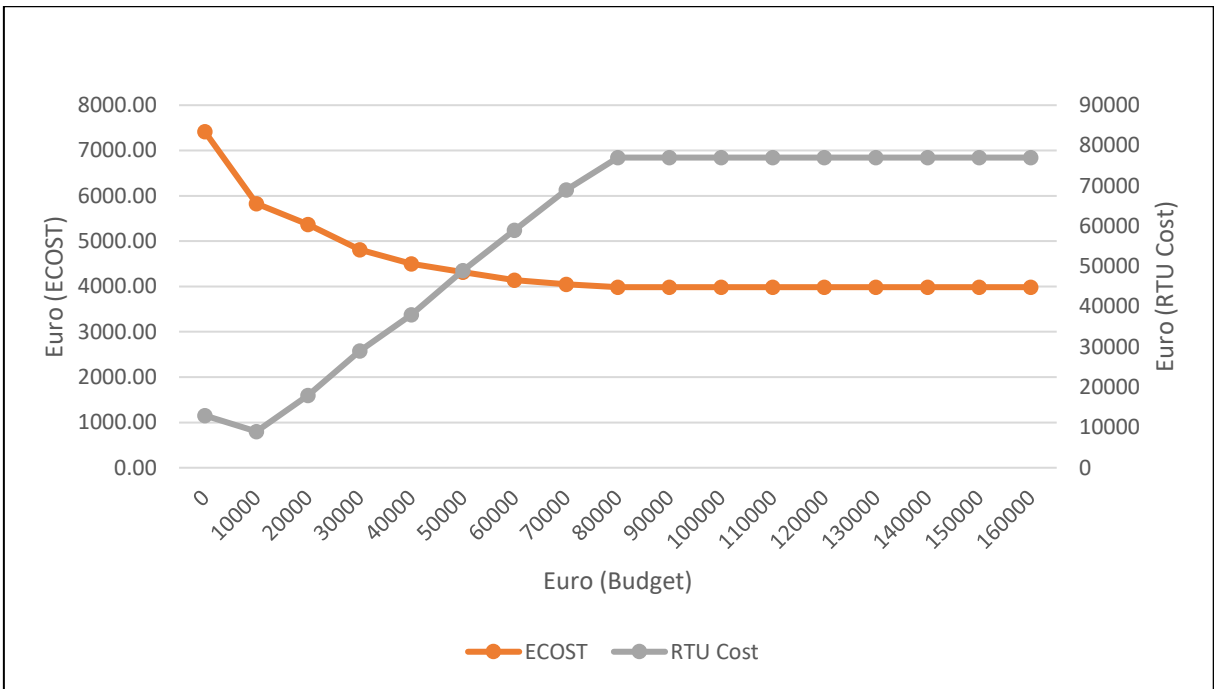

Figure 5-11. Four-feeders - Considering transformer rating (kVA) without restrictions

Subsequently, the optimisation is done for the network having some restrictions and considering the transformer rating. The results are given in Table 5-10 and Table 5-11, while graphically these are shown in Figure 5-12.

Table 5-10. Results for transformer rating with restrictions

<b>Automated substations</b>	<b>Budget Increment (Euro)</b>	<b>Cost of Energy not supplied (Euro)</b>	<b>Actual Cost (Euro)</b>
No substations automated	0	14,243.50	0
Already automated substations	0	14,243.50	0
Normally Open Points to automate	0	12,883.50	13,000
1	10,000	9,645.00	9,000
2	20,000	8,067.50	19,000
3	30,000	7,108.50	28,000
4	40,000	6,376.00	38,000
5	50,000	6,012.00	49,000
6	60,000	5,787.00	59,000
7	70,000	5,645.00	67,000
8	80,000	5,535.00	77,000
9	90,000	5,535.00	77,000
10	100,000	5,535.00	77,000
11	110,000	5,535.00	77,000
12	120,000	5,535.00	77,000
13	130,000	5,535.00	77,000
14	140,000	5,535.00	77,000
15	150,000	5,535.00	77,000
16	160,000	5,535.00	77,000

Table 5-11. Results for transformer rating with restrictions - substations

Automated substations	Substations to automate (Node Number)																
No substations automated	Nil																
Already automated substations	Nil																
Normally Open Points to automate	5, 10, 15																
1	2	8	13														
2	2	8	13	18	19	20											
3	2	4	8	12	13	18	20										
4	2	4	6	8	12	13	17	19	20								
5	2	4	6	8	9	11	12	13	17	18	19	20					
6	2	4	6	7	8	9	11	12	13	16	17	18	19	20			
7	2	3	4	6	7	8	9	11	12	13	14	16	17	18	19	20	
8	1	2	3	4	6	7	8	9	11	12	13	14	16	17	18	19	20
9	1	2	3	4	6	7	8	9	11	12	13	14	16	17	18	19	20
10	1	2	3	4	6	7	8	9	11	12	13	14	16	17	18	19	20
11	1	2	3	4	6	7	8	9	11	12	13	14	16	17	18	19	20
12	1	2	3	4	6	7	8	9	11	12	13	14	16	17	18	19	20
13	1	2	3	4	6	7	8	9	11	12	13	14	16	17	18	19	20
14	1	2	3	4	6	7	8	9	11	12	13	14	16	17	18	19	20
15	1	2	3	4	6	7	8	9	11	12	13	14	16	17	18	19	20
16	1	2	3	4	6	7	8	9	11	12	13	14	16	17	18	19	20

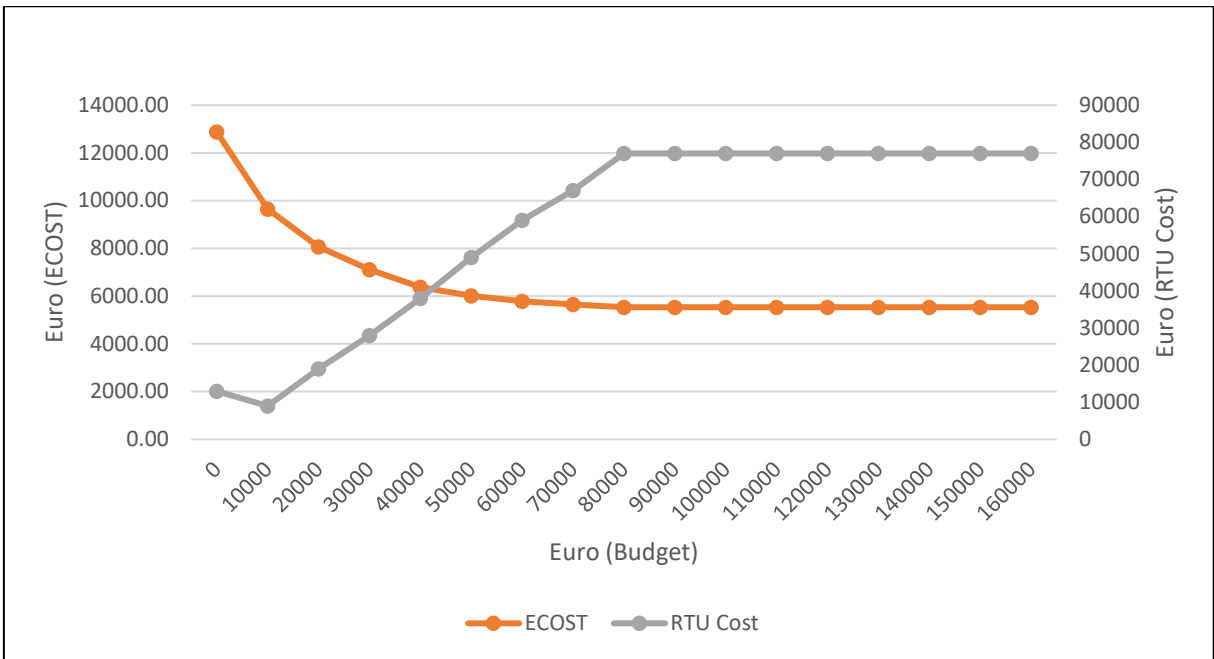

Figure 5-12. Four-feeders - Considering transformer rating (kVA) with restrictions

The results for the network with four feeders, considering the transformer rating, in kVA, indicates that the optimum point is achieved when around 60% of the substations are automated. This results in circa 55% reduction in the energy cost.

#### 5.4.2 Transformer peak loading in kW

The same optimisation method was applied to the network considering the transformer peak power instead of the transformer rating.

Considering the network without any substation restrictions, the results are given in Table 5-12 and Table 5-13. Graphically the results are shown in Figure 5-13.

Table 5-12. Energy Cost results for transformer peak load without restrictions

<b>Automated substations</b>	<b>Budget Increment (Euro)</b>	<b>Cost of Energy not supplied (Euro)</b>	<b>Actual Cost (Euro)</b>
No substations automated	0	6,689.00	0
Already automated substations	0	6,689.00	0
Normally Open Points to automate	0	6,263.00	13,000
1	10,000	5,301.80	10,000
2	20,000	4,631.65	20,000
3	30,000	4,273.45	30,000
4	40,000	4,059.25	40,000
5	50,000	3,909.85	49,000
6	60,000	3,775.75	59,000
7	70,000	3,712.75	69,000
8	80,000	3,672.25	77,000
9	90,000	3,672.25	77,000
10	100,000	3,672.25	77,000
11	110,000	3,672.25	77,000
12	120,000	3,672.25	77,000
13	130,000	3,672.25	77,000
14	140,000	3,672.25	77,000
15	150,000	3,672.25	77,000
16	160,000	3,672.25	77,000



Table 5-13. Energy Cost results for transformer peak load without restrictions - substations

Automated substations	Substations to automate (Node Number)																
No substations automated	Nil																
Already automated substations	Nil																
Normally Open Points to automate	5, 10, 15																
1	3	7															
2	3	8	12	19	20												
3	2	4	7	8	12	19	20										
4	2	4	7	8	11	12	17	19	20								
5	2	4	6	7	8	9	11	13	17	18	19	20					
6	2	3	4	6	7	8	9	11	12	13	17	18	19	20			
7	1	2	3	4	6	7	8	9	11	12	13	17	18	19	20		
8	1	2	3	4	6	7	8	9	11	12	13	14	16	17	18	19	20
9	1	2	3	4	6	7	8	9	11	12	13	14	16	17	18	19	20
10	1	2	3	4	6	7	8	9	11	12	13	14	16	17	18	19	20
11	1	2	3	4	6	7	8	9	11	12	13	14	16	17	18	19	20
12	1	2	3	4	6	7	8	9	11	12	13	14	16	17	18	19	20
13	1	2	3	4	6	7	8	9	11	12	13	14	16	17	18	19	20
14	1	2	3	4	6	7	8	9	11	12	13	14	16	17	18	19	20
15	1	2	3	4	6	7	8	9	11	12	13	14	16	17	18	19	20
16	1	2	3	4	6	7	8	9	11	12	13	14	16	17	18	19	20

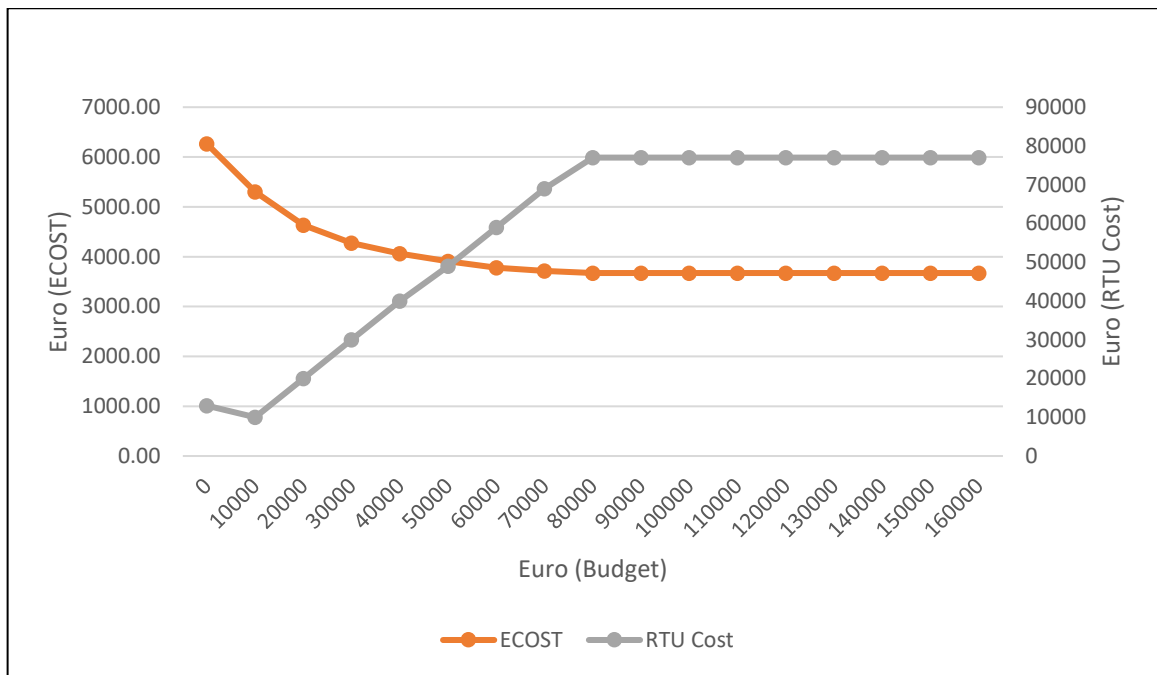

Figure 5-13. Four-feeders - Considering transformer peak load (kW) without restrictions

For the network with restrictions and considering the transformer rating, the results are given in Table 5-14 and Table 5-15. The same results are shown graphically in Figure 5-14.

Table 5-14. Energy Cost results for transformer peak load with restrictions

<b>Automated substations</b>	<b>Budget Increment (Euro)</b>	<b>Cost of Energy not supplied (Euro)</b>	<b>Actual Cost (Euro)</b>
No substations automated	0	11,931.55	0
Already automated substations	0	11,931.55	0
Normally Open Points to automate	0	10,770.90	13,000
1	10,000	8,395.30	9,000
2	20,000	7,183.75	19,000
3	30,000	6,396.40	30,000
4	40,000	5,798.25	38,000
5	50,000	5,655.95	49,000
6	60,000	5,407.55	59,000
7	70,000	5,299.25	67,000
8	80,000	5,222.25	77,000
9	90,000	5,222.25	77,000
10	100,000	5,222.25	77,000
11	110,000	5,222.25	77,000
12	120,000	5,222.25	77,000
13	130,000	5,222.25	77,000
14	140,000	5,222.25	77,000
15	150,000	5,222.25	77,000
16	160,000	5,222.25	77,000

Table 5-15. Energy Cost results for transformer peak load with restrictions - substations

Automated substations	Substations to automate (Node Number)																
No substations automated	Nil																
Already automated substations	Nil																
Normally Open Points to automate	5, 10, 15																
1	2	8	13														
2	2	8	13	18	19	20											
3	2	4	7	12	13	19	20										
4	2	4	6	8	12	13	17	19	20								
5	2	4	7	8	9	11	12	13	17	18	19	20					
6	2	3	4	6	7	8	9	11	12	13	17	18	19	20			
7	2	3	4	6	7	8	9	11	12	13	14	16	17	18	19	20	
8	1	2	3	4	6	7	8	9	11	12	13	14	16	17	18	19	20
9	1	2	3	4	6	7	8	9	11	12	13	14	16	17	18	19	20
10	1	2	3	4	6	7	8	9	11	12	13	14	16	17	18	19	20
11	1	2	3	4	6	7	8	9	11	12	13	14	16	17	18	19	20
12	1	2	3	4	6	7	8	9	11	12	13	14	16	17	18	19	20
13	1	2	3	4	6	7	8	9	11	12	13	14	16	17	18	19	20
14	1	2	3	4	6	7	8	9	11	12	13	14	16	17	18	19	20
15	1	2	3	4	6	7	8	9	11	12	13	14	16	17	18	19	20
16	1	2	3	4	6	7	8	9	11	12	13	14	16	17	18	19	20

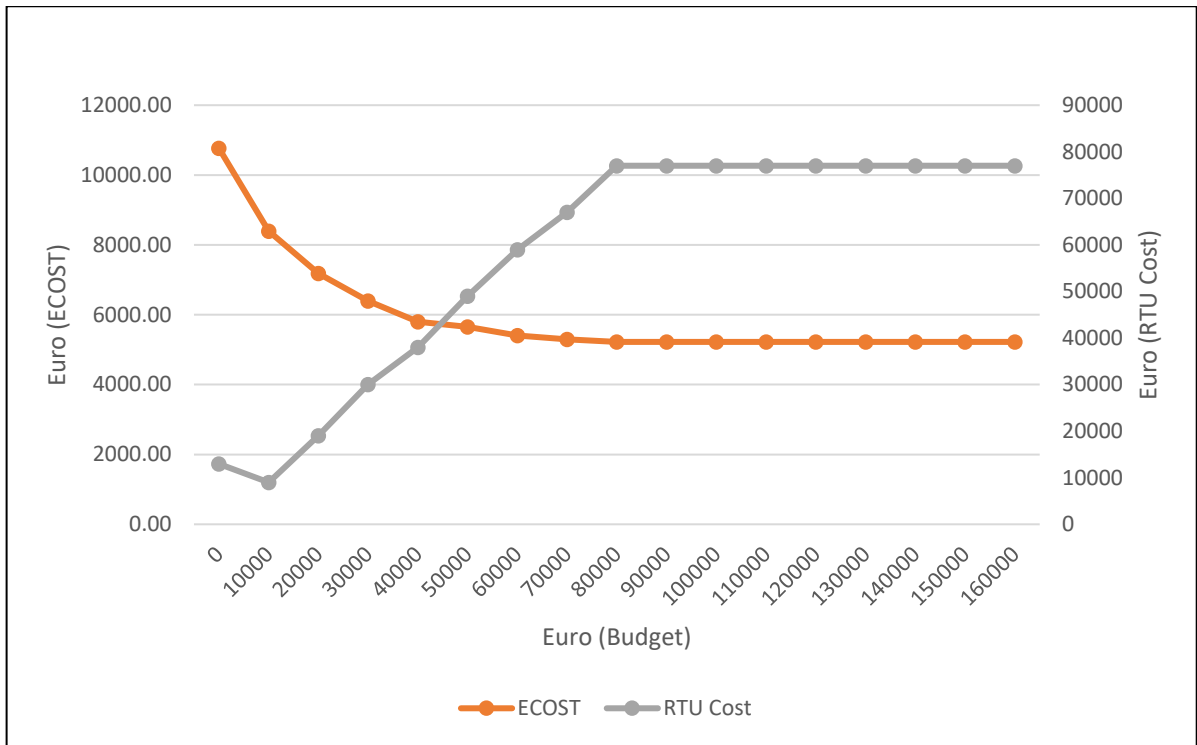

Figure 5-14. Four-feeders - Considering transformer peak load (kW) with restrictions

The results of the network with four feeders, considering the transformer peak power in kW, indicates that the optimum point is achieved when circa 55% of the substations are automated resulting in about 50% reduction in the energy cost.

## 5.5 Substation customer type

There are various types of customers, mainly they can be categorised in residential, commercial, industrial or those of national importance. Each customer may have a specific importance in a distribution network. Such customer importance may vary between one country and another or else between different distribution system operators. Therefore, this must be clearly taken into consideration when analysing a network to obtain the optimum substation locations that can be suitable for automation.

Substations supply loads to different types of customers. The table below shows the type of customers taken into consideration in this research. These may vary from one DSO to another, thus the ranking of importance may change depending on the weighting given to the different customers.

*Table 5-16. Substation Importance ranking*

Substation Importance (SSI)	Description
1	Residential – standard houses, general customers
2	Commercial – shops, shopping malls
3	PV or Wind Farm
4	Industry – factory, Hotels
5	Critical Infrastructure – Military, Police, Civil Protection, Government
6	Hospital, Reverse Osmosis Plant

Substations are given a rank value based on the type of connected customers and their relevant importance. This is determined by the DSO policy. Table 5-16 shows how a typical ranking system can be given to substations based on the connected customers.

Looking at the type of customers given in Table 5-16, shows that important customers with dedicated substations, usually have only one energy meter installed, hence only one

customer is counted. On the other hand, residential substations do have a considerable number of customers.

Dedicated customers having one meter are considered as one customer, therefore those who may be of high importance are not given the required weighting when calculations for customer minutes lost are carried out.

When calculating the CML, a low value for dedicated substations is obtained when compared to residential substations for the same outage time. Looking from the customer's perspective, this does not reflect the real weighting that CAIDI indices will present. As an example, in the case of a hospital it is only one customer, so the calculated CML value will be extremely low, which is not the case when considering the importance of a hospital.

The equations being represented must ensure that the CML is weighted correctly. Therefore, the low value of CML is multiplying the outage time with a power which is equal to the importance ranking value. Hence the weighting of an important customer is reflected much better in the substation location algorithm.

Instead of using the number of connected energy meters, the peak load, in kW, of a substation can be considered. The load will represent better the value of the load lost during an interruption.

## 5.6 Value of Lost Load (VOLL)

The Value of Lost Load per kWh reflects the calculated compensation cost to a customer. The substation importance value given to a substation is used as an index to the substation load, hence this is the weighting given according to the substation importance.

The cost for the value of lost load cost for a few countries is discussed in a research paper [50]. As reported, different countries evaluate the lost load per kWh using a different criterion and hence the value will vary between countries. The method being used in this

research accepts any value hence the same method can be used for different countries. For this analysis, the Great Britain cost price of €4.18 per kWh, is considered.

Using the following equation

$$y = a^b c t \quad (37)$$

Where

*a* This is either the number of customers connected to the substation or the substation peak power

*b* is the value given to the substation importance based on customer importance.

*c* is the cost in Euro

*t* is the outage time in hour

*y* is the value of lost load

So, the value of lost load and the labour cost for a substation with normal operating time is given by

$$VOLL_{NO} = P^{SSI} \left( \frac{T_{NO}}{60} \right) E_p \quad (38)$$

$$LC_{NO} = \left( \frac{T_{NO}}{60} \right) LC_{eng} \quad (39)$$



These calculations are done for each branch fault and considering the proposed substations for automation as given by the GA Optimisation Function.

Therefore, for each branch fault, the restoration time depends on the restrictions that the two substations, upstream (u), and downstream (d), on each side of the fault, may have.

Hence the cost for each branch is given by:

$$VOLL_{up} = \sum_{j=1}^n \sum P_{up}^{SSI} \left( \frac{T_{NOju}}{60} \right) E_p + \sum_{j=1}^n \sum P_{up}^{SSI} \left( \frac{T_{SAju} + T_{ORju} + T_{SLju}}{60} \right) E_p \quad (40)$$

$$VOLL_{dw} = \sum_{j=1}^n \sum P_{dw}^{SSI} \left( \frac{T_{NOjd}}{60} \right) E_p + \sum_{i=1}^n \sum P_{dw}^{SSI} \left( \frac{T_{SAjd} + T_{ORjd} + T_{SLjd}}{60} \right) E_p \quad (41)$$

$$TLC_{up} = \left( \frac{T_{NOju}}{60} \right) LC_{eng} + \left( \frac{T_{SAju} + T_{ORju} + T_{SLju}}{60} \right) LC_{eng} \quad (42)$$

$$TLC_{dw} = \left( \frac{T_{NOjd}}{60} \right) LC_{eng} + \left( \frac{T_{SAjd} + T_{ORjd} + T_{SLjd}}{60} \right) LC_{eng} \quad (43)$$

$$VOLL_{f_{rb}} = VOLL_{up} + VOLL_{dw} + TLC_{up} + TLC_{dw} \quad (44)$$

The objective function for the value of lost load is given by:

$$\min f = \sum VOLL_{frb} \quad (45)$$

The cost value obtained is much higher than that if the substation importance was not considered. The reason is that the substation importance is used as an index to the substation load. The results, using the equations above, for the two- and four-feeder networks are given in Table 5-17, Table 5-18 and Table 5-19 respectively.

The graphs showing when the optimum VOLL values are reached are given in Figure 5-15 and Figure 5-16 respectively.

### 5.6.1 Two-feeder network

Table 5-17. VOLL Results for a two-feeder network

Automated substations	Budget Increment (Euro)	Value of Lost Load (Euro)	Actual Cost (Euro)	Substations to automate (Node Number)									
No substations automated	0	2.60E+17	0	Nil									
Already automated substations	0	2.60E+17	0	Nil									
Normally Open Points to automate	0	2.60E+17	5,000	5									
1	10,000	1.00E+08	11,000	7	8	9							
2	20,000	1.00E+08	21,000	2	3	6	7	8					
3	30,000	35,693.14	30,000	2	3	4	7	8	9	10			
4	40,000	29,548.54	35,000	2	3	4	6	7	8	9	10		
5	50,000	26,866.37	45,000	1	2	3	4	6	7	8	9	10	
6	60,000	26,866.37	45,000	1	2	3	4	6	7	8	9	10	
7	70,000	26,866.37	45,000	1	2	3	4	6	7	8	9	10	
8	80,000	26,866.37	45,000	1	2	3	4	6	7	8	9	10	

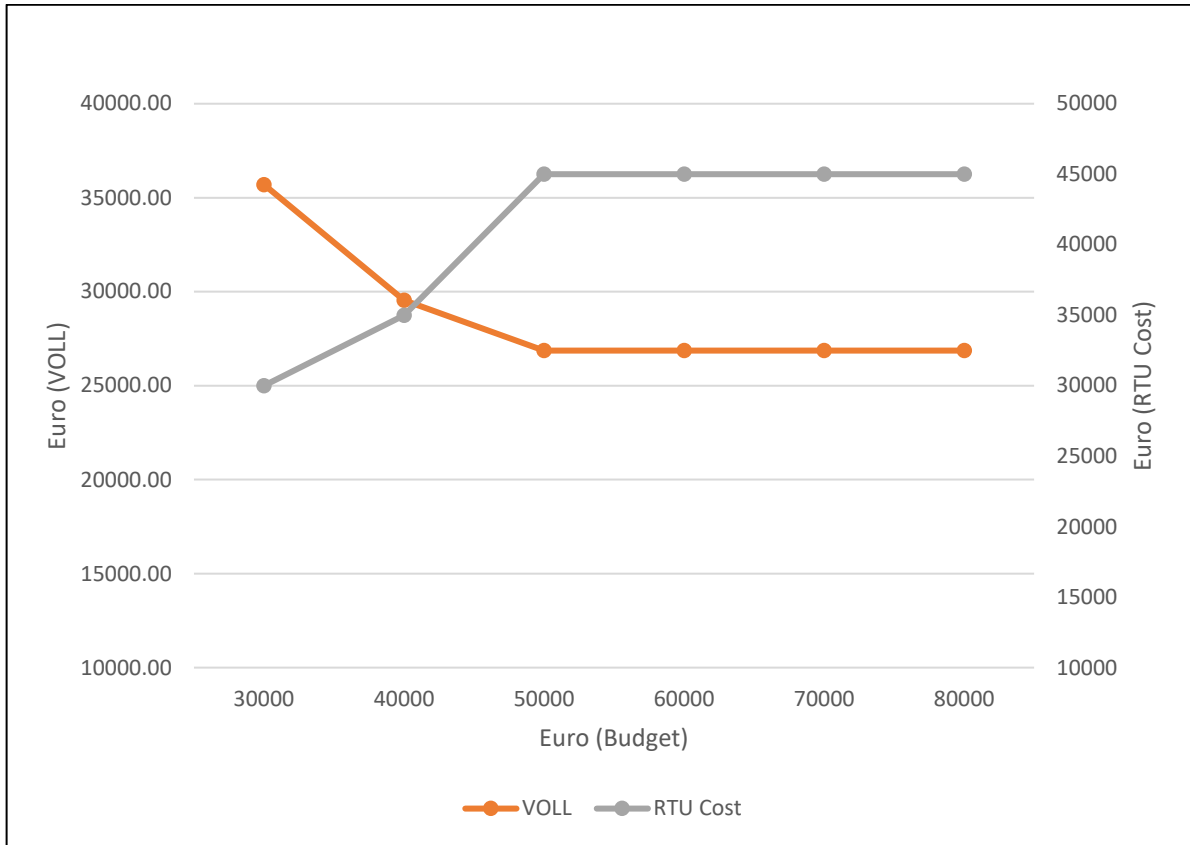

Figure 5-15. Tow-feeders - VOLL results when optimum values are reached

## 5.6.2 Four-feeder network

Table 5-18. VOLL Results for a four-feeder network

Automated substations	Budget Increment (Euro)	Value of Lost Load (Euro)	Actual Cost (Euro)
No substations automated	0	2.60E+17	0
Already automated substations	0	2.60E+17	0
Normally Open Points to automate	0	2.60E+17	13,000
1	10,000	1.00E+08	11,000
2	20,000	1.00E+08	21,000
3	30,000	1.00E+08	31,000
4	40,000	1.00E+08	41,000
5	50,000	71,447.28	47,000
6	60,000	54,326.69	57,000
7	70,000	51,644.52	67,000
8	80,000	44,883.37	77,000
9	90,000	44,883.37	77,000
10	100,000	44,883.37	77,000
11	110,000	44,883.37	77,000
12	120,000	44,883.37	77,000
13	130,000	44,883.37	77,000
14	140,000	44,883.37	77,000
15	150,000	44,883.37	77,000
16	160,000	44,883.37	77,000

Table 5-19. VOLL for a four-feeder network – selected substations

Automated substations	Substations to automate (Node Number)																
No substations automated	Nil																
Already automated substations	Nil																
Normally Open Points to automate	5, 10, 15																
1	8	9	17														
2	2	6	7	16	19												
3	1	2	3	6	14	17											
4	2	3	6	7	8	9	11	17	18	20							
5	2	3	4	7	8	9	13	14	16	18	19	20					
6	2	3	4	6	7	8	9	12	13	14	16	18	19	20			
7	1	2	3	4	6	7	8	9	12	13	14	16	18	19	20		
8	1	2	3	4	6	7	8	9	11	12	13	14	16	17	18	19	20
9	1	2	3	4	6	7	8	9	11	12	13	14	16	17	18	19	20
10	1	2	3	4	6	7	8	9	11	12	13	14	16	17	18	19	20
11	1	2	3	4	6	7	8	9	11	12	13	14	16	17	18	19	20
12	1	2	3	4	6	7	8	9	11	12	13	14	16	17	18	19	20
13	1	2	3	4	6	7	8	9	11	12	13	14	16	17	18	19	20
14	1	2	3	4	6	7	8	9	11	12	13	14	16	17	18	19	20
15	1	2	3	4	6	7	8	9	11	12	13	14	16	17	18	19	20
16	1	2	3	4	6	7	8	9	11	12	13	14	16	17	18	19	20

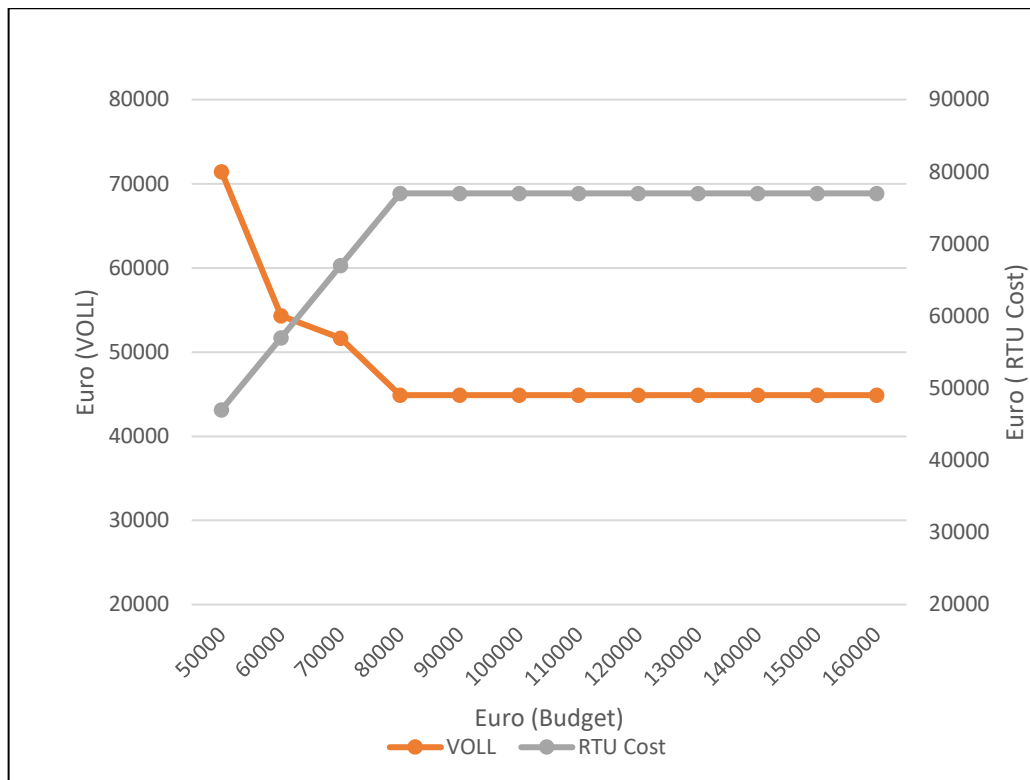

Figure 5-16. Four-feeders - VOLL results when optimum values are reached

## 5.7 Automation cost, maintenance cost and budget availability

For the following analysis, the cost of automation is considered together with the budget available.

The cost considered can be:

- a) Fixed and equal for any type of substation.

or

- b) The cost of automation varies according to the switchgear type.

The budget available could be enough to cover all substations that require automation in the first year or else a yearly budget that can sustain only a small number of substations.

If the cost of to install an RTU and motorised equipment to the existing switchgear in a substation is not known, a fixed cost can be taken for all types of switchgear. This can hold if the project is still in the initial stages. However, DSOs do have an ongoing communication with the switchgear manufacturers, so getting a typical cost for each type of switchgear is possible. If this is so then, the DSO, can set an overall cost according to the type of switchgear. Doing so, a DSO can utilise much better the budget available and will improve the benefits from the substation automation project with the method being proposed in this study.

Maintenance cost for automation will be included and this will be spread over several years. The number of years can be set by the DSO and it is taken on the expected lifetime of the equipment. For instance, 15 years can be a considered.

The Interest Rate, IR, is taken as 8% [51]. This is used to obtain the discount annual cost to the present value.

The maintenance cost is taken as a percentage of the initial capital cost of the switch automation cost. For this analysis, this is taken as 2% of the total capital cost required to automate a substation [51].

### 5.7.1 Return of Investment (RoI)

The capital cost required to automate several substations is an investment required in an MV network. This investment is necessary to reduce the restoration time following a fault in part of the MV network. The investment cost must be compared with the cost lost for the duration of an outage experienced by customers.

In previous methods the cost of an outage was calculated based either on the transformer rating or on the peak load of a transformer for each substation. Both power values can be used but since the peak load, in kW, gives a better solution to the actual load lost, the peak load is used in the method being proposed.

Return of Investment [52], [53], [54], RoI, is different from the term Return on Investment, ROI. RoI considers the investment required and the return of the same investment. This means the return of the capital being invested. ROI considers the return achieved on the investment done, usually a percentage of the investment.

Given that by investing in substation automation, a DSO expects that outage time is reduced and hence cost of energy lost is reduced, then Return of Investment method is more appropriate for such capital cost investment.

The GA method is looking, each time, at several proposed automated substations, so, RoI is used and the optimum value obtained indicates the substation locations where optimisation can be achieved.

The return of investment will consider the cost of energy not supplied together with the maintenance cost for the automation, SWMC, against the investment capital cost of automation, SWCC. Both the cost of energy and the maintenance cost must be considered for several years, practically this is the expected lifetime of the equipment.

The optimum solution is when the RoI value changes from a positive to a negative value. A negative value indicates that the investment done has reduced the cost of lost load, together with the maintenance cost, to an extent that the investment cost is feasible.

$$RoI = \frac{(ECOST_y + SWMC_y) - SWCC_n}{1 + SWCC_n} \quad (46)$$

where

$$ECOST_y = ECOST_{frb} \left[ \frac{1}{(1+IR)^y} \right] \quad (47)$$

and

$$SWMC_y = [SWCC_n \cdot 2\% ] \cdot \left[ \frac{1}{(1 + IR)^y} \right] \quad (48)$$



Note: the '1' in the denominator is used to avoid division by zero when there are no automated substations. The cost of a switch is in thousand euros, so added another euro does not make any difference in calculations.

The objective function for the Return of Investment is given by:

$$\min f = RoI \quad (49)$$

The method is applied to different types of networks, having two, three and four feeders.

The results from the two- and four-feeders networks are given below.

### 5.7.2 Two-feeder network

The results obtained for a two-feeder network are given in Table 5-20 and these are shown graphically in Figure 5-17 and Figure 5-18.

Figure 5-19 shows how the Return of Investment varies against the cost of RTU required for the selected substations. The optimum point is when the cost of RTUs is €30,000 having seven automated substations.

Table 5-20. RoI results for two-feeder networks

Automated substations	Budget Increment (Euro)	RoI (Euro)	Actual Cost (Euro)	Substations to automate (Node Number)									
No substations automated	0	57,490.83	0	Nil									
Already automated substations	0	57,490.83	0	Nil									
Normally Open Points to automate	0	10.16	5,000	5									
1	10,000	1.52	10,000	2	8	10							
2	20,000	0.33	20,000	2	4	8	9	10					
3	30,000	-0.11	30,000	2	4	6	7	8	9	10			
4	40,000	-0.28	40,000	1	2	4	6	7	8	9	10		
5	50,000	-0.35	45,000	1	2	3	4	6	7	8	9	10	
6	60,000	-0.35	45,000	1	2	3	4	6	7	8	9	10	
7	70,000	-0.35	45,000	1	2	3	4	6	7	8	9	10	
8	80,000	-0.35	45,000	1	2	3	4	6	7	8	9	10	

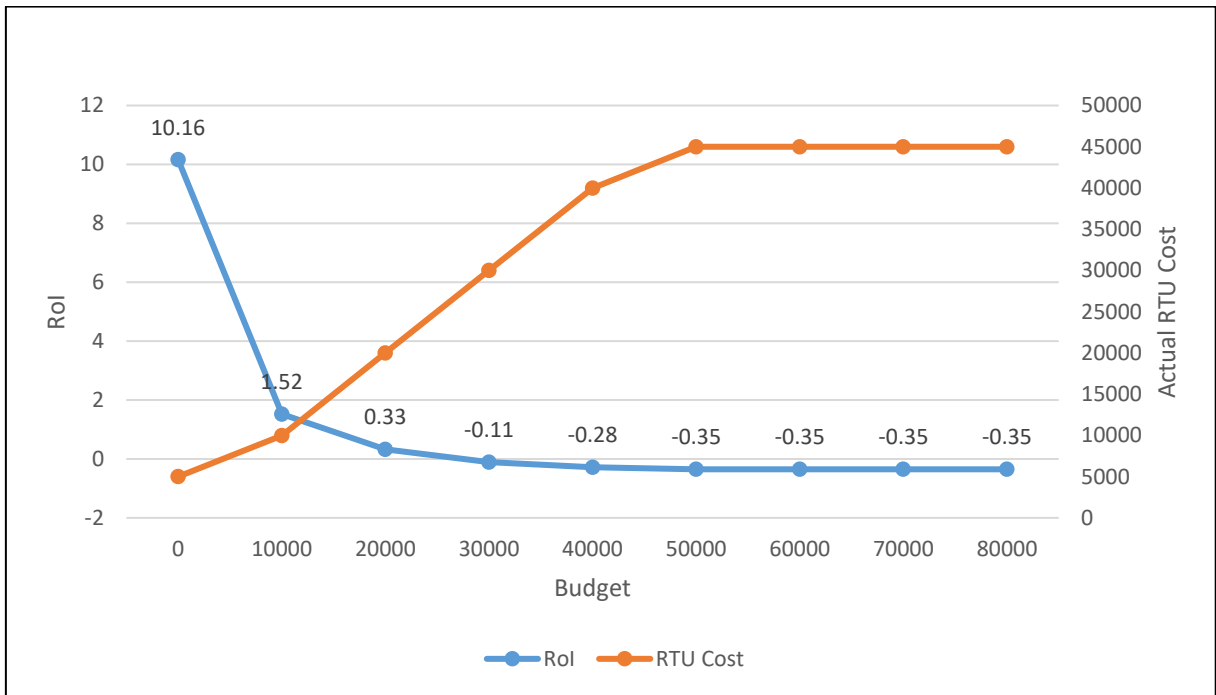

Figure 5-17. Two-feeders - RoI vs RTU Cost for all automated substations

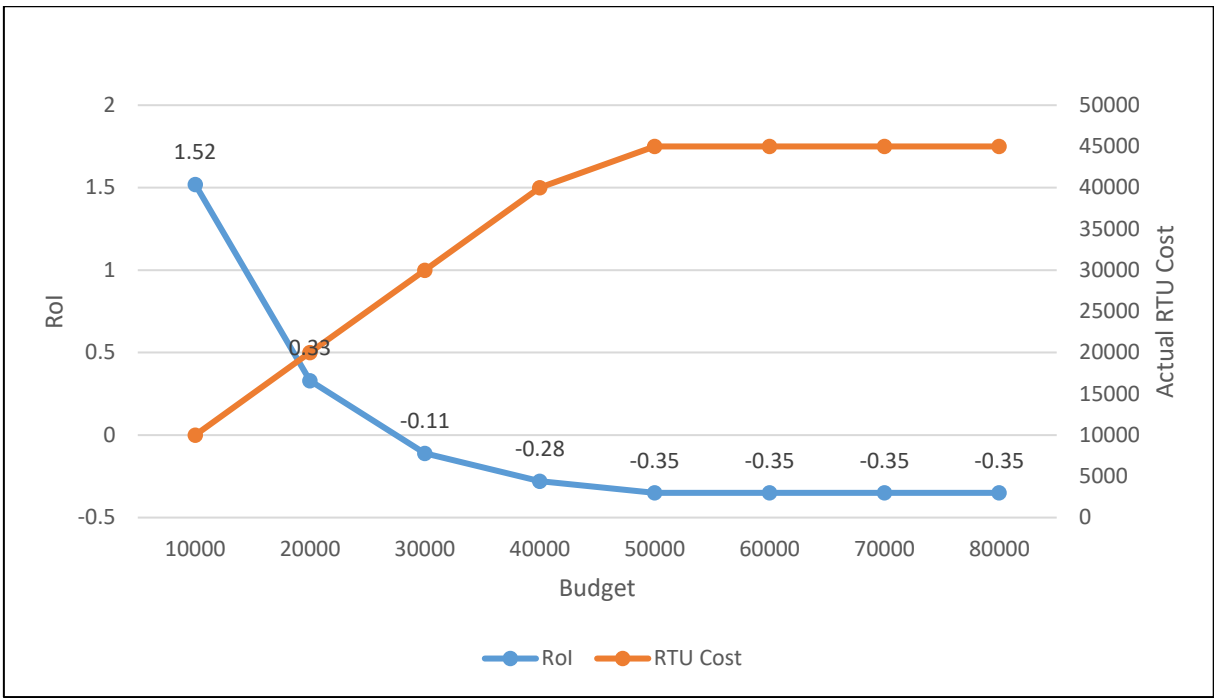

Figure 5-18. Tow-feeders - RoI vs RTU Cost considering budget only, excluding already automated substations

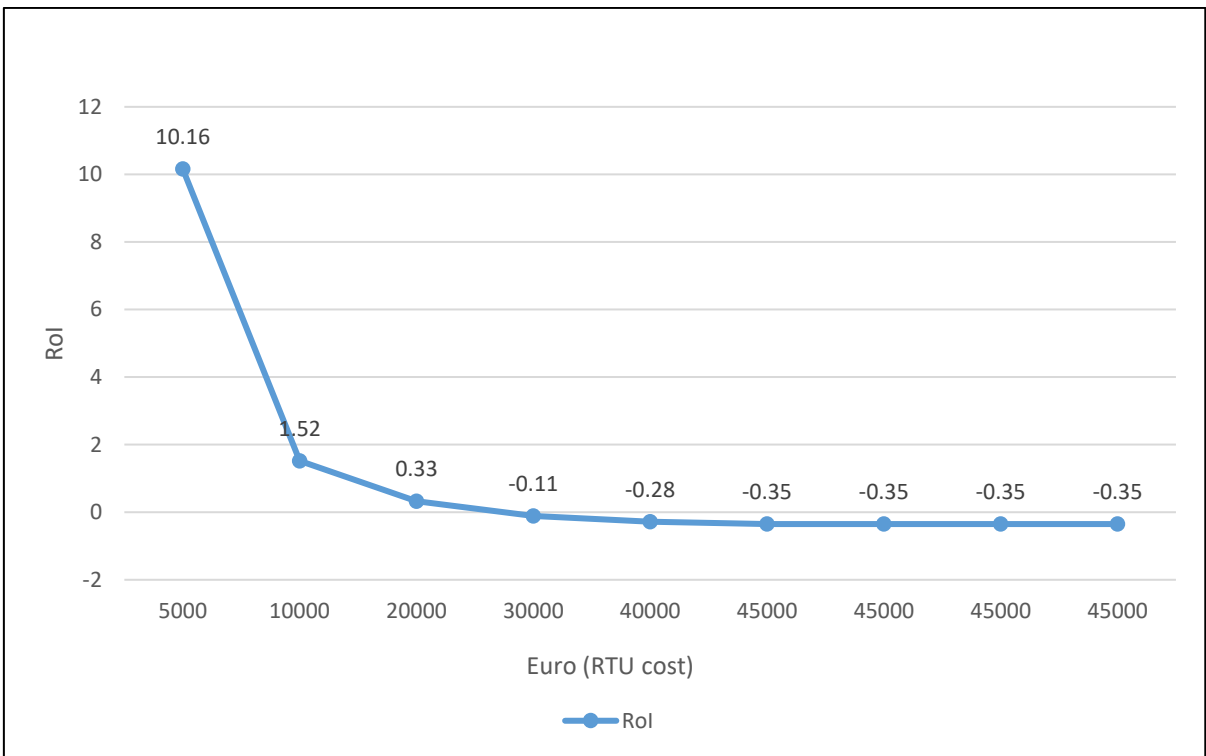

Figure 5-19. Return of Investment against the cost of RTUs

### 5.7.3 Four-feeder network

The optimisation for the Return of Investment was applied to a four-feeder network. The results are given in Table 5-21 and Table 5-22. RoI results for four-feeder network – recommended substations. The graph in Figure 5-20 includes the substations with an automated NOP. Graph in Figure 5-21 excluded the NOP substations and looks at the proposed substations. The optimum point is reached when €40,000 are invested in RTU to automate nine substations.

The four-feeder network shows that automating about 45% of the substations, that is nine substations from twenty substations, the return of investment is almost 100%.

Table 5-21. RoI results for four-feeder network

<b>Automated substations</b>	<b>Budget Increment (Euro)</b>	<b>RoI (Euro)</b>	<b>Actual Cost (Euro)</b>
No substations automated	0	61,834.70	0
Already automated substations	0	61,834.70	0
Normally Open Points to automate	0	3.64	13,000
1	10,000	1.32	10,000
2	20,000	0.52	20,000
3	30,000	0.13	30,000
4	40,000	-0.1	40,000
5	50,000	-0.24	50,000
6	60,000	-0.33	59,000
7	70,000	-0.4	69,000
8	80,000	-0.44	77,000
9	90,000	-0.44	77,000
10	100,000	-0.44	77,000
11	110,000	-0.44	77,000
12	120,000	-0.44	77,000
13	130,000	-0.44	77,000
14	140,000	-0.44	77,000
15	150,000	-0.44	77,000
16	160,000	-0.44	77,000

Table 5-22. Rol results for four-feeder network – recommended substations

Automated substations	Substations to automate (Node Number)																
No substations automated	Nil																
Already automated substations	Nil																
Normally Open Points to automate	5, 10, 15																
1	3	7															
2	4	8	13	18	20												
3	2	4	8	9	12	17	20										
4	3	4	6	8	11	13	17	19	20								
5	2	3	4	6	7	8	11	12	16	19	20						
6	2	3	4	6	7	8	9	11	12	13	17	18	19	20			
7	1	2	3	4	6	7	8	9	11	12	13	17	18	19	20		
8	1	2	3	4	6	7	8	9	11	12	13	14	16	17	18	19	20
9	1	2	3	4	6	7	8	9	11	12	13	14	16	17	18	19	20
10	1	2	3	4	6	7	8	9	11	12	13	14	16	17	18	19	20
11	1	2	3	4	6	7	8	9	11	12	13	14	16	17	18	19	20
12	1	2	3	4	6	7	8	9	11	12	13	14	16	17	18	19	20
13	1	2	3	4	6	7	8	9	11	12	13	14	16	17	18	19	20
14	1	2	3	4	6	7	8	9	11	12	13	14	16	17	18	19	20
15	1	2	3	4	6	7	8	9	11	12	13	14	16	17	18	19	20
16	1	2	3	4	6	7	8	9	11	12	13	14	16	17	18	19	20

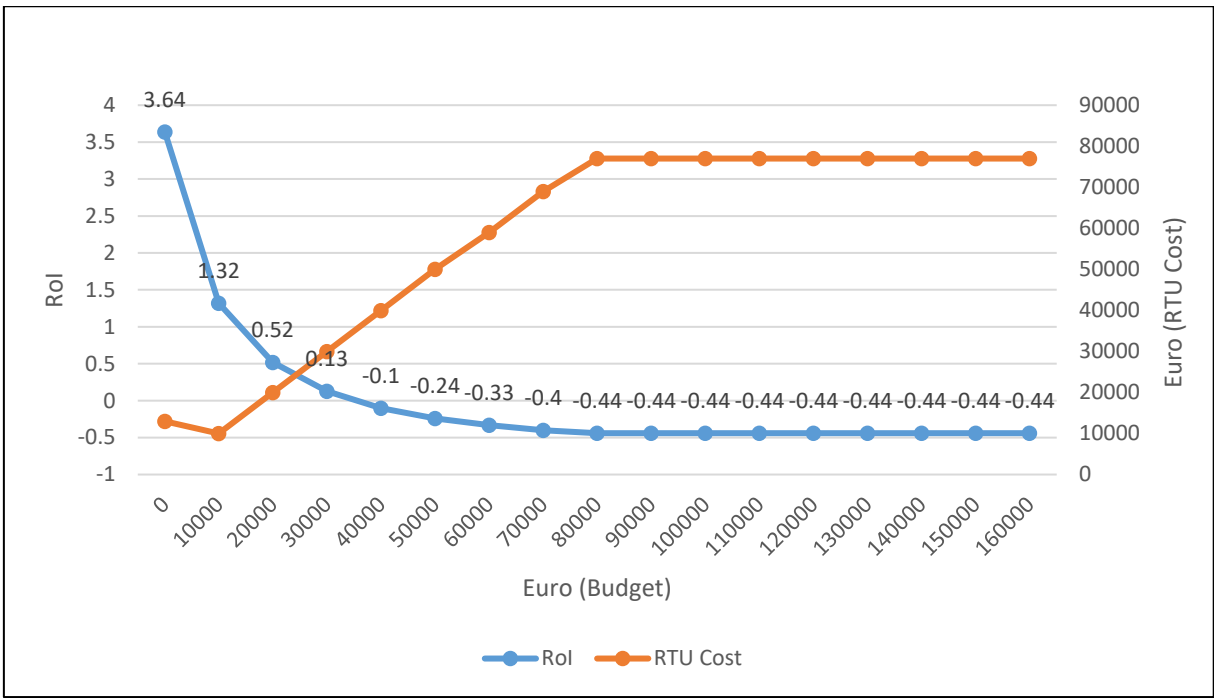

Figure 5-20. Four-feeders - Rol vs RTU Cost for all automated substations

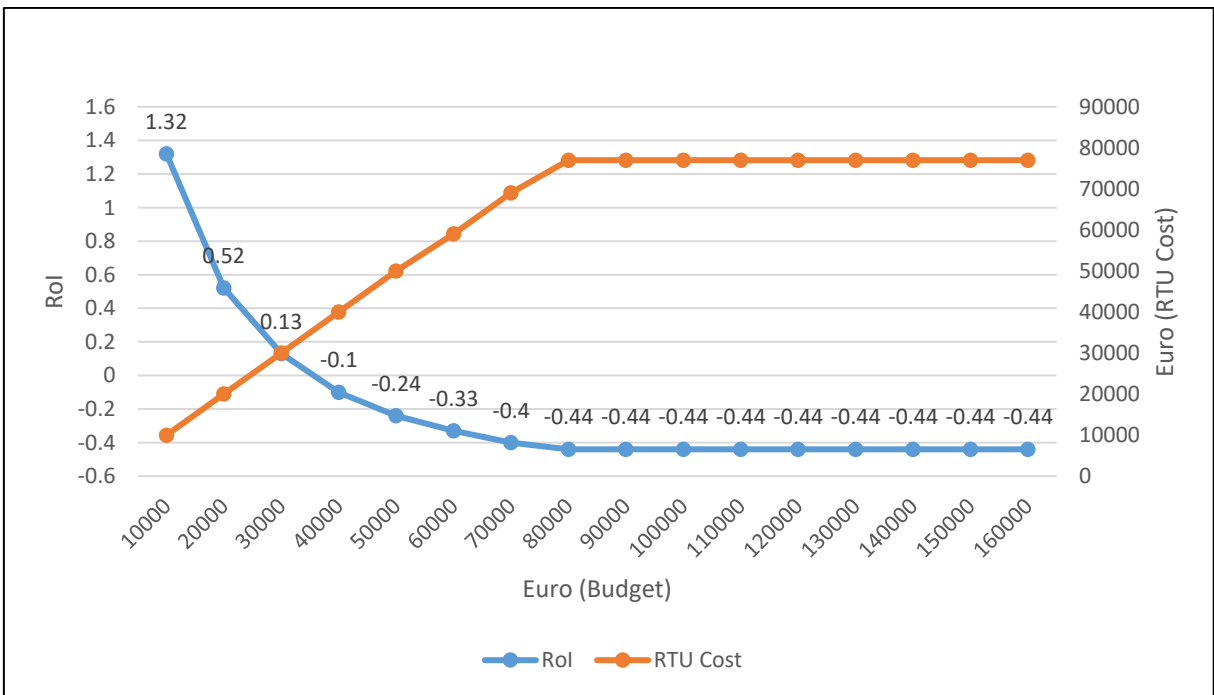

Figure 5-21. Four-feeders - Rol vs RTU Cost considering budget only, excluding already automated substations

## 5.8 Substations which have been previously automated

In the previous sections, substations that are already automated were not taken into consideration. Using the same method in this study, substations that are already automated can be included and the GA will take into consideration these and optimise the locations based on the presented network.

To analyse the method, several substations are set to have automation. For example, it is assumed that one substation is automated in the middle of each feeder. The restrictions for the substations are kept the same as in previous analyses. The analysis is done using the transformer peak load.

Looking at Figure 5-22, using the assumption mentioned, SS4 is already automated because it is in the middle of the feeder, hence the analysis could be done. For the two-, three- and four-feeder networks, some substations are assumed to be automated.

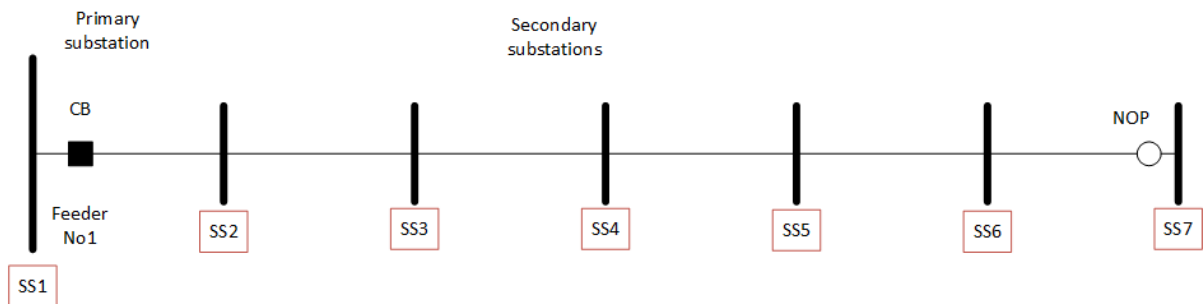

Figure 5-22. MV feeder with SS4 already automated



### 5.8.1 Two-feeder network

An analysis is done considering having some substations that were previously automated. For the two-feeder network it is being assumed that two substations have been automated, namely SS3 and SS8.

The results are given in Table 5-23 and Table 5-24. Graphically the latter is given in Figure 5-23.

Table 5-23. Results without substations already automated

Automated substations	Budget Increment (Euro)	Cost of Energy not supplied (Euro)	Actual Cost (Euro)	Substations to automate (Node Number)									
No substations automated	0	6,219.10	0	Nil									
Already automated substations	0	6,219.10	0	Nil									
Normally Open Points to automate	0	5,934.60	5,000	5									
1	10,000	4,486.35	9,000	3	10								
2	20,000	3,096.85	20,000	2	4	8	9	10					
3	30,000	2,680.75	30,000	2	4	6	7	8	9	10			
4	40,000	2,603.75	40,000	1	2	4	6	7	8	9	10		
5	50,000	2,531.75	45,000	1	2	3	4	6	7	8	9	10	
6	60,000	2,531.75	45,000	1	2	3	4	6	7	8	9	10	
7	70,000	2,531.75	45,000	1	2	3	4	6	7	8	9	10	
8	80,000	2,531.75	45,000	1	2	3	4	6	7	8	9	10	

Table 5-24. Results with substations already automated

Automated substations	Budget Increment (Euro)	Cost of Energy not supplied (Euro)	Actual Cost (Euro)	Substations to automate (Node Number)						
No substations automated	0	6,219.10	0	Nil						
Already automated substations	0	5,519.00	8,000	3, 8						
Normally Open Points to automate	0	4,672.00	13,000	5						
1	10,000	3,466.85	15,000	2	9	10				
2	20,000	2,783.35	19,000	2	4	6	10			
3	30,000	2,608.75	27,000	2	4	6	7	9	10	
4	40,000	2,531.75	37,000	1	2	4	6	7	9	10
5	50,000	2,531.75	37,000	1	2	4	6	7	9	10
6	60,000	2,531.75	37,000	1	2	4	6	7	9	10

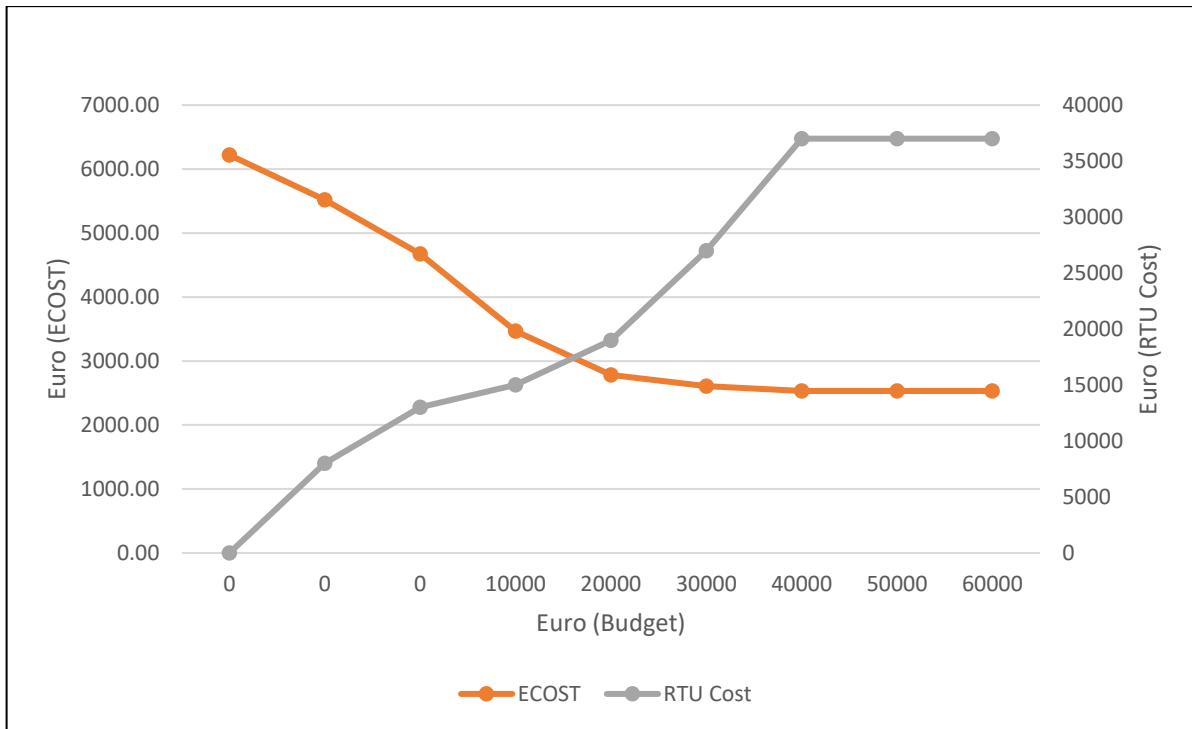

Figure 5-23. Two-feeders - ECOST considering transformer peak load (kW) with two substations already automated.

## 5.8.2 Four-feeder network

The four-feeder network was analysed, first considering that no substations have been automated except the normally open points and then having four substations automated in addition to the normally open points.

The four substations that are considered as having been already automated are: SS3, SS8, SS13 and SS18.

The results without previous automated substations are given in Table 5-25 and Table 5-26.

Table 5-27 and Table 5-28 show the results when considering that four substations have been automated before the analysis was carried out.

Table 5-25. Results without substations already automated

<b>Automated substations</b>	<b>Budget Increment (Euro)</b>	<b>Cost of Energy not supplied (Euro)</b>	<b>Actual Cost (Euro)</b>
No substations automated	0	11,931.55	0
Already automated substations	0	11,931.55	0
Normally Open Points to automate	0	10,770.90	13,000
1	10,000	8,395.30	9,000
2	20,000	7,183.75	19,000
3	30,000	6,396.40	30,000
4	40,000	5,798.25	38,000
5	50,000	5,655.95	49,000
6	60,000	5,407.55	59,000
7	70,000	5,299.25	67,000
8	80,000	5,222.25	77,000
9	90,000	5,222.25	77,000
10	100,000	5,222.25	77,000
11	110,000	5,222.25	77,000
12	120,000	5,222.25	77,000
13	130,000	5,222.25	77,000
14	140,000	5,222.25	77,000
15	150,000	5,222.25	77,000
16	160,000	5,222.25	77,000

Table 5-26. Results without substations already automated - locations

Automated substations	Substations to automate (Node Number)																
No substations automated	Nil																
Already automated substations	Nil																
Normally Open Points to automate	5, 10, 15																
1	2	8	13														
2	2	8	13	18	19	20											
3	2	4	7	12	13	19	20										
4	2	4	6	8	12	13	17	19	20								
5	2	4	7	8	9	11	12	13	17	18	19	20					
6	2	3	4	6	7	8	9	11	12	13	17	18	19	20			
7	2	3	4	6	7	8	9	11	12	13	14	16	17	18	19	20	
8	1	2	3	4	6	7	8	9	11	12	13	14	16	17	18	19	20
9	1	2	3	4	6	7	8	9	11	12	13	14	16	17	18	19	20
10	1	2	3	4	6	7	8	9	11	12	13	14	16	17	18	19	20
11	1	2	3	4	6	7	8	9	11	12	13	14	16	17	18	19	20
12	1	2	3	4	6	7	8	9	11	12	13	14	16	17	18	19	20
13	1	2	3	4	6	7	8	9	11	12	13	14	16	17	18	19	20
14	1	2	3	4	6	7	8	9	11	12	13	14	16	17	18	19	20
15	1	2	3	4	6	7	8	9	11	12	13	14	16	17	18	19	20
16	1	2	3	4	6	7	8	9	11	12	13	14	16	17	18	19	20

Table 5-27. Results with substations already automated

<b>Automated substations</b>	<b>Budget Increment (Euro)</b>	<b>Cost of Energy not supplied (Euro)</b>	<b>Actual Cost (Euro)</b>
No substations automated	0	11,931.55	0
Already automated substations	0	10,532.30	14,000
Normally Open Points to automate	0	8,226.75	27,000
1	10,000	6,931.25	10,000
2	20,000	6,376.45	20,000
3	30,000	5,781.45	30,000
4	40,000	5,505.65	40,000
5	50,000	5,340.85	50,000
6	60,000	5,263.85	60,000
7	70,000	5,222.25	63,000
8	80,000	5,222.25	63,000
9	90,000	5,222.25	63,000
10	100,000	5,222.25	63,000
11	110,000	5,222.25	63,000
12	120,000	5,222.25	63,000

Table 5-28. Results with substations already automated - locations

Automated substations	Substations to automate (Node Number)												
No substations automated	Nil												
Already automated substations	3, 8, 13, 18												
Normally Open Points to automate	5, 10, 15												
1	2	19	20										
2	2	7	12	19	20								
3	2	4	6	9	12	19	20						
4	2	4	6	7	9	12	17	19	20				
5	2	4	6	7	9	11	12	16	17	19	20		
6	1	2	4	6	7	9	11	12	16	17	19	20	
7	1	2	4	6	7	9	11	12	14	16	17	19	20
8	1	2	4	6	7	9	11	12	14	16	17	19	20
9	1	2	4	6	7	9	11	12	14	16	17	19	20
10	1	2	4	6	7	9	11	12	14	16	17	19	20
11	1	2	4	6	7	9	11	12	14	16	17	19	20

## 5.9 Summary

The previous chapters presented new concepts and optimisation methods developed to link the site operational experiences to an academic study. The concepts presented in Chapter 3 were further developed to an optimisation method in Chapter 4 with the latter chapter focusing on the optimisation of the customer minutes lost on which substation locations were selected.

The cost related to the energy not supplied was not considered in Chapter 4, but the optimisation method was further developed in this chapter to consider the cost concept.

Cost consideration for energy lost based on transformer rating or transformer peak load was taken when analysing the three types of network models. A cost value was given to the duration to restore supply. This was obtained by considering the labour cost of engineers and the duration to perform switching operations in the process to restore supply to all customers. The duration time included any restriction time that may arise for substation access, substation location and switchgear operational restrictions.

A new reliability index is presented, FAIDI. This is like the CAIDI index, but presents a better way of expressing the feeder performance.

Summarising the analysis done using the proposed optimisation method, the following must be highlighted:

1. Improving FAIDI by 72% with 65% of the substations automated
2. Considering the transformer rating in kVA, 55% reduction in lost energy cost was realised for the optimum point when 60% of the substations are automated
3. If the transformer peak power, in kW, is considered, the optimum point indicates that a reduction of 50% is achieved for the lost energy cost with 55% of the substations automated
4. The Return of Investment for 15 years was considered. This showed that automating 50% of the substations, the return of investment is 99%, a point where the investment done is feasible

This chapter also proved that the optimisation method, presented in this research, is equipped and capable of analysing those distribution networks that already have some substations automated.

The optimisation methodologies presented in Chapters 4 and 5 will be used for a case study in Chapter 6. A real distribution network will be modelled, and the optimisation methods will be applied.



## Chapter 6 - Case study for the Maltese Islands MV network

The optimisation methodology developed in Chapters 4 and 5 and used to analyse three types of network models, was applied to a real 11kV network managed by the DSO in Malta. Part of the Maltese 11kV network was modelled using Matlab. The optimisation method results obtained for the case study are compared to results that would have been achieved if the substations automated by the DSO were taken into consideration. The DSO in Malta had selected and equipped substations with automation based on the DSO engineers' experience.

The Maltese archipelago consists of three main islands namely Malta, Comino, and Gozo. Malta and Gozo are the two islands with inhabitants, while Comino has only two inhabitants but is more active with locals and tourists during the summer months. Gozo is northwest of Malta, as shown in Figure 6-1.

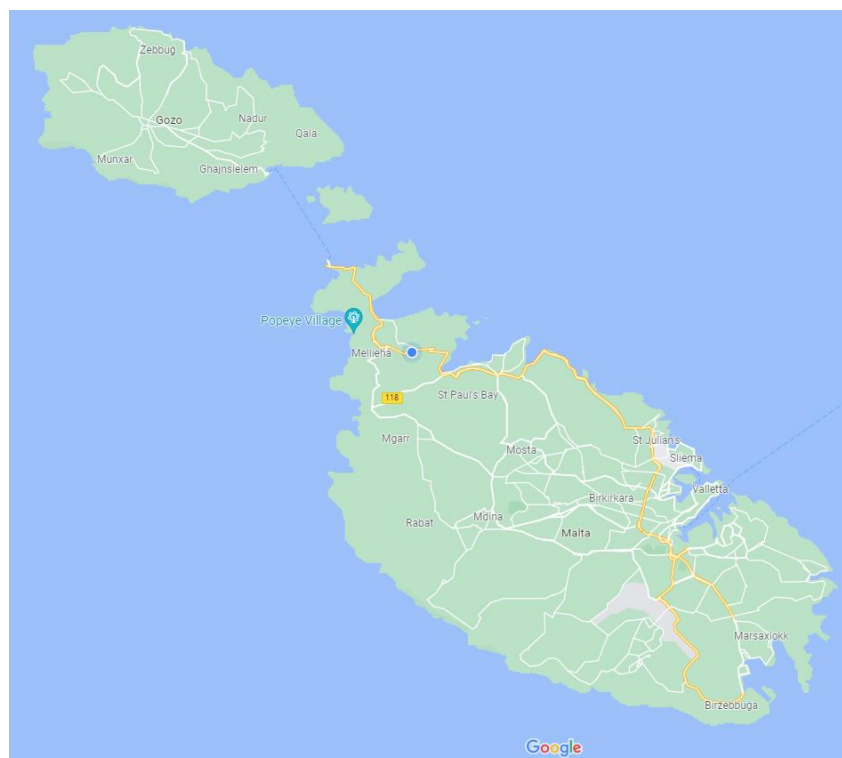

Figure 6-1. The Maltese Islands

The Maltese power systems voltages are 220kV, 132kV, 33kV, 11kV and 400V. One power station is located at the southwest of Malta and a 220kV AC interconnector connects the Maltese islands to Sicily and the European grid. The 11kV MV network consists of 1,400 substations located around the three main islands. Gozo is fed by three 33kV submarine cables connected to two primary 33/11kV substations. These two substations supply the 11kV MV network in Gozo. On average, forty 11/0.4kV substations are commissioned each year either in Malta and Gozo. These supply new loads or are additional substations to reinforce the LV network. LV network reinforcement could arise from network voltage drop or existing substations reaching their maximum capacity.

## 6.1 Gozo 11kV network

The 11kV network in Gozo consists of two 33/11kV primary substations and 144 11/0.4kV substations. These substations interconnect between the two primary substations. This network was included in the substation automation project and by end 2020, 41 substations have been equipped with automation.

In Chapter 4 and 5, the proposed methodology was applied to three types of networks having, two, three and four feeders with 21 substations as the maximum number considered.

The same methodology was applied to Gozo network having six feeders and eight feeders from Qala and Xewkija primary substations respectively as shown in Figure 6-2.

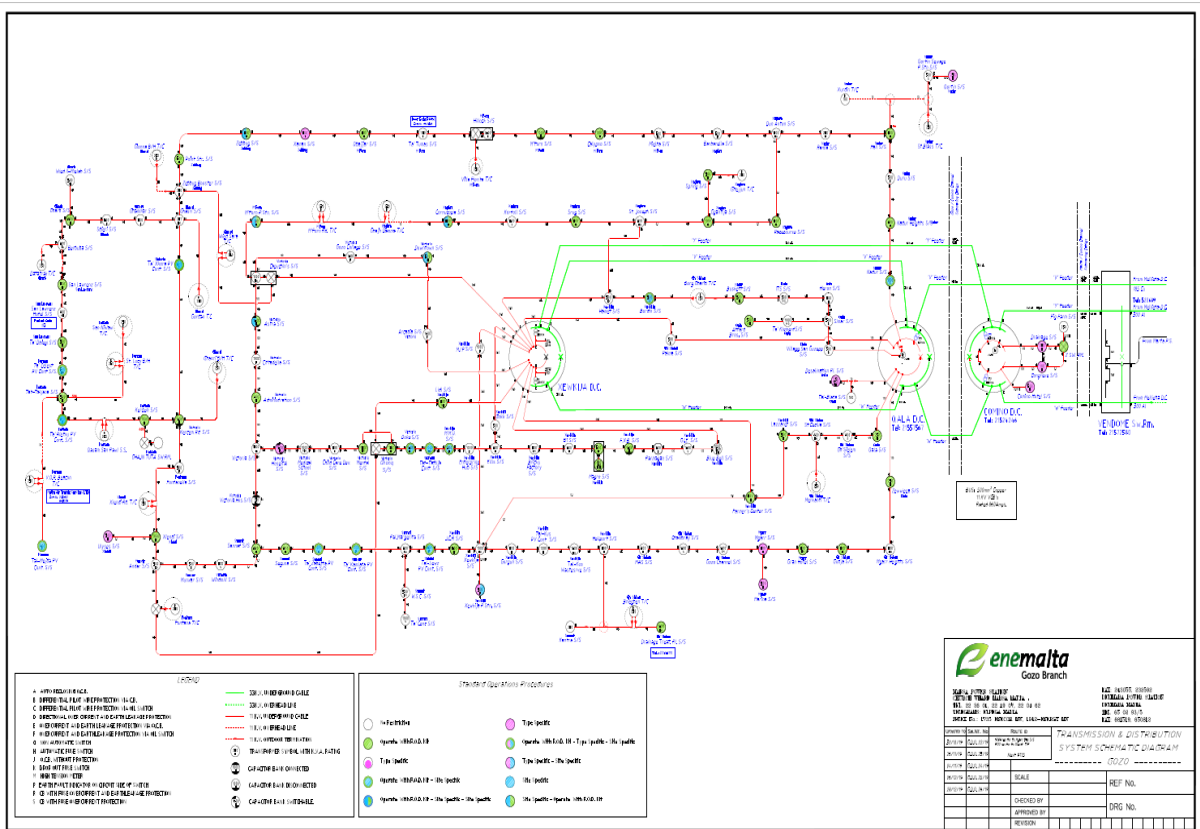

Figure 6-2. Gozo MV network. Courtesy of Enemalta plc®

The data from the optimisation algorithm is provided in Table 6-1. This data shows the set budget for analysis and the estimated cost per substation. The Gozo network consists of fourteen feeders and these are interconnected through sixteen substations having a normally open point.

Table 6-1. Algorithm data

Information	Qty
Budget	€200,000
Estimated cost per substation	€10,000
Substations	144
Source Buses	1
Feeders	14
Automated substations	0
Substations with NOP	16

Since the Matlab model does not consider the 33kV network loading, that may be caused from any network changes downstream, the primary nodes have been combined into one node. However, all 11kV feeders have been kept separated. The Gozo MV network data, under normal operation configuration, was modelled in Matlab.

The same analysis conducted for the typical networks was applied to the Gozo network. The model will run assuming that no substations have been automated, with all NOP automated and the use the Genetic Algorithm to suggest the optimum additional substations, apart from the NOPs, for automation.

Another analysis was done considering the existing automated substations and then compare the results with those obtained form the proposed method.

Given that the distribution network being modelled in Matlab have spurs and several interconnections, it was possible that the actual results may not follow a steady smooth curve in improvement as has been achieved in the models for two, three and four feeders. The initial results in fact showed such possible results. To ensure that optimum results are obtained for this larger network, the GA was run at least ten (10) times, this against the three to five times for the smaller networks. A polynomial equation is used for the results obtained and its curve gave a better visualisation of the graph. The point where the polynomial curve intersects the budget curve is taken as the indicative optimum point. From this point onwards the polynomial curve rate of decay will be much less and proceeds horizontally, meaning that improvement has saturated.

The results obtained will be presented hereunder and the outcome discussed.

## 6.2 Customer Minutes Lost (CML)

The optimisation algorithm for CML was applied to the Gozo network. A budget of €200,000 was applied. The first analysis was done considering that all substations did not have any restrictions and then another analysis was conducted considering the actual restrictions of the network.

### 6.2.1 Substations without any restrictions

The results obtained for the Customer Minutes Lost, setting all substations without any restrictions are graphically shown in Figure 6-3. The trend line for the actual results follows the expected decay. This intercepts the budget increase graph at a budget value of €120,000. Considering the fixed cost per substation, 12 substations can be automated at this point. However, considering the actual cost, which resulted in €117,500, 37 substations could be automated. The actual cost is within the budget allocated of €120,000. Refer to Table 6-2 for the results obtained.

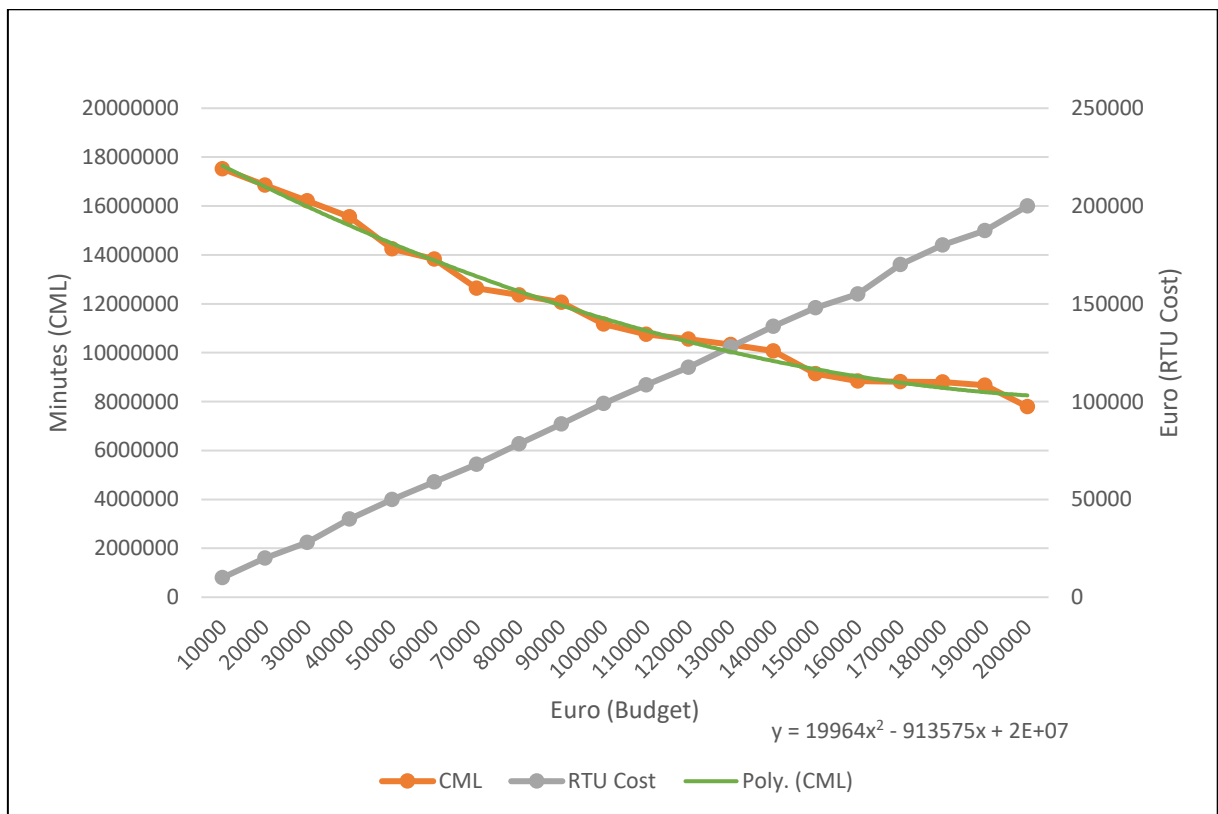

Figure 6-3. Gozo CML results without restrictions

Table 6-2. Quantity of substations that can be automated

<b>Automated substations</b>	<b>Budget Increment (Euro)</b>	<b>Customer Minutes Lost (min)</b>	<b>Actual Cost (Euro)</b>	<b>Substations to automate (Qty)</b>
No substations automated	0	26,372,820	0	Nil
Already automated substations	0	26,372,820	0	Nil
Normally Open Points to automate	0	19,651,890	60,000	16
1	10,000	17,523,390	10,000	5
2	20,000	16,851,540	20,000	8
3	30,000	16,208,625	28,000	11
4	40,000	15,560,715	40,000	14
5	50,000	14,243,700	50,000	18
6	60,000	13,832,420	59,000	21
7	70,000	12,643,820	68,000	23
8	80,000	12,359,055	78,500	27
9	90,000	12,057,635	88,500	28
10	100,000	11,172,525	99,000	32
11	110,000	10,757,235	108,500	33
12	120,000	10,557,235	117,500	37
13	130,000	10,339,075	128,000	38
14	140,000	10,066,285	138,500	44
15	150,000	9,147,225	148,000	45
16	160,000	8,834,775	155,000	47
17	170,000	8,820,015	170,000	48
18	180,000	8,796,900	180,000	51
19	190,000	8,673,915	187,500	56
20	200,000	7,790,880	200,000	53

## 6.2.2 Substations with actual restrictions

Gozo MV network was analysed again, now including the actual substations restrictions.

The results obtained are shown graphically in Figure 6-4. The trend line intercepts the budget line at €120,000. Like the CML results without any restrictions, 12 substations can be automated if a fixed cost is assumed else 37 substations can be automated using the actual cost per selected substation.

The quantity of selected substations against the budget increment are given in Table 6-3.

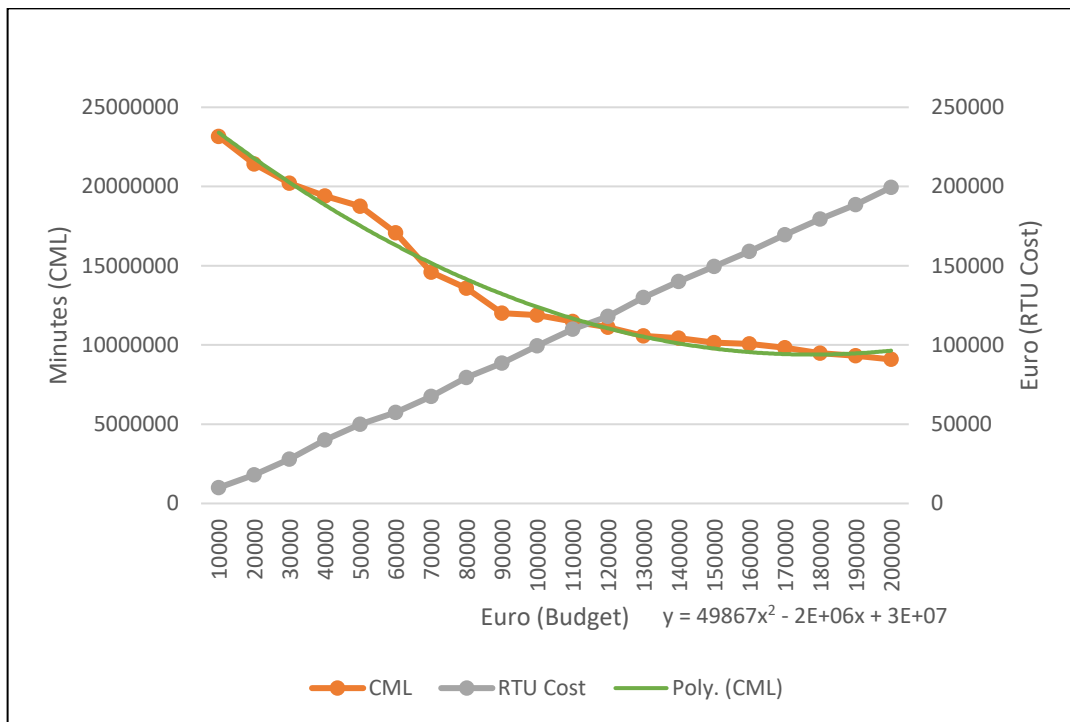

Figure 6-4. Gozo CML results with restrictions

Table 6-3. Quantity of substations with restrictions that can be automated

<b>Automated substations</b>	<b>Budget Increment (Euro)</b>	<b>Customer Minutes Lost (min)</b>	<b>Actual Cost (Euro)</b>	<b>Substations to automate (Qty)</b>
No substations automated	0	37,734,095	0	Nil
Already automated substations	0	37,734,095	0	Nil
Normally Open Points to automate	0	26,740,545	60,000	16
1	10,000	23,151,270	10,000	5
2	20,000	21,414,635	18,000	7
3	30,000	20,208,485	28,000	11
4	40,000	19,392,920	40,000	15
5	50,000	18,765,075	50,000	17
6	60,000	17,086,770	57,500	20
7	70,000	14,584,805	67,500	24
8	80,000	13,589,275	79,500	27
9	90,000	12,009,715	88,500	31
10	100,000	11,889,385	99,500	31
11	110,000	11,478,415	110,000	37
12	120,000	11,119,280	118,000	37
13	130,000	10,582,420	130,000	41
14	140,000	10,439,795	140,000	40
15	150,000	10,156,795	149,500	44
16	160,000	10,071,365	159,000	49
17	170,000	9,818,520	169,500	43
18	180,000	9,478,505	179,500	49
19	190,000	9,328,820	188,500	44
20	200,000	9,089,655	199,500	50



The two results obtained when considering the network having some substation with restrictions and then assuming that all substations do not have any restrictions, are given in Table 6-4. Comparing both results, although the quantity of selected substations is the same, several locations of substations have changed. This reflects the additional time required for any restriction that a substation may have. Therefore, when considering the restriction time, which will result in longer restoration time, the proposed method will find the optimum locations to ensure that the restoration time is kept to the minimum possible.

Table 6-4. Comparing the selected substations without restrictions against those with restrictions

Qty	Substations to be automated considering restrictions	Substations to be automated but not considering restrictions	Qty	Substations to be automated considering restrictions	Substations to be automated but not considering restrictions
1	2	2	20	80	80
2	4	6	21	89	81
3	11	10	22	94	84
4	18	11	23	95	89
5	21	18	24	99	94
6	23	22	25	104	99
7	24	23	26	108	102
8	25	26	27	114	104
9	31	33	28	117	108
10	32	36	29	120	110
11	38	38	30	123	120
12	48	45	31	129	123
13	58	47	32	133	128
14	64	48	33	136	129
15	67	62	34	137	134
16	68	63	35	138	135
17	69	66	36	139	138
18	73	67	37	142	140
19	75	68			

### 6.3 FAIDI for Gozo network

The Gozo 11kV network has fourteen feeders fed from two primary substations located in Qala and Xewkija. The optimisation algorithm for FAIDI was used to obtain the feeder average interruption duration. The graph curve from the results obtained follow the same curves obtained for the two, three and four feeders that were evaluated in Chapter 6.

Figure 6-5 show the FAIDI curve, in minutes, for the network in Gozo. A polynomial curve for the results obtained is shown and this is used to find the optimum point. The optimum point suggests that at an actual RTU cost of €128,000, which is within the €130k budget.

Translating the FAIDI curve to a scatter type chart and obtaining the trendline using a 2<sup>nd</sup> order polynomial curve will give the polynomial formula as follows:

$$y = 9 \times 10^{-9}x^2 - 0.0036x + 650.52 \quad (50)$$

Using the budget cost of €130,000 in the formula, then FAIDI will be

$$FAIDI = (9 \times 10^{-9} \times 130000^2) - (0.0036 \times 130000) + 650.52 = 334.62 \text{ min}$$

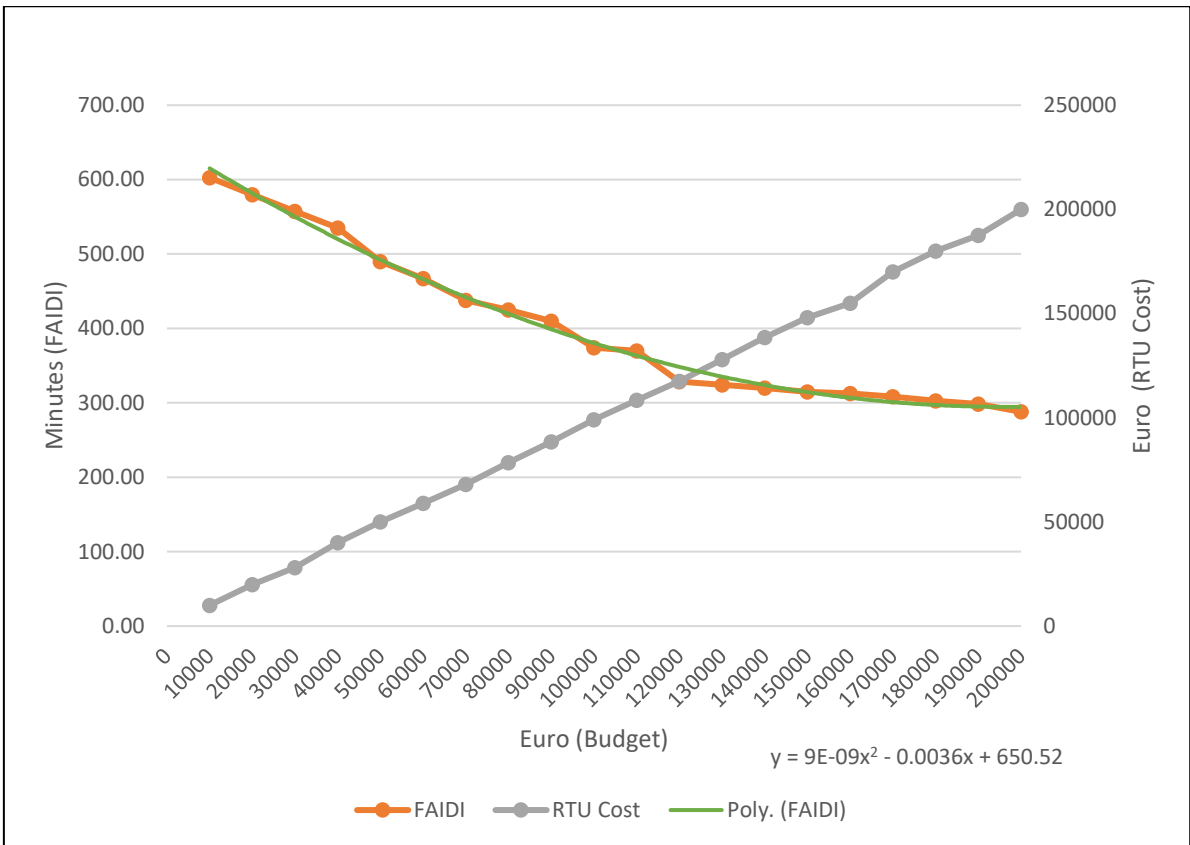

Figure 6-5. FAIDI in minutes

A budget of €2 million, to cover the cost of all 144 substations in Gozo, was set. The graphical results obtained are shown in Figure 6-6.

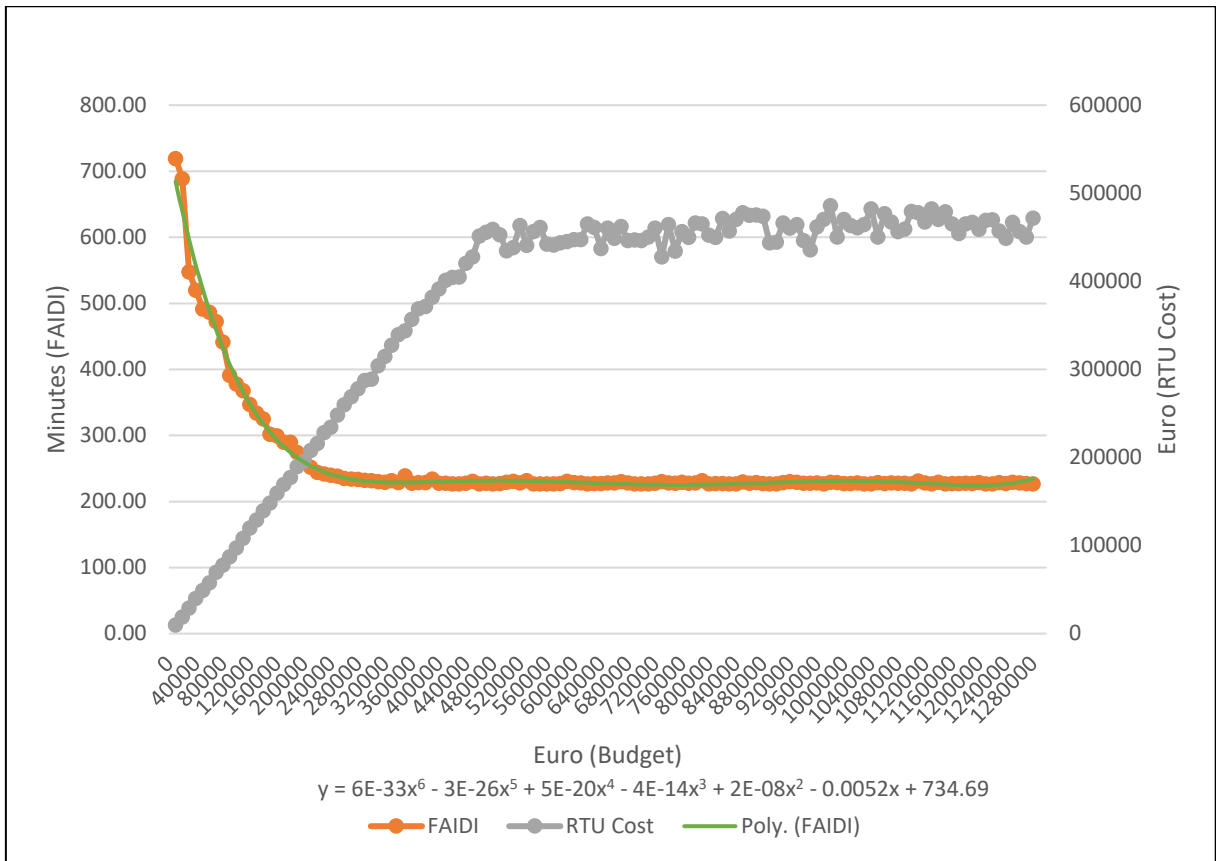

Figure 6-6. FAIDI in minutes with full budget

As can be seen the FAIDI graph reaches a saturation point which is around the a €200,000 budget. This means that if you invest in more substations beyond this point, the FAIDI improvement is minimal.

Table 6-5 shows the actual results and for a budget of €200,000, FAIDI is 266.34 minutes and 56 substations can be automated. The actual cost for the proposed substations will be €195,500.

Having a network consisting of 144 substations, this translates that if you automated around 38% of the substations, this should be enough for a decent FAIDI for the investment done.

Table 6-5. FAIDI in minutes for full budget

<b>Automated substations</b>	<b>Budget Increment (Euro)</b>	<b>FAIDI (min)</b>	<b>Actual Cost (Euro)</b>	<b>Substations to automate (Qty)</b>
No substations automated	0	907.06	0	Nil
Already automated substations	0	907.06	0	Nil
Normally Open Points to automate	0	764.72	55,000	16
1	10,000	719.48	10,000	5
2	20,000	688.72	19,000	8
3	30,000	547.64	29,000	11
4	40,000	520.02	40,000	15
5	50,000	491.42	49,000	18
6	60,000	486.69	58,000	21
7	70,000	472.83	70,000	25
8	80,000	441.43	78,000	27
9	90,000	391.30	87,500	30
10	100,000	378.14	97,500	33
11	110,000	367.88	108,500	33
12	120,000	347.06	120,000	37
13	130,000	333.94	129,000	38
14	140,000	325.43	139,500	43
15	150,000	302.23	148,500	44
16	160,000	299.58	159,500	47
17	170,000	290.06	169,500	47
18	180,000	289.81	177,500	49
19	190,000	274.60	190,000	49
20	200,000	266.34	195,500	56
21	210,000	252.16	208,000	57
22	220,000	244.41	216,000	58
23	230,000	242.05	228,500	59

## 6.4 Cost of Energy Not Supplied

The cost of energy not supplied during an interruption was obtained using the optimisation algorithm. The cost of energy was based on the transformer rating of each substation. The duration of interruption together with the transformers rating, in kVA, gave a value of power not supplied and this was quantified with the tariff rate per kVAh. This was done for substations without any restrictions and then repeated but having all substations set with the actual restrictions.

The results for both simulations are shown graphically in Figure 6-7 and Figure 6-8 respectively.

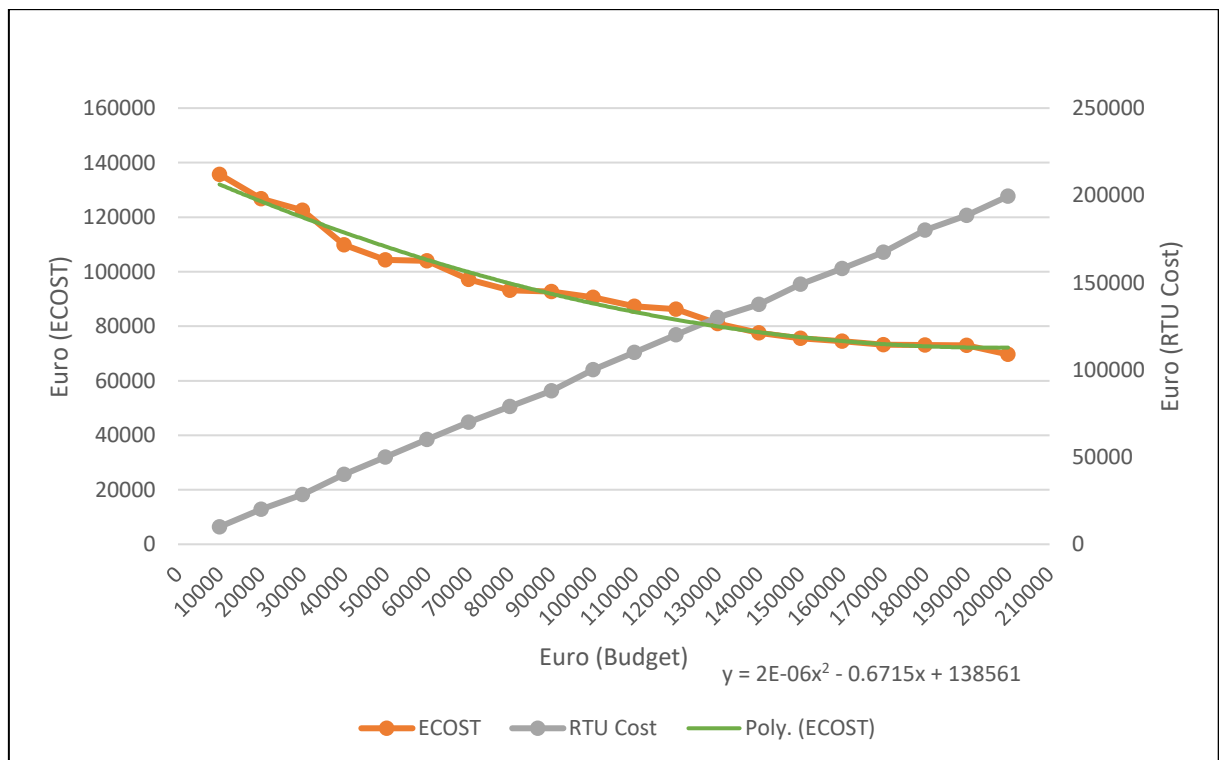

Figure 6-7. ECOST for transformer kVA rating and without restrictions

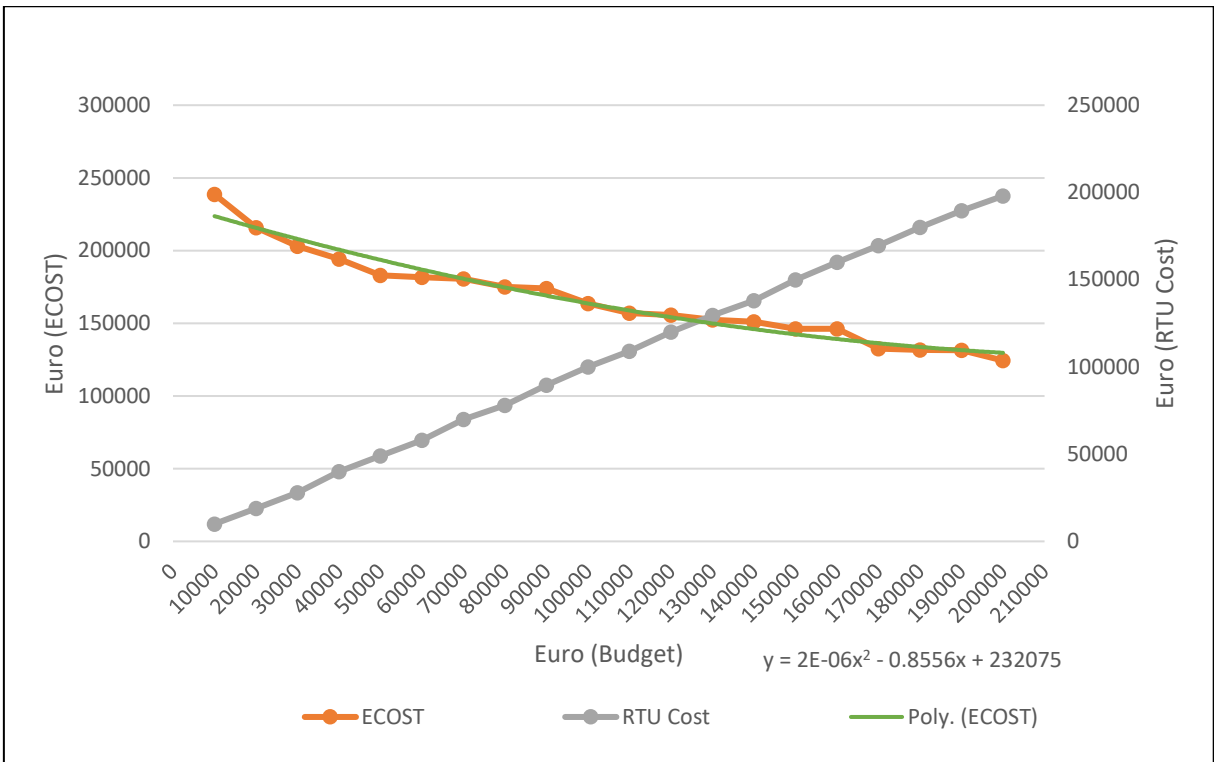

Figure 6-8. ECOST for transformer kVA rating and with restrictions

As discussed in Chapter 5, considering the transformer rating in kVA may not provide the correct cost for the energy not supplied, it was shown that using the actual power load of each transfer gives a better approximation for the cost of energy not supplied. Hence the peak power load for each transformer was considered.

The results, considering the peak power, are shown graphically in Figure 6-9 and Figure 6-10 respectively.



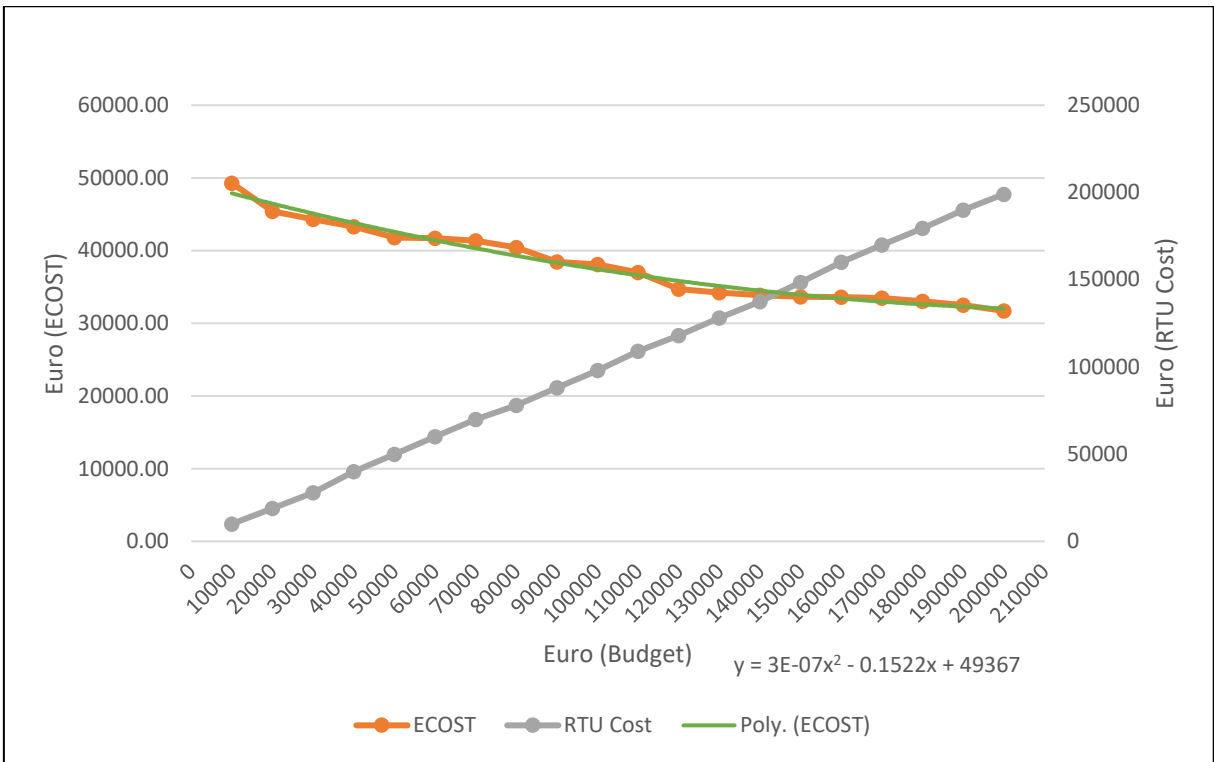

Figure 6-9. ECOST for transformer kWp rating and without restrictions

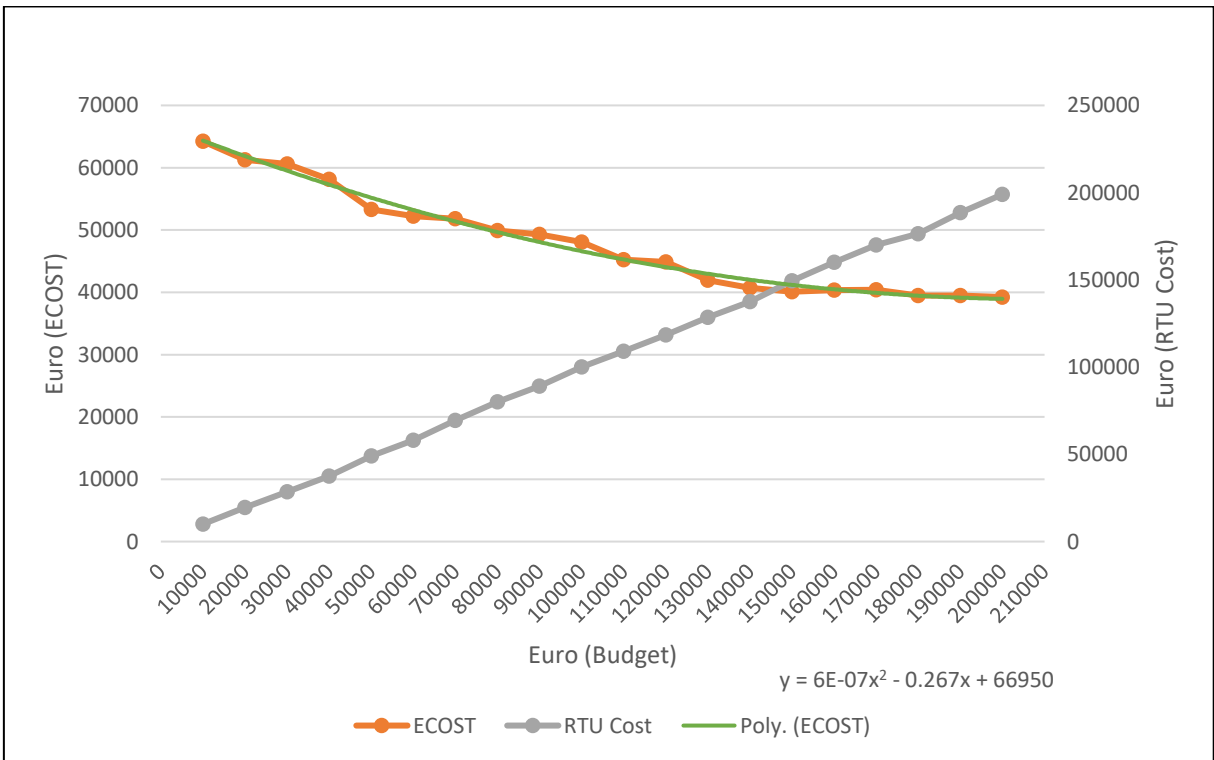

Figure 6-10. ECOST for transformer kWp rating and with restrictions

## 6.5 Value of Lost Load

The value of lost load method was applied to the MV in Gozo using a budget of €200,000. The results obtained are shown in Table 6-6. The results obtained, depending on the substation importance weighting, the energy lost and the duration that customers remain without supply. The results show that the VOLL for this MV network converge to a constant cost and remains so even though more substations are automated.

Table 6-6. VOLL with substation restrictions results

Automated substations	Budget Increment (Euro)	VOLL (Euro)	Actual Cost (Euro)	Substations to automate (Qty)
No substations automated	0	3.15881E+15	0	
Already automated substations	0	3.15881E+15	0	
Normally Open Points to automate	0	1.71233E+15	55,000	16
1	10,000	100,011,000	11,000	5
2	20,000	100,021,000	21,000	8
3	30,000	100,031,000	31,000	11
4	40,000	100,040,500	40,500	15
5	50,000	100,050,500	50,500	17
6	60,000	100,061,000	61,000	21
7	70,000	100,070,500	70,500	23
8	80,000	100,080,500	80,500	25
9	90,000	100,090,500	90,500	26
10	100,000	100,101,000	101,000	27
11	110,000	100,111,000	111,000	32
12	120,000	100,120,500	120,500	34
13	130,000	100,130,500	130,500	36
14	140,000	100,140,500	140,500	39
15	150,000	100,150,500	150,500	40
16	160,000	100,160,500	160,500	41
17	170,000	100,170,500	170,500	42
18	180,000	100,180,500	180,500	43
19	190,000	100,190,500	190,500	46
20	200,000	100,200,500	200,500	47

## 6.6 Automation and maintenance cost based on 15 years.

The cost of energy not supplied, considering the peak power of each transformer based over several years, was applied to the Gozo network. The duration was set at 15 years, given that this is a practical duration based on the general lifetime of RTUs and related equipment. The maintenance cost required during the 15 years duration was also included in the Algorithm simulation.

Figure 6-11 shows graphically the results obtained for the 15 years duration.

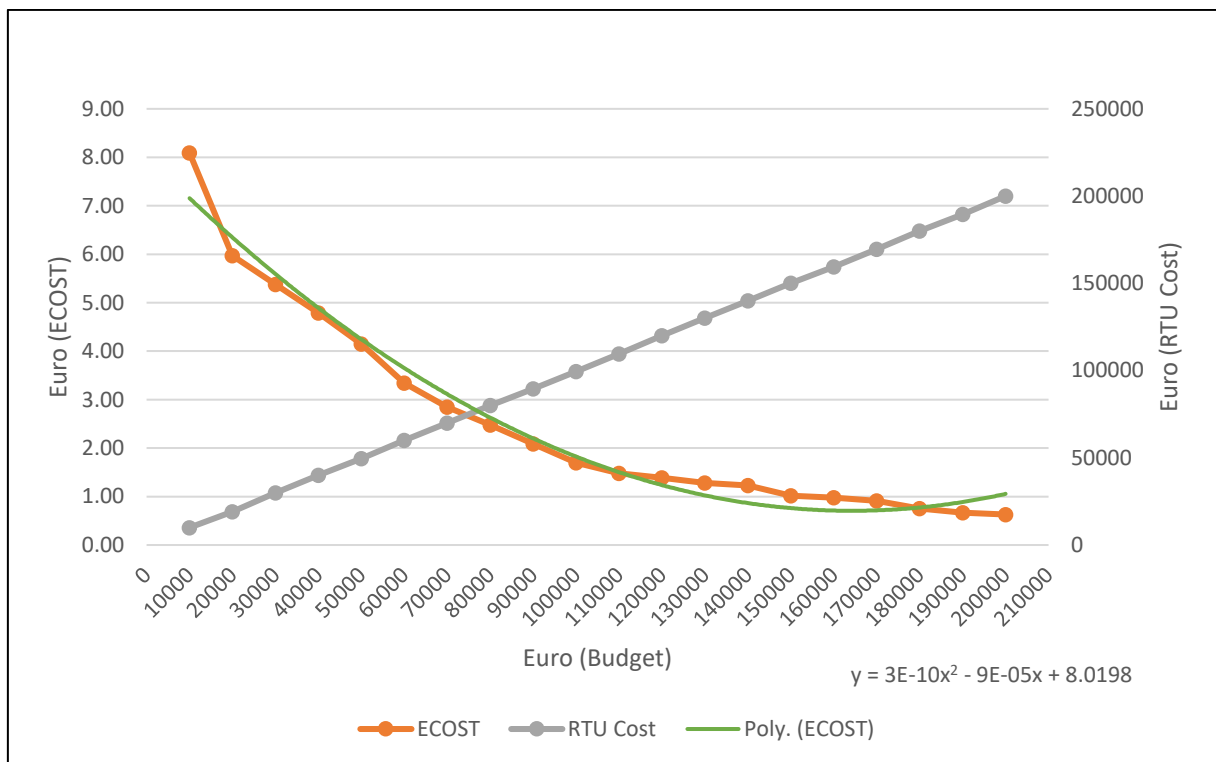

Figure 6-11. ECOST and maintenance cost for 15 years

The full budget of €2 million was applied to the same network and the graphical results are shown in Figure 6-12. As can be seen, the results reach a saturation point beyond the €400,000 budget.

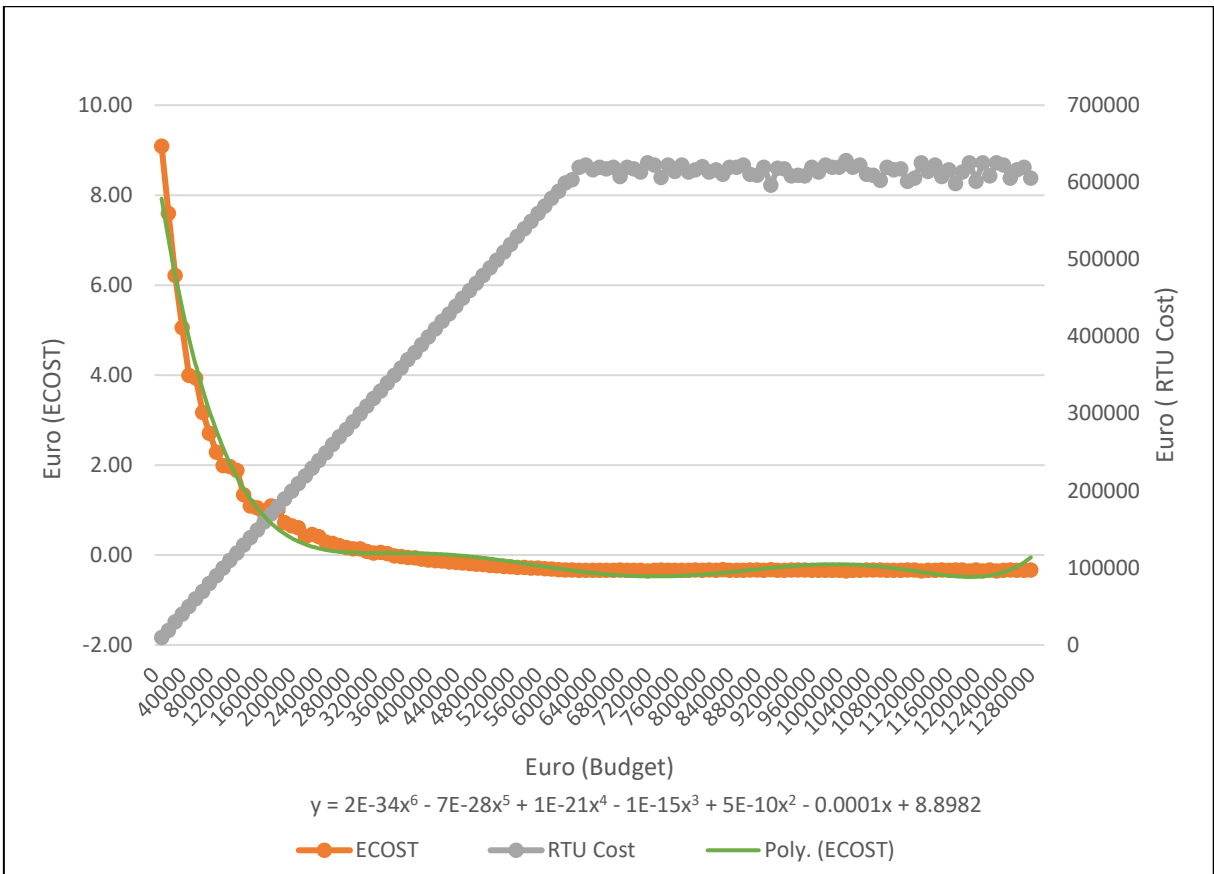

Figure 6-12. ECOST and maintenance cost for 15 years with full budget

Taking into consideration the budget optimum point of €200,000 the outcome is shown in Table 6-7. If each substation cost is assumed at €10,000, then twenty substations can be automated. However, when considering the actual cost, the algorithm identifies fifty-one (51) substations that can be automated. This means that around 35% of the substations in this network can be automated to achieve a reasonable practical result.

Table 6-7. ECOST for 15 years with full budget

Automated substations	Budget Increment (Euro)	ECOST for 15 years (Euro)	Actual Cost (Euro)	Substations to automate (Qty)
No substations automated	0	759,823.43	0	0
Already automated substations	0	759,823.43	0	0
Normally Open Points to automate	0	12.62	55,000	16
1	10,000	9.09	10,000	5
2	20,000	7.60	19,000	7
3	30,000	6.22	30,000	11
4	40,000	5.06	40,000	15
5	50,000	4.00	50,000	17
6	60,000	3.94	60,000	19
7	70,000	3.17	69,500	24
8	80,000	2.71	80,000	28
9	90,000	2.29	90,000	30
10	100,000	1.99	100,000	32
11	110,000	1.97	110,000	33
12	120,000	1.88	119,500	36
13	130,000	1.34	130,000	38
14	140,000	1.09	139,500	38
15	150,000	1.05	149,500	46
16	160,000	0.94	159,500	38
17	170,000	1.09	170,000	46
18	180,000	1.01	179,500	48
19	190,000	0.72	189,500	49
20	200,000	0.65	199,500	51
21	210,000	0.61	209,500	56
22	220,000	0.43	219,500	57
23	230,000	0.41	229,500	58

## 6.7 Considering already automated substations

When the DSO in Malta decided to proceed with automation of substations for the 11kV network, the 11kV network in Gozo was included in this project. It was estimated that about 10% of the substations are to be automated. The selection of location was based on network experience. Having visibility of some substations including having current readings was a step in the right direction. Restoration time improved during faults, where substations were automated.

The optimisation algorithm was designed to be able to include existing automated substations and include them in the Genetic Algorithm to find the optimum locations for different budget values. The previous results always considered a network without any automation and then assume that all Normally Open Points, NOPs, are automated and finally find the optimum locations in addition to the NOPs. This showed how a DSO can look at a network in the initial part of the automation project.

The proposed algorithm allows the existing automated substations to be defined as substations already automated. Hence it was possible to compare results using the existing automated substations against those suggested by the proposed optimisation methodology.

### 6.7.1 FAIDI

Table 6-8 shows the results of the existing substations, NOPs, and both. There are 25 (17%) existing substations that are automated and 16 (11%) NOPs, thus when one adds the existing and the automated, the network will have 41 (28.5%) substations.

Table 6-8. FAIDI for existing substations

<b>Automated substations</b>	<b>Budget Increment (Euro)</b>	<b>FAIDI (min)</b>	<b>Actual Cost (Euro)</b>	<b>Substations to automate (Qty)</b>
No substations automated	0	907.06	0	0
Already automated substations	0	709.62	106,000	25
Normally Open Points to automate	0	764.72	55,000	16
Normally Open Points and substations already automated	0	637.61	164,000	41

As can be seen from the results, for the twenty-five (25) existing automated substations, the value if FAIDI is given as 709.62 minutes. If only the NOPs are considered, the value will be 764.72 minutes. So, the FAIDI for both the NOPs and the existing automated substations will be 637.61 minutes.

The results show that the substations that have been considered for automation on their own gave a better result than if the NOPs were considered. Looking at a network and based on an initial analysis, a DSO engineer will suggest automating first the NOPs, however this may not be the optimum solution. The DSO choice for the 11kV network in Gozo shows that choosing the twenty-five substations provided a better result.

Using the optimisation method presented in this research and assuming that there are no substations automated in the Gozo network, the results obtained are given in Table 6-9.

Table 6-9. FAIDI for the proposed substations

<b>Automated substations</b>	<b>Budget Increment (Euro)</b>	<b>FAIDI (min)</b>	<b>Actual Cost (Euro)</b>	<b>Substations to automate (Qty)</b>
No substations automated	0	907.06	0	0
Already automated substations	0	907.06	0	0
Normally Open Points to automate	0	764.72	55,000	16
Normally Open Points and substations already automated	0	764.72	55,000	16
1	10,000	719.48	10,000	5
2	20,000	688.72	19,000	8
3	30,000	547.64	29,000	11
4	40,000	520.02	40,000	15
5	50,000	491.42	49,000	18
6	60,000	486.69	58,000	21
7	70,000	472.83	70,000	25
8	80,000	441.43	78,000	27
9	90,000	391.30	87,500	30
10	100,000	378.14	97,500	33

Comparing with the FAIDI results calculated when having 25 substations already automated with the NOPs, and looking at the value of 25 proposed substations for automation, given in Table 6-9, the FAIDI result is 472.83 minutes. This value includes the automated NOPs.

The result obtained from the proposed method against the result for the already automated substations, which is 472.83 minutes against 637.61 minutes, indicates that the proposed optimisation method provides an improved value by selecting distinct locations. Hence the improvement achieved is of about 26% .



The cost for such an improvement is  $€55,000 + €70,000 = €125,000$ .

The cost as proposed by the DSO is  $€55,000 + €106,000 = €161,000$ .

As can be seen the savings outcome is  $€161,000 - €125,000 = €36,000$ . This is about 22% savings.

Table 6-10 compares the substation node numbers between those chosen and already automated by the DSO and those being proposed by the optimisation algorithm method. For both, the NOP substations remain the same. It is shown that the locations being proposed most of them are different from those already automated. Only three substations, 22, 94 and 104 have been re-selected.

Table 6-10. FAIDI - Existing and proposed substation names

	No substations automated	Normally Open Points to automate	Existing automated substations	Proposed substations to automate
<b>FAIDI (min)</b>	907.06	764.72	709.62	472.83
<b>Actual Cost (Euro)</b>	0	55,000	106,000	70,000
<b>Substations to automate (Qty)</b>	0	16	25	25
SS_1		97	19	1
SS_2		20	22	6
SS_3		55	23	13
SS_4		57	31	18
SS_5		63	39	22
SS_6		76	49	24
SS_7		78	50	25
SS_8		85	53	28
SS_9		87	58	30
SS_10		87	64	37
SS_11		96	66	43
SS_12		102	71	48
SS_13		108	77	60
SS_14		118	79	61
SS_15		139	91	69
SS_16		141	94	75
SS_17			104	80
SS_18			106	81
SS_19			110	94
SS_20			113	99
SS_21			122	103
SS_22			130	104
SS_23			134	117
SS_24			136	120
SS_25			140	128

The proposed substations in Table 6-10 were applied to a feeder fault that occurred on 4<sup>th</sup> August 2020. Figure 6-13 shows the diagram of the faulted feeder. The faulty cable branch is between the source CB and substation 131. The actual automated substations for this feeder and the proposed substations, instead of the actual, are given in Table 6-11 and shown in Figure 6-13.

In this case, the capital expenditure was reduced from three substations to two substations.

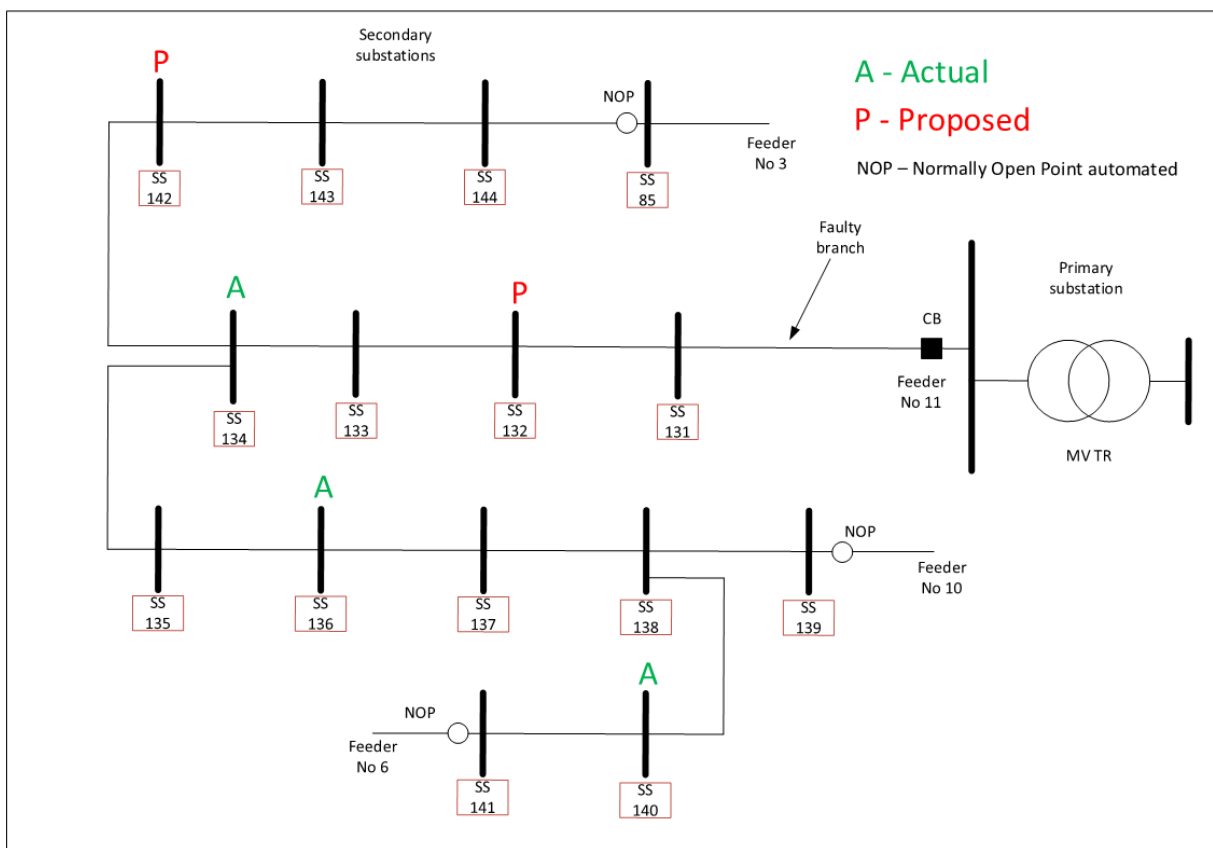

Figure 6-13. Feeder fault between source CB and SS 131

Table 6-11. Proposed substations for automation

Substation with NOP	Substations with existing automation	Proposed Substations for automation
85	134	132
139	136	142
141	140	

The DSO interruption report shows the actual duration of interruption for each substation following a fault. The restoration time given is by using the existing automated substations together with other local operations to restore supply to all customers.

For the same feeder fault, the proposed substations were applied and the restoration time calculated. The remote and local operation time duration required for each substation was taken as the same as that for the actual fault. The results for both are given in Appendix B.

The compared results are summarised in Table 6-12.

Table 6-12. Compared results for an actual feeder fault

	Feeder Transformer rating capacity (kVA)	Total interruption Time (h)	kVA lost (kVA)	No of connected Meters	CML	FAIDI (min)
Existing automated substations	14,050	3.47	3,534.17	3,902	4,0249	10.3149
Proposed substations to be automated	14,050	2.40	2,520.83	3,902	2,5413	6.5128
Difference		1.07	1,013.34		1,4836	3.8021
% Improvement		30.77	28.67		36.86	36.86

Analysing the compared results, show that the customer minutes lost is improved by 36% if the proposed substations are implemented. This is also reflected in the lost kVA, hence the energy cost for the lost load is decreased by 28%.

## 6.7.2 ECOST and maintenance for 15 years

ECOST based on the transformer peak power in kW and maintenance cost, all considered for 15 years, were obtained for the existing automated substations.

Table 6-13 shows the ECOST results obtained for a period of 15 years period.

*Table 6-13. ECOST for 15 years with existing automated substations*

<b>Automated substations</b>	<b>Budget Increment (Euro)</b>	<b>ECOST for 15 years (Euro)</b>	<b>Actual Cost (Euro)</b>	<b>Substations to automate (Qty)</b>
No substations automated	0	759,823.43	0	0
Already automated substations	0	5.19	106,000	25
Normally Open Points to automate	0	12.62	55,000	16
Normally Open Points and substations already automated	0	2.94	161,000	41

The ECOST for fifteen years for the existing automated substations give a result of €5.19 while the NOPs give a result of €12.62. Calculating ECOST for both, the result would be €2.94.

Again, this shows that the locations chosen by the DSO gave a better result than having only the NOPs automated.

Table 6-14. ECOST for 15 years for the proposed automated substations

<b>Automated substations</b>	<b>Budget Increment (Euro)</b>	<b>ECOST for 15 years (Euro)</b>	<b>Actual Cost (Euro)</b>	<b>Substations to automate (Qty)</b>
No substations automated	0	759,823.43	0	0
Already automated substations	0	759,823.43	0	0
Normally Open Points to automate	0	12.62	55,000	16
1	10,000	9.09	10,000	5
2	20,000	7.60	19,000	7
3	30,000	6.22	30,000	11
4	40,000	5.06	40,000	15
5	50,000	4.00	50,000	17
6	60,000	3.94	60,000	19
7	70,000	3.17	69,500	24
8	80,000	2.71	80,000	28
9	90,000	2.29	90,000	30
10	100,000	1.99	100,000	32

Given that the DSO had installed 25 automated substations, it is necessary to compare with the same number of substations being proposed by the optimisation method. The results from the full budget analysis, summarised Table 6-14, gives either 24 or 28 substations. The ECOST values for each are €3.17 and €2.71 respectively.

If 28 substations are considered, the ECOST value is shown as €2.71. There is an improvement from €2.94 to €2.71, which of about 8%.

The cost for such an improvement is €55,000 + €80,000 = €135,000.

The cost as proposed by the DSO is €55,000 + €106,000 = €161,000.

As shown, the savings outcome is €161,000 - €135,000 = €26,000. This is of about 16% savings.

Since 25 substations are not given by the algorithm, linear extrapolation could be used to calculate the ECOST value for 25 substations. The ECOST and the actual cost values calculated, using linear extrapolation, are:

$$ECOST_{25} = 3.17 + (25 - 24) \left( \frac{2.71 - 3.17}{28 - 24} \right) = €3.055$$

$$ACTUAL COST_{25} = 69500 + (25 - 24) \left( \frac{80000 - 69500}{28 - 24} \right) = €72125$$

For the 25 substations, the ECOST value is shown as €3.055. In this case, there is no improvement when compared with the substations installed by the DSO, and there is an increase from €2.94 to €3.055, which is of about 4%.

However, the cost has improved and is €55,000 + €72,125 = €127,125.

The cost as proposed by the DSO is €55,000 + €106,000 = €161,000.

As can be seen, the savings outcome is €161,000 - €127,125 = €33,875. This translates into savings of circa 21%.

Considering the ECOST improvement and the investment savings, between 25 and 28 substations, the DSO can decide to invest slightly more for another three substations reducing the savings but improving the ECOST. However, there is still ample savings that justify the increase in investment.

Table 6-15 compares the substation names between those chosen by the DSO and those proposed by the optimisation algorithm method. For both, the NOP substations are the same. It is shown that different site locations have been chosen by the proposed optimisation method as against those selected by the DSO. In addition three more substations have been proposed for the same budget.



Table 6-15. ECOST - Existing and proposed substation names

	No substations automated	Normally Open Points to automate	Existing automated substations	Proposed substations to automate
<b>ECOST for 15 years (Euro)</b>	759,823.43	5.19	12.62	2.71
<b>Actual Cost (Euro)</b>	0	5,5000	10,6000	80,000
<b>Substations to automate (Qty)</b>	0	16	25	28
SS_1		97	19	4
SS_2		20	22	6
SS_3		55	23	10
SS_4		57	31	11
SS_5		63	39	13
SS_6		76	49	25
SS_7		78	50	26
SS_8		85	53	32
SS_9		87	58	38
SS_10		87	64	40
SS_11		96	66	45
SS_12		102	71	54
SS_13		108	77	58
SS_14		118	79	60
SS_15		139	91	68
SS_16		141	94	73
SS_17			104	80
SS_18			106	90
SS_19			110	94
SS_20			113	104
SS_21			122	110
SS_22			130	122
SS_23			134	123
SS_24			136	128
SS_25			140	129
SS_26				130
SS_27				134
SS_28				135

## 6.8 Summary

The optimisation methodologies presented in Chapters 4 and 5 were applied to a real network as a case study.

The various considerations that have been taken, CML, FAIDI, ECOST, including maintenance cost for 15 years, indicate that it is not necessary to automate all substations in an MV network.

The analysis done on the existing network in Gozo shows that the proposed algorithm, using the Genetic Algorithm, improves the benefits that can be obtained by automating substations. This method gives an improved value from what can be obtained by only considering the DSO practical experience. The optimisation method compliments the DSO knowledge and helps the DSO engineers to locate the optimum substations in an MV network.

The following will summarise the improvement that can be achieved using the proposed methods for analysing a MV network to obtain the optimum substation location where automation can be installed:

- 1) 35% of the network to be automated to have the optimum benefits for the capital cost invested
- 2) Improvement from what a DSO can provide using only its experience will be in the range of 8% to 26% depending which parameters are taken
- 3) Cost savings will be of about 16% if the proposed algorithm is used.
- 4) For an actual feeder fault, the compared results show that CML is improved by 36%
- 5) Less RTUs are required hence less capital and operational expenditure costs. There is no need to fully automate a network

## Chapter 7 - Discussion

### 7.1 Introduction

Power distribution engineering is one of the electrical engineering disciplines in which electrical engineers can specialise. Distribution engineering has been practised for many years worldwide and it is responsible for providing electrical power to nations and continents. It is the backbone of every nation. Distribution system operators are responsible to design, implement and operate distribution networks. These networks have evolved throughout the years and became very complex to operate and maintain. Power systems engineers are always confronted with such challenges and always strive to overcome these challenges. Engineering methods, using newer technologies, have been developed to assist power system engineers to manage distribution networks more efficiently. Early systems introduced telecommands from central control rooms which later evolved to SCADA systems that can manage multiple HV primary substations. Later, distribution management systems were introduced for the MV networks, such as for an 11kV distribution system.

Given that MV networks are more complex and consist of thousands of substations, managing such networks is a greater challenge. At the same time, customers connected to such networks expect a more reliable supply with minimum interruptions. Moreover, when interruptions occur, customers expect that restoration of supply is done in the shortest time possible. Such interruptions do have financial repercussions on connected customers such as commercial and industrial users. At the same time, this is also lost (foregone) revenue to DSOs. So, having systems that minimise the restoration time is an absolute necessity for DSOs.

Several studies and considerable research were carried out to develop planning tools to improve distribution network designs. Various optimisation tools have been developed, all with the intention of improving the operations of MV distributions networks. Each optimisation tool was looked at from different perspectives. The work done in this study considered an innovative approach by considering different operational aspects that power

system engineers encounter while performing switching operations to restore supply back to the affected customers. Site restrictions, that each substation may offer, were also considered. These restrictions have a direct impact on the restoration time. Therefore, considering the challenge that each substation may offer, and by providing a formulation method to represent these restrictions, an optimisation tool was developed, using MATLAB, to identify the most suitable substations where automation may be installed.

## 7.2 Initial concepts for distribution network operations

Following literature review related to improving an MV distribution network operational performance, several avenues were considered. Some have been looking at voltage, load flows and fault level stabilisation by having automation in various locations, others for PV systems penetration but finally, the network performance related to restoration of supply was selected. Although all of them are new experiences that are being faced by a DSO, the major headache is, following a fault, how to restore supply back to all customers within the least possible time.

In Chapter 3 the concept models were developed. Empirical mathematical equations were developed to reflect the site constraints that a distribution network may offer. A small network model was used to test the concept and subsequently, this was used in a case study. The case study looked at a part of a real network. The scope was to be able to rank substations where the ranking system could be used by a DSO to automate the substations. Number of connected customers and the substation importance were other factors considered. All these offered a method where the feeders will also have a ranking system.

The case study for a real network proved that the concept method provides a good indication which substations will have an impact to restore supply, if they are automated. The case study further looked at the lost revenue for the duration of the supply interruption. The outcome was satisfactory and provide the necessary groundwork to explore better methods in the future.

### 7.3 Optimisation methodologies

The concepts developed in Chapter 3 were used in Chapter 4 to build optimisation methods focusing on the customer minutes lost during a supply interruption. Restoration time was split in different operational time to reflect what engineers experience on site. Normal manual switchgear operation time together with duration of arrival time and remote operation from the network control room were taken as the basic switching operation time. This was considered for substations that do not pose any additional restrictions.

For substations that have restrictions, the site access, substation location and the switchgear operational restrictions were considered in addition to the basic switching time when the switching is done locally.

The optimisation methods included such restrictions and to obtain the optimum substation locations the Genetic Algorithm was used to provide the optimum values for the customer minutes lost. Improvement up to 75% were achieved, implying that the CML value was reduced substantially.

### 7.4 Cost of lost energy

What was achieved in Chapters 3 and 4 was further developed in Chapter 5. The cost of energy was calculated by looking at the transformer rating and the transformer peak load. The cost related to the engineer's time required to restore supply was included.

The developed methods were used to analyse three types of networks, having two, three and four feeders, respectively.

1. Considering the transformer rating in kVA, 55% reduction in lost energy cost was realised for the optimum point when 60% of the substations are automated.

2. If the transformer peak power, in kW, is considered, the optimum point indicates that a reduction of 50% is achieved for the lost energy cost with 55% of the substations automated.

A new reliability index was presented, FAIDI. This is like the CAIDI index but presents a better way to express the feeder performance. The analysis done, using this index, concluded that FAIDI will improve by 72% with 65% of the substations automated.

The implementation of substation automation requires an investment that the DSO must factor in its annual financial budget. Return of investment was considered, over a period of 15 years. During the period, maintenance cost was also included. The 15 years time horizon was based on the expected lifetime of the substation automation equipment. The return on investment was viable when 50% of the substations are automated.

## 7.5 Real MV network optimisation

A real network was used in Chapter 6 as a case study to test the optimisation methods developed in Chapters 4 and 5. The data from the 11kV network was used to model the same network in Matlab and then apply the optimisation methods.

The following will summarise the improvement that can be achieved using the proposed methods for analysing an MV network to obtain the optimum substation location where automation can be installed.

1. 35% of the network to be automated to have the optimum benefits for the capital cost invested.
2. Improvement from what a DSO can provide using only its experience will be in the range of 8% to 26% depending which parameters are taken.

3. Cost savings will be about 16% if the proposed algorithm is used.
4. For an actual feeder fault, the compared results show that CML is improved by 36%.
5. Capital and operational expenditure are reduced since not all substations need to be automated.

## 7.6 Summary

The presented methodologies showed that an achievement is possible by reducing the downtime of customers without supply, reducing the lost energy cost and a viable return of investment.

These can be achieved without the need to automate all substations. The research provided the optimum number of substations to be automated on which DSO can invest their money.

Looking at the individual results, all converged towards the same optimised value for the number of substations to be automated. 50% to 60% will be the optimum number of substations to automate obtaining about the same percentage as improvement in CML and cost of lost energy. This was based on the three network models under study.

The case study, for the selected 11kV network, returned a better optimum number of substations, around 26% of the substations, to be automated. Hence less investment is required.

Given that the real network already has some automated substations, comparison was done using the same optimisation methods. These were applied for the existing automated substations and then for the same network assuming that there are no automated substations. The results obtained for the latter showed that there was an improvement of between 8% and 16% and a cost saving of 16% against the present substation. Hence adapting the proposed automated substations from the optimisation method will result in better cost savings and improved network operational performance.

# Chapter 8 - Conclusion

## 8.1 Introduction

When substations' locations are selected as part of a distribution network automation process, a DSO depends on their engineer's experience. Based on this, a DSO will try to provide the necessary investment budget. The availability of a financial budget is not always possible and may be reduced or provided over several years.

At the same time, the located substations may not always be the correct choice, moreover when decisions are taken by non-experienced engineers. Sometimes substations are selected by convenience such as transformer rating or a particular customer.

This study presented a novel approach of how substation locations are achieved to automate a network by achieving improved customer satisfaction and better savings for the DSO. This approach was by including the actual distribution network operational perspective to achieve a better optimisation method.

## 8.2 Important findings

In Chapter 3, feeder and substation ranking method provided a better understanding of where the best locations of substations can be found. The result of this ranking shows that restoration time for the case study was reduced by 27 minutes. For the same case study, the reduction in lost revenue was 79%.

The optimisation methods in Chapter 4:

- Provided an improvement in CML of 75%, hence the CML value was reduced drastically.
- The lost energy cost, when considering the transformer rating, reached a reduction of 55% when the optimum point of 60% of the substations are automated.



- For the transformer peak power, the lost energy cost was reduced by 50% when the optimum number of automated substations was 55%.
- The return of investment was feasible when 50% of the substations are automated.

The case study in Chapter 6 confirmed the improvements achieved in Chapters 4 and 5, which are:

1. 35% of the network must be automated to have the optimum benefits for the capital cost invested.
2. Improvement from what a DSO can provide using only its experience will be in the range of 8% to 26% depending which parameters are taken.
3. Cost savings will be of circa 16% if the proposed algorithm is used.
4. For an actual feeder fault, the compared results show that CML is improved by 36%.
5. Less RTUs are required hence less CAPEX and OPEX costs.

### 8.3 Research objectives

The innovative approach research objectives were fulfilled by

1. Describing how actual restoration time restrictions are identified
2. Develop an optimisation method to include the site restrictions experienced daily
3. Examine and compare optimisation results based on transformer rating and transformer peak power
4. Devise a method where for a given budget provides the optimum substation locations that will eventually provide the optimum values during restoration of supply.
5. The proposed method improved the customer restoration time, hence customer satisfaction ought to be better.

## 8.4 Summary

The primary contribution of the author has been to provide an optimisation method for engineers, irrespective whether they are experienced or otherwise, to evaluate a DSO network and find the optimum locations where substations can be automated so that automation of feeders in distribution network is improved.

## 8.5 Future research

Using this research, it is envisaged that there are other areas that may be candidates for further studies. The following are the main suggested areas where researchers may focus:

1. network with spur branches
2. networks having circuit breakers in some substations
3. more than one source bus
4. include the cable current capacity and check if the shift in load violates the cable capacity
5. the type of cables in the network, their age and history of faults
6. distributed generation, mainly if this is by scattered PV panels on houses. It can be a novel contribution to keep these connected to the LV grid when an MV fault interrupts the supply to several substations during the day and during the night if the PV systems are equipped with battery storage. This means that switching location must quickly isolate the substation transformers and switch on a reference voltage and frequency on the LV network so that PV panels can synchronise back on the network and provide some power to nearby customers.

## References

- [1] Regulator for Energy and Water Services, "2019 Annual Report of the Regulator for Energy and Water Services to the European Commission on the national energy sector in Malta," 2019.
- [2] Regulator for Energy and Water Services, "2020 Annual Report of the Regulator for Energy and Water Services to the European Commission on the electricity and natural gas sector in Malta," 2020.
- [3] IEEE Standards Association, "IEEE Guide for Electric Power Distribution Reliability Indices," *IEEE Std 1366-2012 (Revision of IEEE Std 1366-2003)*, pp. 1-43, 2012.
- [4] J. McDaniel, W. Friedl and H. Caswell, "Benchmarking of reliability: North American and European experience," in *Proceedings of the 23th International Conference on Electricity Distribution, Lyon, France, 2015*, pp. 15-18.
- [5] Energy Networks Association, "Electricity Network Innovation Strategy," pp. 1-25, March, 2020.
- [6] I. 1994-2019 The MathWorks, "MATLAB," vol. R2019a, 1994-, 2019.
- [7] B. Solano Rodriguez, P. Drummond and P. Ekins, "Decarbonizing the EU energy system by 2050: an important role for BECCS," *Climate Policy*, vol. 17, (*sup1*), pp. S93-S110, 2017.
- [8] B. Ruben *et al*, "Meshing radial networks at 11kV," in *2011 2nd IEEE PES International Conference and Exhibition on Innovative Smart Grid Technologies*, 2011, pp. 1-8.
- [9] J. M. Bloemink and T. C. Green, "Benefits of distribution-level power electronics for supporting distributed generation growth," *IEEE Trans. Power Del.*, vol. 28, (2), pp. 911-919, 2013.
- [10] J. M. Bloemink and T. C. Green, "Increasing distributed generation penetration using soft normally-open points," in *IEEE PES General Meeting*, 2010, pp. 1-8.
- [11] T. Frost, P. D. Mitcheson and T. C. Green, "Power electronic voltage regulation in LV distribution networks," in Jun 2015, Available: <https://ieeexplore.ieee.org/document/7223039>. DOI: 10.1109/PEDG.2015.7223039.
- [12] I. Sarantakos *et al*, "A reliability-based method to quantify the capacity value of soft open points in distribution networks," *IEEE Trans. Power Syst.*, vol. 36, (6), pp. 5032-5043, 2021.

- [13] I. Sarantakos *et al*, "A robust mixed-integer convex model for optimal scheduling of integrated energy storage—soft open point devices," *IEEE Transactions on Smart Grid*, vol. 13, (5), pp. 4072-4087, 2022.
- [14] G. Bathurst, G. Hwang and L. Tejwani, "MVDC - the new technology for distribution networks," in 2015, Available: <http://digital-library.theiet.org/content/conferences/10.1049/cp.2015.0037>. DOI: 10.1049/cp.2015.0037.
- [15] A. Canova *et al*, "Electrical impact of photovoltaic plant in distributed network," *IEEE Trans. Ind. Appl.*, vol. 45, (1), pp. 341-347, 2009.
- [16] F. M. Gatta *et al*, "Reactive power control strategy for voltage regulation and power-factor correction in MV distribution networks," in *2015 IEEE Eindhoven PowerTech*, 2015, pp. 1-6.
- [17] R. D. Zimmerman, C. E. Murillo-Sánchez and R. J. Thomas, "MATPOWER: Steady-state operations, planning, and analysis tools for power systems research and education," *IEEE Trans. Power Syst.*, vol. 26, (1), pp. 12-19, 2010.
- [18] S. Eilenberger *et al*, "Probabilistic simulation for LV-grid optimization with new network components," 2013.
- [19] A. F. Povlsen, "Impacts of power penetration from photovoltaic power systems in distribution networks," *Report IEA PVPS T5-10*, vol. 2002, 2002.
- [20] S. M. Blair *et al*, "Increasing distribution network capacity using automation to reduce carbon impact," 2014.
- [21] S. Blair and C. Booth, "Analysis of the technical performance of C2C operation for HV networks," Tech. Rep. STRATH/ENW/C2C/033, December, . 2014.
- [22] E. A. M. Ceseña, P. Mancarella and V. Turnham, "Demand Response in Smart Distribution Network Planning: Regulatory Trade-offs between Capital and Social Costs," .
- [23] J. Broderick, "Capacity to Customers (C2C) Carbon Impact Assessment Final Assessment Report," pp. 1-12, 2015.
- [24] V. Turnham and P. Turner, "Capacity to customers second tier LCN fund project closedown report," March 13, . 2015.
- [25] DNV KEMA Energy & Sustainability, "Review of network benefits of smart meter message flows," April 30, . 2013.
- [26] M. Patsalides *et al*, "Thevenin equivalent circuit for the study of high photovoltaic penetration in distribution grids," in *IEEE PES ISGT Europe 2013*, 2013, pp. 1-5.

- [27] R. Tonkoski and L. A. Lopes, "Impact of active power curtailment on overvoltage prevention and energy production of PV inverters connected to low voltage residential feeders," *Renewable Energy*, vol. 36, (12), pp. 3566-3574, 2011.
- [28] Jiang Tianxiang, Wang Pengfei, Lyons Pdraig, Liang Daniel, "EES3 autonomous voltage control," *Customer-Led Network Revolution*, December 29,. 2014.
- [29] P. Wang and P. Lyons, "EES2 autonomous voltage control at wooler ramsey," *Customer-Led Network Revolution*, July 7,. 2014.
- [30] Wilcox Martin, "Demonstrating the benefits of short-term discharge energy storage on an 11kV distribution network UK power networks," *UK Power Networks*, June 6,. 2014.
- [31] M. Wilcox, "Observations on flexibility and automation," *UK Power Networks*, April,. 2014.
- [32] R. Thompson and S. Carter, "Distribution network visibility low carbon networks fund tier 1 project," *UK Power Networks*, 2011.
- [33] A. Bonhomme *et al*, "A new voltage control system to facilitate the connection of dispersed generation to distribution networks," in *16th International Conference and Exhibition on Electricity Distribution, 2001. Part 1: Contributions. CIRED.(IEE Conf. Publ no. 482)*, 2001, pp. 10 pp. vol. 4.
- [34] L. Leite *et al*, "Integrated voltage regulation in distribution grids with photovoltaic distribution generation assisted by telecommunication infrastructure," *Electr. Power Syst. Res.*, vol. 136, pp. 110-124, 2016.
- [35] M. Cepin, "Method for assessing reliability of a network considering probabilistic safety assessment," in *Nuclear Energy for New Europe 2005*, Bled, Slovenia, September 5-8, 2005, pp. 1-8.
- [36] G. Song, H. Chen and B. Guo, "A layered fault tree model for reliability evaluation of smart grids," *Energies*, vol. 7, (8), pp. 4835-4857, 2014.
- [37] Reepe Robert, "The Right Device in the Right Location," *T&D World Magazine*, Oct. 29,. 2014.
- [38] G. Sapienza, "Voltage Control in MV Networks with High DG Presence using a Real-Time Digital Simulator." , Politecnico Milano, Italy, 2012.
- [39] Y. Hou, "Impact on Voltage Rise of Photovoltaic Generation in Swedish Urban Areas with High PV Population." , 2013.
- [40] R. N. Allan *et al*, "A reliability test system for educational purposes-basic distribution system data and results," *IEEE Trans. Power Syst.*, vol. 6, (2), pp. 813-820, 1991.

- [41] S. Chouhan, H. Inan and A. Feliachi, "Optimal number and placement of automated sectionalizing switches for smart grid distribution automation," in *2016 IEEE Power and Energy Society General Meeting (PESGM)*, 2016, pp. 1-5.
- [42] C. Weiwei, W. Yafeng and L. Wenxia, "Optimal allocation of switches in DG enhanced distribution systems," in *2011 Asia-Pacific Power and Energy Engineering Conference*, 2011, .
- [43] B. Pang *et al*, "A study on optimal switching decision of distribution network based on influence diagrams," in *2011 International Conference on Electrical and Control Engineering*, 2011, pp. 4328-4331.
- [44] R. Billinton and S. Jonnavithula, "Optimal switching device placement in radial distribution systems," *IEEE Trans. Power Del.*, vol. 11, (3), pp. 1646-1651, 1996.
- [45] G. D. Ferreira and A. S. Bretas, "A nonlinear binary programming model for electric distribution systems reliability optimization," *International Journal of Electrical Power & Energy Systems*, vol. 43, (1), pp. 384-392, 2012.
- [46] H. Sekhavatmanesh and R. Cherkaoui, "Optimal infrastructure planning of active distribution networks complying with service restoration requirements," *IEEE Transactions on Smart Grid*, vol. 9, (6), pp. 6566-6577, 2017.
- [47] M. Khani and A. Safdarian, "Effect of sectionalizing switches malfunction probability on optimal switches placement in distribution networks," *International Journal of Electrical Power & Energy Systems*, vol. 119, pp. 105973, 2020.
- [48] S. Ray, A. Bhattacharya and S. Bhattacharjee, "Optimal placement of switches in a radial distribution network for reliability improvement," *International Journal of Electrical Power & Energy Systems*, vol. 76, pp. 53-68, 2016.
- [49] I. Sarantakos *et al*, "Incorporating asset management into power system operations," *CIREN - Open Access Proceedings Journal*, vol. 2017, (1), pp. 1227-1231, 2017. . DOI: 10.1049/oap-cired.2017.0649.
- [50] I. L. SpA and O. B. SrL, "Regulation of continuity of supply in the electricity sector and cost of energy not supplied," 2009.
- [51] I. Sarantakos, "Investigating the Impact of Asset Condition on Distribution Network Reconfiguration and its Capacity Value." , Newcastle University, 2019.
- [52] E. Antila, P. Heine and M. Lehtonen, "Economic analysis of implementing novel power distribution automation," in *CIGRE/IEEE PES International Symposium Quality and Security of Electric Power Delivery Systems, 2003. CIGRE/PES 2003*. 2003, pp. 121-126.
- [53] C. Su and J. Teng, "Economic evaluation of a distribution automation project," in *Conference Record of the 2006 IEEE Industry Applications Conference Forty-First IAS Annual Meeting*, 2006, pp. 1402-1409.

- [54] K. Du Plessis, "Return of Investment vs. Return on Investment," *Https://Optionalpha.Com/Learn/Return-of-Investment-Vs-Return-on-Investment*, Aug, 2021.
- [55] (July). *Genetic Algorithm*. Available: <https://uk.mathworks.com/help/gads/how-the-genetic-algorithm-works.html>.

## Appendix A      MATLAB Genetic Algorithm

The Genetic Algorithm [51], [55] was used in MATLAB [6] to find the optimum substations locations where MV switchgear could be automated.

This is a method to solve optimisation problems that are either constrained or non-constrained. It is based on the process that drives the biological evolution. For each process, the genetic algorithm randomly selects individuals to be parents who then produce children for the next generation. The population evolves, after successive generations, to an optimal solution.

The Genetic Algorithm commences by creating a random initial population. For this research, the initial population was defined for the existing automated substations and the normally open points.

A sequence of new populations considering the initial defined substations and creates the next population of substations. This is done as follows:

1. Scores each member of the current population by computing its fitness value. These values are called the raw fitness scores.
2. Scales the raw fitness scores to convert them into a more usable range of values. These scaled values are called expectation values.
3. Selects members, called parents, based on their expectation.
4. Some of the individuals in the current population that have lower fitness are chosen as elite. These elite individuals are passed to the next population.
5. Produces children from the parents. Children are produced either by making random changes to a single parent mutation or by combining the vector entries of a pair of parents crossover.
6. Replaces the current population with the children of the next generation.



The GA process flow is shown in Figure A-1.

Once any of the stopping criteria is met, the genetic algorithm stops. Figure A-2 shows a GA process.

The GA function requires the following:

1. lower bound (lb)
2. upper bound (ub)
3. generation limits (StallGenLimit)

The lower bound defines, randomly, the initial proposed population. In this research, there are substations which are candidates for automation. If a network has several substations already automated, then these must be set in the lower bound.

The upper bound is the maximum size of the population. For a distribution network this is the number of substations that the network has.

StallGenLimit was set at 20; the GA stops when there has been no improvement in the objection function over the last 20 generations.

The GA is run many times, between 3 and 5 times, to check and ensure that the same results are achieved. However, given that optimisation of the automated locations is stochastic in nature, the results do not converge precisely to the same results, the average of all results is taken as the final result.

Typical GA parameters are shown in Table A-1. The population size depends on the number of substations in a network. The number of variables is those substations that are possible candidates to be automated.

*Table A-1. Typical GA parameters*

<b>Parameter</b>	<b>Value</b>
Number of Variables	Candidate substations for automation
Population Size	Substation nodes
Maximum Generations	100
Maximum Stall Generations	20
Number of Runs	5

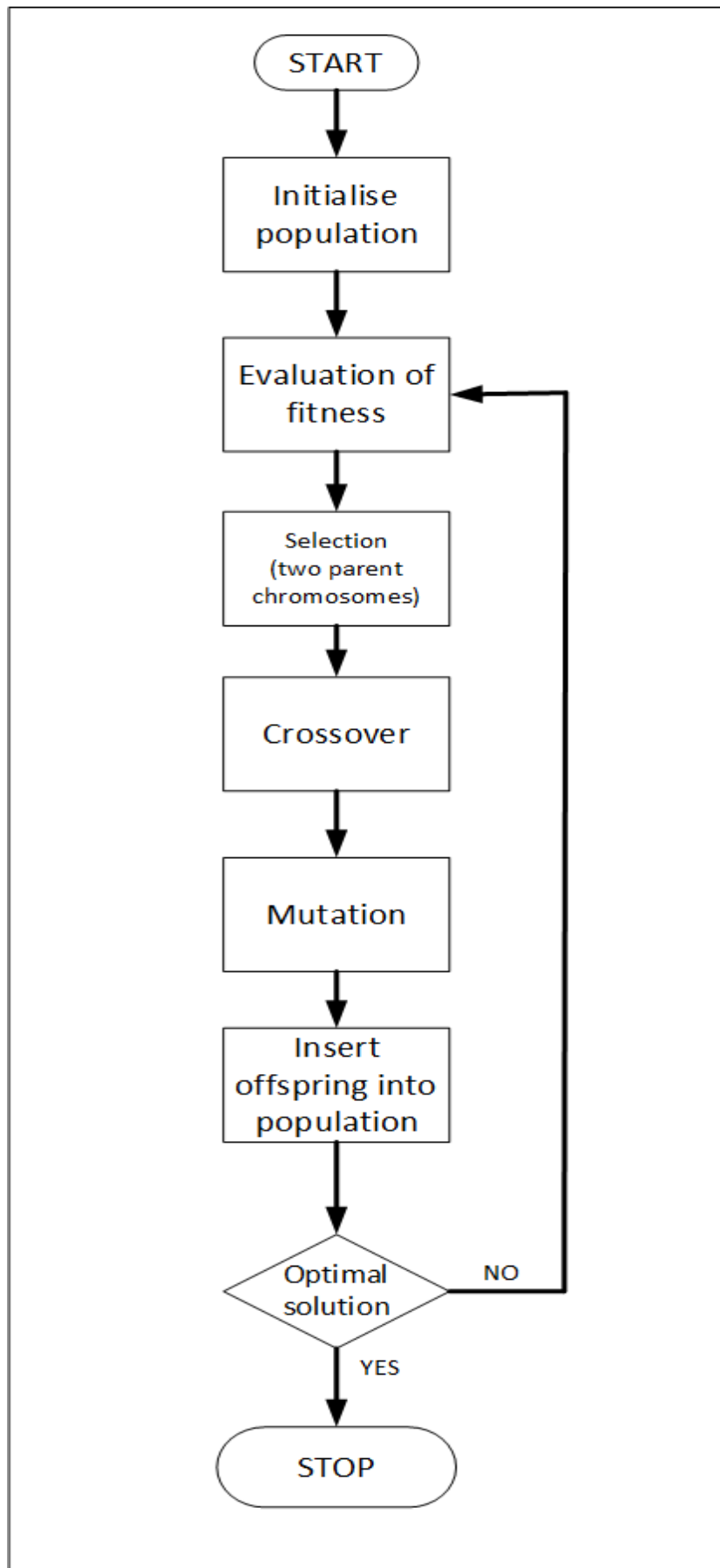

Figure A-1. GA Flow chart

Generation	Func-count	Best Penalty	Mean Penalty	Stall Generations
1	200	0.6423	6.001e+07	0
2	300	0.5783	3.1e+07	0
3	400	0.5783	2.2e+07	1
4	500	0.5783	2.3e+07	2
5	600	0.5783	1.8e+07	3
6	700	0.5783	1.2e+07	4
7	800	0.5783	7.001e+06	5
8	900	0.5783	1e+06	6
9	1000	0.5783	0.6051	7
10	1100	0.5783	0.5807	8
11	1200	0.5783	0.5783	9
12	1300	0.5783	0.5783	10
13	1400	0.5783	0.5783	11
14	1500	0.5783	0.5783	12
15	1600	0.5783	0.5783	13
16	1700	0.5783	0.5783	14
17	1800	0.5783	0.5783	15
18	1900	0.5783	0.5783	16
19	2000	0.5783	0.5783	17
20	2100	0.5783	0.5783	18
21	2200	0.5783	0.5783	19
22	2300	0.5783	0.5783	20

Optimization terminated: average change in the penalty fitness value less than options.FunctionTolerance and constraint violation is less than options.ConstraintTolerance.

Figure A-2. Copy of a Genetic Algorithm process.

## Appendix B Case Study, FAIDI applied to an 11kV feeder fault

For the case study, FAIDI was calculated for an actual feeder fault that occurred on 4<sup>th</sup> August 2020. This was calculated for both the existing automated substations and for the proposed automated substations. The automated substations for both scenarios are provided in Table B-1.

The results for the existing automated substations are given in Table B-2, while the results for the proposed automated substations are given in Table B-3.

The substation that does not have a node number but is indicated with an ‘\*’, is a new substation that was commissioned after the research model was created. When comparing the results this does not affect the outcome since it has the same weighting for both results.

*Table B-1. Automated substations node numbers*

NOP substations	Actual automated substations	Proposed automated substations
85	134	132
139	136	142
141	140	

Table B-2. Results for a branch fault with existing automated substations

Date	Type of Fault	Type of Protection	Reason of Fault	Node No	Locality	Substation	Transformer Rating	Time Out	Time In	Actual time Hours	KVA Lost	No of Meters	CML
04/08/2020	Underground	Earth Fault	H.V. Joints	138	VICTORIA	VICTORIA S/S	1500	11:12	11:17	0.08	125.00	820	4,100.00
04/08/2020	Underground	Earth Fault	H.V. Joints	140	VICTORIA	HOSPITAL S/S	1600	11:12	11:17	0.08	133.33	384	1,920.00
04/08/2020	Underground	Earth Fault	H.V. Joints	139	VICTORIA	VICT. HOS S/S	750	11:12	11:17	0.08	62.50	568	2,840.00
04/08/2020	Underground	Earth Fault	H.V. Joints	137	VICTORIA	ADMIN. S/S	800	11:12	11:17	0.08	66.67	382	1,910.00
04/08/2020	Underground	Earth Fault	H.V. Joints	135	VICTORIA	ASTRA S/S	1600	11:12	11:17	0.08	133.33	235	1,175.00
04/08/2020	Underground	Earth Fault	H.V. Joints	141	VICTORIA	Child Care Centre Dev.	500	11:12	11:17	0.08	41.67	2	10.00
04/08/2020	Underground	Earth Fault	H.V. Joints	136	VICTORIA	Cittadella	1000	11:12	11:17	0.08	83.33	249	1,245.00
04/08/2020	Underground	Earth Fault	H.V. Joints	*	VICTORIA	Medical School	1000	11:12	11:17	0.08	83.33	1	5.00
04/08/2020	Underground	Earth Fault	H.V. Joints	134	VICTORIA	CAPUCCHIN S/S	1000	11:12	11:24	0.20	200.00	659	7,908.00
04/08/2020	Underground	Earth Fault	H.V. Joints	142	VICTORIA	M`FORN P.STN. S/S	100	11:12	11:24	0.20	20.00	19	228.00
04/08/2020	Underground	Earth Fault	H.V. Joints	143	VICTORIA	M`FORN RD. T.C.	250	11:12	11:24	0.20	50.00	21	252.00
04/08/2020	Underground	Earth Fault	H.V. Joints	144	XAGHRA	GHAJN DAMMA T.C.	250	11:12	11:24	0.20	50.00	1	12.00
04/08/2020	Underground	Earth Fault	H.V. Joints	133	VICTORIA	GOZO COLLEGE S/S	1600	11:12	11:40	0.47	746.67	443	12,404.00
04/08/2020	Underground	Earth Fault	H.V. Joints	132	VICTORIA	DOWNTOWN S/S	500	11:12	11:51	0.65	325.00	1	39.00
04/08/2020	Underground	Earth Fault	H.V. Joints	131	VICTORIA	ARKADIA S/S	1600	11:12	12:05	0.88	1,413.33	117	6,201.00
Total							14050			3.47	3,534.17	3902	40,249.00

Table B-3. Results for the same branch fault but with the proposed automated substations

Date	Type of Fault	Type of Protection	Reason of Fault	Node No	Locality	Substation	Transformer Rating	Time Out	Time In	Actual time Hours	KVA Lost	No of Meters	CML
04/08/2020	Underground	Earth Fault	H.V. Joints	138	VICTORIA	VICTORIA S/S	1500	11:12	11:17	0.08	125.00	820	4,100.00
04/08/2020	Underground	Earth Fault	H.V. Joints	140	VICTORIA	HOSPITAL S/S	1600	11:12	11:17	0.08	133.33	384	1,920.00
04/08/2020	Underground	Earth Fault	H.V. Joints	139	VICTORIA	VICT. HOS S/S	750	11:12	11:17	0.08	62.50	568	2,840.00
04/08/2020	Underground	Earth Fault	H.V. Joints	137	VICTORIA	ADMIN. S/S	800	11:12	11:17	0.08	66.67	382	1,910.00
04/08/2020	Underground	Earth Fault	H.V. Joints	135	VICTORIA	ASTRA S/S	1600	11:12	11:17	0.08	133.33	235	1,175.00
04/08/2020	Underground	Earth Fault	H.V. Joints	141	VICTORIA	Child Care Centre Dev.	500	11:12	11:17	0.08	41.67	2	10.00
04/08/2020	Underground	Earth Fault	H.V. Joints	136	VICTORIA	Cittadella	1000	11:12	11:17	0.08	83.33	249	1,245.00
04/08/2020	Underground	Earth Fault	H.V. Joints	*	VICTORIA	Medical School	1000	11:12	11:17	0.08	83.33	1	5.00
04/08/2020	Underground	Earth Fault	H.V. Joints	134	VICTORIA	CAPUCCHIN S/S	1000	11:12	11:17	0.08	83.33	659	3,295.00
04/08/2020	Underground	Earth Fault	H.V. Joints	142	VICTORIA	M`FORN P.STN. S/S	100	11:12	11:24	0.20	20.00	19	228.00
04/08/2020	Underground	Earth Fault	H.V. Joints	143	VICTORIA	M`FORN RD. T.C.	250	11:12	11:24	0.20	50.00	21	252.00
04/08/2020	Underground	Earth Fault	H.V. Joints	144	XAGHRA	GHAJN DAMMA T.C.	250	11:12	11:24	0.20	50.00	1	12.00
04/08/2020	Underground	Earth Fault	H.V. Joints	133	VICTORIA	GOZO COLLEGE S/S	1600	11:12	11:17	0.08	133.33	443	2,215.00
04/08/2020	Underground	Earth Fault	H.V. Joints	132	VICTORIA	DOWNTOWN S/S	500	11:12	11:17	0.08	41.67	1	5.00
04/08/2020	Underground	Earth Fault	H.V. Joints	131	VICTORIA	ARKADIA S/S	1600	11:12	12:05	0.88	1,413.33	117	6,201.00
Total							14050			2.40	2520.83	3902	25,413.00