

Auditory Cognition
in
Alzheimer's Disease

Meher Lad



PhD Thesis

Newcastle University
Biosciences Institute

2023

Acknowledgements

The work that I have conducted in this fellowship would not be possible without a lot of serendipity and perseverance over the last few years. I thank the lucky accidents that brought me to Newcastle, such as obtaining an NIHR Academic Clinical Fellowship in Neurology and then the Guarantors of Brain Entry Fellowship, where I thank the psychology of first impressions more than anything else that followed. The same could be said for my MRC fellowship interview. I would not have had the opportunity to have an interview if it wasn't for the grantsmanship that was particularly honed by my first supervisor, Prof. Tim Griffiths. Subsequently, i've had the pleasure of being supervised by Prof. John-Paul Taylor who has been crucial for developing my links with Old Age Psychiatry.

I thank the biggest lucky accident for me, the Covid pandemic. What turned out to be disastrous for many around the world, was tremendously beneficial for me (despite my research being halted for 2 years). I was able to learn skills and qualities about myself that will help in my future career. The pandemic virtualised resources that truly transformed my computing and scientific knowledge and that is the main reason I feel comfortable in research currently. YouTube and the online research community became my closest friends and accelerated my research. I found virtual mentors, tutors, motivators and friends which kept me going. This thesis only contains about half of the work I have actually carried out as it is focussed on what I said I would do for my MRC fellowship.

My family was and is the calm of the storm of daily life and I thank my lovely wife Nadia for her patience everyday. She is the best parent to our lovely boys Sasha and Oscar and I love them all dearly! Thank you all for supporting me despite me thinking about work constantly!

Abstract

Mounting evidence suggests a significant association between hearing loss and an elevated risk of dementia, yet its neurobiological underpinnings remain largely unknown. A decline in the central auditory processing ability, particularly, has been implicated in the increased susceptibility to Alzheimer's Disease dementia. The research presented in this dissertation highlights the importance of auditory cognitive mechanisms such as speech-in-noise perception and auditory memory, in two demographic cohorts: ageing individuals who are cognitively intact and those afflicted with Alzheimer's disease, which includes those exhibiting mild cognitive impairment and Alzheimer's Disease dementia.

Employing an array of different experimental paradigms and methodologies, I present evidence that highlights the critical role of short-term auditory memory (spanning tens of seconds) in speech-in-noise perception, an ability that diminishes across the Alzheimer's Disease continuum. Evaluating this auditory cognitive ability can serve as a valuable instrument for understanding the functionality of the medial temporal lobe, as corroborated by neuropsychological and neuroanatomical work demonstrated in this thesis and functional imaging work conducted in healthy volunteers. To fully substantiate these findings and gauge their generalisability, it is imperative to conduct longitudinal studies to ascertain the validity and reliability of these observations in diverse participant cohorts.

Table of Contents

| | |
|---|------------|
| Acknowledgements | 2 |
| Abstract | 3 |
| 1. Introduction | 5 |
| 2. General Principles, Background and Methodology | 12 |
| 3. Subjective Hearing Loss and Risk of Dementia | 33 |
| 4. Speech-in-Noise Perception and Auditory Memory in Ageing | 55 |
| 5. Speech-in-Noise Perception and Auditory Memory in Alzheimer's Disease Dementia | 75 |
| 6. Neuroanatomy of Auditory Cognition in Health and Alzheimer's Disease Dementia | 93 |
| 7. Functional Neuroanatomy of Auditory Memory Precision | 109 |
| 8. Summary and Conclusions | 123 |
| References | 128 |
| Glossary | 145 |

1. Introduction

1.1. The problem

Hearing loss is one of the major risk factors for dementia but the reasons for this are unclear (Livingston et al., 2020). Ageing increases the risk of both hearing loss and dementia and so it is important to clarify the nature of the link between them. Ageing leads to a number of changes in the ear, the connecting pathways to the brain and the brain itself which can manifest as different forms of hearing difficulties. Disentangling the way these changes can contribute to dementia therefore requires a good understanding of the breadth of hearing abilities in ageing that are not associated with the condition and vice-versa. The overarching goal of this thesis is to understand which hearing abilities may be most informative about early dementia processes and its neuroscientific basis.

There are several mechanisms by which ageing, hearing loss and dementia are related. Firstly, the same neurobiological processes could underlie dementia and hearing loss (Griffiths et al., 2020; Johnson et al., 2021). In this suggestion one would observe the same neuropathological proteins affecting key auditory brain regions, such as the auditory cortices and association pathways. Depending on the progression of dementia and hearing loss, these effects may be an early indicator of the disease. Hearing loss could also reduce resilience against dementia by causing a strain on brain resources for everyday hearing or brain pathways for other cognitive abilities that are diverted to support impoverished hearing (Lad et al., 2022). Another explanation could be that hearing loss causes secondary indirect effects on the brain by causing social isolation and low mood, which in turn lead to an increased dementia risk (Slade et al., 2020).

This thesis examines the first mechanism which proposes that there may be shared mechanisms affecting hearing and changes that occur in an individual's brain that puts them at risk of dementia. Certain hearing abilities may be a manifestation of early dementia itself which is separate from ageing, and related to the neurodegenerative process underlying the dementia. As ageing does have an effect on all aspects of the hearing system it may be that a combination of hearing measurements that are related to ageing and those related to the neuropathology of dementia are needed to better understand this link. This thesis focuses on the most common

form of dementia, late-onset typical Alzheimer's Disease (AD) dementia, which is arguably the best characterised with demographic, neuropsychological, neuroimaging and biochemical data. I will investigate whether specific auditory functions of the brain can shed light on connections to AD dementia, from a cognitive and neuroanatomical standpoint.

1.2. Poor central hearing increases the risk of dementia

Recent meta-analyses have focussed on the link between hearing loss, measured by a test called the pure-tone audiogram (PTA), and subsequent risk of dementia (Livingston et al., 2020). People in mid-life and later-life who had their PTA thresholds measured at baseline were followed up for up to 12 years in some cases, and those classified as having poor PTA scores were more likely than those with normal hearing to be diagnosed with dementia. Although some of these studies used a clinical definition of 'all-cause' dementia, in other cases clinical coding was used. The PTA is a test of peripheral hearing function, whereas all neurodegenerative dementias are brain cognitive disorders. Therefore, as will be discussed in the next chapter in more detail, it is difficult to reconcile how there might be a direct overlap between hearing pathways and the neuropathological process underlying dementia.

Theoretical models posit that central hearing may better capture the link between hearing loss and dementia after accounting for the effect of peripheral measures (Griffiths et al., 2020; Marinelli et al., 2022). There have been several studies that have described central auditory impairments in people at risk of dementia (Johnson et al., 2021). When some measures of Speech-in-Noise (SiN) perception ability are used alongside PTA thresholds, the predictive value of SiN on dementia risk remains (Eastwood and Corbin-Rifat, 1989; Loughrey, 2022). A large prospective cohort study, with over 1000 individuals from the Framingham Heart Study, established that SiN perception ability, measured using a dichotic sentence identification task, provided a risk ratio of 23.3 after adjusting for age, sex, education, APOE status and pure-tone audiometry results (Gates et al., 2002). More recent data from the UK Biobank participants has shown impairments in SiN ability increase dementia risk in a dose-dependent manner (Stevenson et al., 2022). Some studies have also indicated that this risk may be more evident using particular kinds of SiN stimuli (Mohammed et al., 2022).

1.3. Brain pathways of hearing and their relevance to dementia

After sound is relayed to the outer ears by air waveforms, it is amplified by the outer and inner ear before this information is transmitted to the nervous system via the auditory nerve. The cochlea, in the inner ear, acts as a transducer of sound input into frequency based information. The cochlea then passes this auditory information to an array of processing units in the brainstem, where timing and spatial information is integrated and then sent to regions in the brain where the information is processed further. The primary auditory cortex aids processing of auditory features, such as frequency, and the adjacent association cortices in the temporal and parietal lobes support higher-order processes like auditory grouping or segregation. This ability helps people identify and track different elements of an auditory scene known as auditory objects (Griffiths and Warren, 2004). Although this overview provides a simplistic bottom-up account of how sounds may be processed by the human body, it shows that there are important neuroanatomical structures that can be interrogated to study if dementia-related neuropathology is present here.

Neuropathological studies have indicated that AD-related neuropathology can reliably be detected in the higher auditory brain in early AD dementia. There is evidence for AD neuropathological changes being present in the early auditory nervous system such as the central nucleus of the inferior colliculus in the brainstem and the ventral nucleus of the medial geniculate body of the thalamus (Sinha et al., 1993). Synaptic alterations in these regions, manifesting as decreased spine density, may also be seen without any AD neuropathologic change in cases of AD dementia when compared to healthy matched controls (Baloyannis et al., 2009). The proportion of neurofibrillary tangles (NFT) is larger in deeper layers of the auditory association cortices (Brodmann Area 22) than the primary auditory cortex (Brodmann Area 20), representing almost a 10-fold increase (Lewis et al., 1987). This finding has also been corroborated by other groups (Esiri et al., 1986). These studies indicate that there is relative sparing of neuropathology in the primary auditory cortex as compared to the association cortices. Therefore, neuropathology does not seem to ascend through the auditory hierarchy in a way similar to how sound is processed but conforms to Braak stages (Braak and Braak, 1991).

The above neuroanatomical knowledge can be applied to distinguish people with and without AD dementia as evidence suggests that auditory processing abilities beyond perception are

useful in separating these groups. Cross-sectional work has demonstrated previously that auditory cognitive tasks using SiN tasks can be used to identify group level differences between people without dementia, those with mild cognitive impairment of uncertain aetiology and AD dementia (Idrizbegovic et al., 2011). The process of auditory scene analysis, where different elements of auditory input need to be identified, is also impaired (Goll et al., 2012). This work showed poor group-level performance for people with AD dementia for tasks assessing auditory object segregation and grouping, using synthetic complex sound stimuli below the level of speech, conventionally associated with temporal regions of the brain. Deficits in processing spatial auditory stimuli using paradigms testing sound discrimination for motion, external perception or position have also been related to structural changes in parietal lobe regions in AD dementia (Golden et al., 2015). It is unclear whether these changes reflect widespread disease in AD dementia patients or whether these tests provide additional value separate from clinical and neuropsychological assessment. However, the evidence suggests that these tests are promising cognitive biomarkers of AD.

1.4. The Hearing Hippocampus in Health and Disease

The medial temporal lobe is one of the earliest sites affected by AD neuropathology and deposition of NFTs in this region correlates with cognitive symptoms (Bejanin et al., 2017). Episodic memory deficits and evidence of structural changes in this brain region form part of the diagnostic criteria for AD dementia (Jack et al., 2018). Therefore, there has been considerable interest in developing tests that are sensitive and specific for 'damage' to this region (Lowndes and Savage, 2007). Although neuropsychological tests have mostly used visual and verbal stimuli to build this evidence, a large body of work supports hippocampal contributions during auditory processing for non-speech sounds (Billig et al., 2022). Whether the latter can provide a similar value to traditional neuropsychological tests assessing medial temporal lobe function has not been studied in detail.

Neuroanatomy highlighting auditory connections to the hippocampus is an under-researched area but evidence is building to support this assertion. In rodents, direct subcortical projections have been found to the hippocampal formation and another via the thalamus (Bordi and LeDoux, 1994; Zhang et al., 2018). Evidence from primates shows that areas at the top of the auditory hierarchy also project to the hippocampus indirectly (Munoz-Lopez et al., 2010).

Detailed anatomical studies are lacking in humans but advanced neuroimaging techniques such as Diffusion Tensor Imaging (DTI) has revealed possible connections between the hippocampus and the auditory cortices (Jang and Choi, 2022). Human intracranial electroencephalography (iEEG), in people with intractable epilepsy undergoing a workup for neurosurgery, has also revealed strong high-frequency coupling between the medial temporal sites, including the hippocampus, and the auditory cortex during a resting state (Banks et al., 2023).

Other literature emphasises a complex interaction between the auditory and limbic regions (Kraus and Canlon, 2012). There is developing evidence that suggests both peripheral and central hearing loss can either affect or modulate medial temporal lobe structure and function. Poor peripheral hearing measures have been linked to changes in hippocampal volume and functional connectivity (Fitzhugh and Pa, 2022). Similar evidence from large prospective cohorts has been found using SiN perception measures like the Digit Triplets Test (Wang et al., 2022a). There have also been associations of central hearing measures and Tau neurodegenerative markers suggesting this link may be driven by neurodegeneration (Tuwaig et al., 2017). Although the direct molecular or neuroscientific mechanisms are unclear currently, cognitive deficits due to hearing loss may be linked to hippocampal dysfunction, increased Tau phosphorylation, neuroinflammation and redox imbalance (Paciello et al., 2021). It is also possible that top-down functional connections from the medial temporal lobe to auditory cortices may mediate SiN perception deficits in AD patients and may play a much larger role for auditory function than previously anticipated (Dhanjal et al., 2013).

1.5. Thesis Structure

The five chapters of this thesis present work that was performed to understand how central auditory abilities, specifically those involved in SiN perception, are impacted in AD dementia through different methodologies. This thesis aims to first provide cognitive neuroscientific explanations for SiN ability in older adults using various hearing and demographic measures and then study how this is affected in AD. Links with brain structures like the medial temporal lobe may support auditory cognitive functions like auditory memory, the ability to keep sounds in mind for seconds, and this can provide a window into cognitive impairment across the AD continuum. I aim to show that auditory memory is a crucial component of SiN ability, and that

this is likely due to its association with medial temporal lobe structure and function, which deteriorates in AD dementia.

The first study in Chapter 3 presents longitudinal epidemiological work from a large database of individuals from the Alzheimer's Disease Neuroimaging Initiative (ADNI) who provided self-reported measures on whether they had 'hearing loss' or not. The work assesses the most commonly used metric, subjective hearing loss, in relation to the most commonly used clinically-relevant markers such as neuropsychometry in the memory domain, neuroimaging of the medial temporal lobe and fluid neurodegenerative biomarkers, all which have an established evidence base for being related to an increased AD dementia risk in the future. The work shows the importance of using the 'right' hearing test when assessing dementia risk as subjective hearing measures may not capture this link accurately.

The second study presented in Chapter 4 examines a range of hearing abilities in older adults in the North East of England, which I have recruited and developed. I have personally assessed every individual at each encounter for the AudCog study, which has around 200 participants currently. All participants underwent objective auditory measures including the PTA, tests of SiN perception and Auditory Memory (AuM) for different sound features. The latter are novel tests I developed during the course of my PhD. The results will show that, although most hearing abilities deteriorate with age, AuM over tens of seconds may be a crucial determinant of cognitive function relevant to SiN ability. Furthermore, this study shows that both age-related changes and cognitive ability are determinants of SiN ability using structural equation modelling.

Chapter 5 presents a study that examines how the aforementioned hearing metrics are altered in people who have AD dementia and medial temporal lobe damage. The study is designed to test whether AuM differentiates people without memory and thinking problems from those with AD dementia. This study involves an application of the work developed in Chapter 4 to patient cohorts and tests whether single auditory cognitive tests or a combination of them have better classification accuracy for AD dementia. A comparison is made with AuM abilities of people who have recovered from Limbic Encephalitis (LE), a patient group that has been used as a model of mild stable medial temporal lobe damage. The study shows that a combination of SiN perception ability and AuM for particular features provide a greater classification accuracy in separating groups that do not have cognitive impairment from AD and those with this condition.

The next study in Chapter 6 presents a pilot neuroimaging study that assesses morphometric measures such as regional brain volumes and cortical thickness in relation with performance in the auditory cognitive tasks from the previous two chapters. The medial temporal lobe and other 'signature' AD regions outside this region show structural changes that are predictive of AD dementia. There are also changes that take place in the brain's white matter due or associated with neurodegenerative disease that can be detected with diffusion MRI. This study shows that morphometric changes in the medial temporal lobe, AD signature regions and central auditory processing regions are associated with performance in tasks involving auditory memory whereas the quantitative metrics used to assess white matter integrity are better related to SiN performance measures.

The final study of this thesis, described in Chapter 7, focuses on the functional imaging metrics of sound memory at the individual level. It examines brain activity using functional MRI (fMRI) whilst participants are performing an adapted version of the AuM task used in the previous chapters. Using a combination of hypothesis driven univariate Region of Interest (ROI) interest analysis methods and multivariate pattern analysis techniques such as Representational Similarity Analysis (RSA), I show that activity in the hippocampus may be related to performance in a given auditory trial.

The final chapter, Chapter 8, summarises the collection of studies that are presented in this thesis and puts them in context with the various proposed theories and mechanisms that have been discussed in the broader literature. The major gaps that I feel are necessary to address to take this work further are addressed and a discussion also takes place on the most appropriate avenues for this. Directions for further analysis and research directly related to this project are also described along with further studies which may naturally follow-on from this work.

2. General Principles, Background and Methodology

2.1. Introduction

This chapter describes the general principles, background information and methodology that has been used in the studies described in the ensuing chapters. The chapter starts with a general description of the three main cohorts that form the basis of the work in the thesis. Next, the various questionnaires and auditory tasks used in the thesis are described along with the rationale for using them. Variations in any methods are described in the specific chapters that follow that include detailed study descriptions. Finally, this chapter describes Magnetic Resonance Imaging (MRI) and the specific sequences used for the neuroimaging work in general terms.

I was involved in the conception, design, planning, ethical approval, recruitment, execution and analysis of all studies that are described in this thesis as part of my MRC Clinical Research Training Fellowship. I recruited and interacted with all participants who performed in-lab experiments. All data collection for these occurred during the last 50% of the PhD period (May 2022 until July 2023) as all research activity was affected by the Covid pandemic prior to April 2022. Specifically, study approval processes were either delayed or prolonged and recruitment was delayed substantially as the participants for the in-lab study were all older adults who were at an increased risk of the adverse effects of a Covid-19 infection.

2.2. Study Cohorts

There were three main cohorts used for the studies in this thesis:

- **The Alzheimer's Disease Neuroimaging Initiative cohort (n~1500):** The Alzheimer's Disease Neuroimaging Initiative (ADNI) study cohort consists of a diverse group of participants across various stages of Alzheimer's disease, including cognitively normal older adults, individuals with mild cognitive impairment (MCI), and patients with Alzheimer's disease dementia. The longitudinal study follows participants over several years, with comprehensive assessments involving cognitive tests, neuroimaging, and biofluid sample collection. The study aims to include a representative sample, which

allows researchers to generalise findings across a broader population. By tracking disease progression and monitoring biomarker changes, the ADNI cohort contributes significantly to the understanding and development of diagnostic tools and treatments for Alzheimer's disease. The approximate distribution of participants in each group is as follows: 600 cognitively normal older adults, 600 individuals with MCI, and 300 patients with Alzheimer's disease dementia. Further details about the makeup of the individual groups and the variables used in this thesis are provided in Chapter 3.

- **The AudCog study cohort (n=180):** This cohort included people in the North East of England with and without memory and thinking problems, which I have recruited and established. There were around 150 people whose data were used to study auditory function in ageing. These participants did not have any existing neurological or psychiatric comorbidity and were recruited from local research participant databases at Newcastle University, the Join Dementia Research registry, and through word of mouth from participants that were already recruited in the study. There were 35 participants who had a medical diagnosis that affected their memory and thinking abilities, including Mild Cognitive Impairment due to AD (MCI-AD), AD dementia and Limbic Encephalitis (LE). Majority of the patients with LE in this cohort had LE due to Leucine-rich Glioma-inactivated 1 (LGI-1) encephalitis. These conditions are described in more detail below but specific patient characteristics are provided in Chapter 5.
- **The functional MRI (fMRI) cohort (n=20):** This study included healthy younger participants from central London without memory and thinking problems. Participants were recruited from the website *www.callforparticipants.com* and from advertisements via the Wellcome Centre for Human Neuroimaging monthly newsletter. Majority of the participants were undergraduate or postgraduate students from the Greater London area.

2.2.1. Definition of Mild Cognitive Impairment due to Alzheimer's Disease and Alzheimer's Disease Dementia

AD is a progressive neurological disorder and the most common form of dementia, accounting for 60-80% of cases (Jack et al., 2018). It is a degenerative condition that primarily affects the elderly, with symptoms typically appearing after the age of 65. The disease is characterised by a

gradual decline in cognitive function, with memory loss commonly being the first symptom, which eventually impacts daily life and social interactions. The exact cause of AD is not fully understood, but it is believed to involve a combination of genetic, environmental, and lifestyle factors. The pathology of AD is marked by the accumulation of abnormal protein deposits in the brain, specifically amyloid-beta ($A\beta$) plaques and NFTs composed of Tau protein. These protein deposits disrupt communication between brain cells, ultimately leading to cell death and brain shrinkage.

MCI-AD and AD dementia are two distinct stages on the spectrum of cognitive decline associated with AD. While they share common underlying pathological features, they differ in the severity and impact of cognitive symptoms. MCI can be considered an intermediate stage between cognitively normal individuals, who are asymptomatic but may have AD neuropathology in their brains, and AD dementia. Individuals with MCI experience a noticeable decline in cognitive abilities, such as poor memory, but these changes do not significantly interfere with daily functioning and independence. MCI-AD refers to cases where the cognitive decline is primarily caused by the pathological processes associated with AD. Not all individuals with MCI progress to AD dementia, and some may even remain stable or return to normal cognitive function. However, people with MCI due to AD have a higher risk of developing dementia compared to those without MCI. AD dementia is the most advanced stage of the disease, characterised by a severe decline in cognitive function that significantly interferes with daily life, social interactions, and independence.

The diagnostic process for both MCI-AD and AD dementia involves a comprehensive evaluation of an individual's medical history, cognitive function, neuroimaging and, in some cases, laboratory tests. The diagnostic criteria for MCI-AD, as proposed by the National Institute on Aging and the Alzheimer's Association (NIA-AA) include: concerns regarding a change in cognition, impairment in one or more cognitive domains, preservation of independence in functional abilities and no dementia (McKhann et al., 2011). In addition to these core criteria, the diagnosis of MCI-AD typically involves evaluating biomarkers or other evidence suggestive of the underlying AD pathology. The NIA-AA has also proposed diagnostic criteria for AD dementia, which include cognitive decline from a previous level of performance, typically involving memory impairment and at least one other cognitive domain (e.g., language, attention, executive function, visuospatial abilities), interference with daily functioning severe enough to impair the individual's ability to perform daily activities, such as managing finances, preparing

meals, or maintaining personal hygiene, a gradual onset and progression and no alternative explanations such as cerebrovascular disease, Lewy body dementia, or major psychiatric illness. The diagnosis of AD dementia may be further classified as 'probable' or 'possible' based on the presence or absence of biomarker evidence, such as A β plaques or Tau tangles, which indicate the underlying AD pathology. It is important to note that these diagnostic criteria serve as guidelines to aid clinicians in the assessment and diagnosis of MCI-AD and AD dementia. The diagnostic process may vary depending on individual circumstances, clinical judgement and available resources.

2.2.2. *Limbic Encephalitis*

LE is a rare but serious neurological disorder characterised by inflammation of the limbic system, a set of structures in the brain that play a crucial role in memory, emotion and behaviour (Gultekin et al., 2000). The medial temporal lobe is the region of the brain most classically affected. This inflammation is a result of the immune system mistakenly attacking healthy brain tissue. LE can be categorised into two main types, based on the cause of the immune response: paraneoplastic and non-paraneoplastic. Paraneoplastic LE is associated with the presence of an underlying tumour, typically a lung, ovarian or testicular cancer. The tumour produces abnormal proteins, which trigger an immune response that inadvertently targets healthy brain tissue. Common paraneoplastic antibodies found in patients with LE include anti-Hu, anti-Ma2, and anti-CV2. Non-paraneoplastic LE is not associated with a tumour and may be triggered by infections, other autoimmune conditions, or have no identifiable cause. Autoantibodies commonly found in non-paraneoplastic ALE include anti-NMDA receptors, anti-LGI1 and anti-CASPR2. Testing for antibodies against LGI-1 and CASPR2 antigens, which are part of the Voltage-Gated Potassium Channel (VGKC), has superseded testing for non-specific antibodies to the channel (van Sonderen et al., 2016). The latter may not be a true marker of disease in LE patients.

LGI-1 encephalitis is a rare form of autoimmune encephalitis that specifically targets the LGI-1 protein, which is involved in neuronal excitability and synaptic transmission (Uy et al., 2021). It is a type of non-paraneoplastic autoimmune encephalitis, meaning it is usually not associated with an underlying tumour. LGI-1 encephalitis presents with unique clinical features, making it a distinct subtype within the spectrum of autoimmune encephalitides. Patients with LGI-1

encephalitis often exhibit a combination of symptoms, which can vary in severity and duration. Some characteristic features of LGI-1 encephalitis include faciobrachial dystonic seizures (FBDS), which are brief, involuntary muscle contractions affecting the face and arm. These seizures can occur multiple times per day and typically precede other neurological symptoms, memory impairment, hyponatraemia and sleep disturbances.

The diagnosis of LGI-1 encephalitis requires a comprehensive approach, which may include identifying the presence of characteristic symptoms, such as FBDS and hyponatremia, detection of anti-LGI-1 antibodies in the blood or cerebrospinal fluid (CSF), brain MRI which shows T2-weighted or FLAIR hyperintensities in the medial temporal lobes, although normal imaging does not exclude the diagnosis (Binks et al., 2018). The primary goal of treatment in LGI-1 encephalitis is to manage the immune response and reduce inflammation. Treatment options include immunotherapy with corticosteroids, intravenous immunoglobulin (IVIG), or plasma exchange to suppress the immune response. In cases where patients do not respond to these treatments, second-line immunosuppressive agents, such as rituximab or cyclophosphamide, may be considered. Antiepileptic drugs can be used to control seizures, while medications targeting other symptoms, such as sleep disturbances and hyponatremia, can help manage the overall clinical presentation.

The prognosis for patients with LGI-1 encephalitis is generally favourable, particularly when the condition is recognised early and treated promptly. Most patients experience significant improvement or complete recovery of their neurological symptoms with immunotherapy after the encephalitic episode. However, some patients may have subtle residual cognitive or neuropsychiatric impairments that can be detected long after they have seemingly recovered from encephalitis (Butler et al., 2014).

2.3. Questionnaires

The AudCog study used two main questionnaires, one to assess cognitive function and a second to assess musical sophistication. All participants from the second cohort performed these. They were administered by Dr. Lad.

2.3.1. *Addenbrooke's Cognitive Examination (3rd edition)*

The third edition of the Addenbrooke's Cognitive Examination (ACE-III) is a widely used cognitive screening tool for AD dementia (Hsieh et al., 2013). The ACE-III is commonly used in clinical settings, research studies, and academic settings to assess cognitive impairment and track cognitive changes over time. The ACE-III consists of five cognitive domains: attention and orientation, memory, verbal fluency, language and visuospatial abilities. It includes 19 individual subtests that are grouped into these five domains. The test takes approximately 20 minutes to administer. The attention and orientation domain assesses the individual's ability to concentrate, follow instructions and stay oriented to time and place. The memory domain evaluates different aspects of memory, including immediate and delayed recall of individual words and an address. The verbal fluency domain measures the individual's ability to generate words within specific categories, such as animals or fruits, in a given time limit and with a specific letter, such as 'P'. The language domain assesses the individual's ability to name objects, repeat phrases, and understand written and spoken language. The visuospatial abilities domain evaluates the individual's ability to perceive and manipulate visual information, such as identifying shapes and copying drawings.

The ACE-III provides a total score that reflects overall cognitive performance, as well as domain-specific scores for each cognitive domain. The ACE-III has been widely validated and has demonstrated good sensitivity and specificity in detecting dementia and mild cognitive impairment (Hsieh et al., 2013). Compared to previous editions, the third edition of the ACE incorporates some improvements, including updated normative data, revised scoring criteria, and refined test materials. It has been designed to be more user-friendly and easier to administer, with clearer instructions and improved scoring guidelines. The ACE-III is available in multiple languages and has been widely used in various cultural settings to assess cognitive function in diverse populations.

2.3.2. *Goldsmiths Musical Sophistication Index*

Aspects of auditory cognition may be relevant to one's musical ability and therefore I used a measure to quantify this (Parbery-Clark et al., 2009). The Goldsmiths Musical Sophistication Index (GMSI) is a novel tool developed by researchers to assess an individual's level of musical

sophistication (Müllensiefen et al., 2014). This index measures an individual's aptitude for understanding, appreciating, and engaging with music across various dimensions, including musical training, listening habits, and emotional responses. The GMSI incorporates multiple factors to provide a comprehensive assessment of an individual's musical sophistication. It takes into account the extent of an individual's musical training, such as formal education in music theory, instrument playing, or vocal training. It also considers an individual's listening habits, including their exposure to a diverse range of musical genres, their ability to discern musical nuances, and their familiarity with different musical cultures. It also evaluates an individual's capacity to connect with music on an emotional level, such as identifying and expressing emotions evoked by music, as well as their ability to recognize and appreciate complex emotional expressions conveyed through music. The GMSI represents an advancement in the understanding of musical sophistication and its multidimensional nature. Scores on this questionnaire correlate with musical abilities such as melodic beat perception and melodic memory (Müllensiefen et al., 2014). I have also previously shown that performance on a task measuring auditory memory over seconds for frequency is associated with performance on this questionnaire (Lad et al., 2021).

2.4. Auditory Testing

2.4.1. Principles of human hearing

The human auditory system facilitates the perception of sound, enabling us to communicate, appreciate music and navigate our environment. The processing of sound begins with the outer ear, where the pinna collects and directs sound waves into the external auditory canal. These waves travel down the canal and reach the tympanic membrane or eardrum, causing it to vibrate. The vibrations from the eardrum are then transmitted to the middle ear. In the middle ear, the ossicles – malleus, incus, and stapes – act as a mechanical linkage, amplifying the vibrations and transferring them to the oval window of the inner ear. The vibrations at the oval window create pressure waves in the fluid-filled cochlea. Inside the cochlea, the pressure waves cause the basilar membrane to move, stimulating the hair cells within the organ of Corti. These hair cells, which function as mechanoreceptors, convert the mechanical vibrations into electrical signals or nerve impulses. These nerve impulses are then transmitted via the auditory nerve, also known as the cochlear nerve, to the brainstem.

Upon reaching the brainstem, the auditory nerve fibres connect with neurons in the cochlear nucleus (Cope et al., 2015). The signal then travels through several relay centres, including the superior olivary complex and the inferior colliculus. These structures play crucial roles in sound localisation and the integration of auditory information from both ears. Next, the signal reaches the medial geniculate nucleus of the thalamus, which serves as a relay station between the brainstem and the cerebral cortex. From the thalamus, the auditory signal is sent to the primary auditory cortex, located in the superior temporal gyrus of the temporal lobe.

The primary auditory cortex contains systematic representation of the time and frequency features of a sensory stimulus (Cope et al., 2015; King et al., 2018). These representations provide a mechanism for perception. Further processing occurs in adjacent regions of the auditory cortex, known as the secondary and tertiary auditory areas. These regions are involved in more complex aspects of auditory perception, such as responding to speech, music, and other environmental sounds. The primary auditory cortex, or A1, is situated in the superior temporal gyrus within Heschl's gyrus. It receives input directly from the medial geniculate nucleus (MGN) of the thalamus. A1 is organised such that neurons are arranged according to the frequency of the sound they respond to, with low frequencies at one end and high frequencies at the other. This 'tonotopic' organisation allows for the initial processing of basic sound properties such as pitch, loudness, and duration. Neurons in A1 are also sensitive to the direction and location of sound sources, enabling sound localization. Surrounding the primary auditory cortex is the secondary auditory cortex or A2, which comprises the belt and parabelt regions. The belt region is directly adjacent to A1 and receives input from both A1 and the MGN. The parabelt region is located outside the belt and receives input mainly from the belt region. The secondary auditory cortex is involved in more complex sound processing, such as identifying patterns and distinguishing between different types of sounds. A2 plays a crucial role in processing speech and language by extracting phonetic, prosodic, and semantic information from auditory input. The auditory cortex is also recognised to be involved in prediction, perceptual decision-making and learning as part of a network with other brain regions.

Beyond the secondary auditory cortex lie the tertiary auditory areas, which include the anterior and posterior superior temporal sulcus and other regions in the temporal, parietal, and frontal lobes. These connections have traditionally been divided into a 'ventral' and 'dorsal' stream of auditory processing akin to the visual brain hierarchy (Rauschecker, 2012). The 'ventral'

auditory stream has been shown to respond to 'meaning' associated with auditory stimulus and projects anteriorly in the temporal lobe, whereas the 'dorsal' pathway deals with spatial analysis and sensorimotor-integration such as conversion of auditory signals into a motor speech code (Cohen et al., 2016; Friederici, 2011). Hemispheric asymmetry also exists in the auditory system in humans with the left hemisphere (usually) being specialised for language.

2.4.2. *Pure Tone Audiometry*

Pure tone audiometry (PTA) is a widely used diagnostic test to evaluate the hearing ability of an individual. It measures the minimum hearing threshold at various frequencies to determine the type, degree, and configuration of hearing loss. In the AudCog study, PTA measurements were used to measure the degree of hearing loss only. It is usually conducted in a soundproof booth or room to ensure accurate results. During a PTA test, the individual wears headphones and is instructed to signal when they hear a tone by pressing a button or raising their hand. The tester presents pure tones at different frequencies, typically ranging from 250 Hz to 8000 Hz, at varying intensities or loudness levels, measured in decibels (dB). The tones are usually delivered through headphones. The results of pure tone audiometry are plotted on an audiogram, which is a graph that displays the individual's hearing thresholds for each frequency tested. The hearing thresholds are represented by symbols on the graph, with the vertical axis indicating the intensity in dB and the horizontal axis representing the frequency in Hz (Fig 2.1).

As individuals age, changes in the auditory system can affect the results of pure tone audiometry. Age-related hearing loss, also known as presbycusis, is a common condition that affects many older adults (Gates and Mills, 2005). The typical pattern of presbycusis is a gradual decline in hearing sensitivity, particularly in the high-frequency range, above 4000 Hz, where age-related hearing loss often first manifests. PTA results in ageing individuals may show an increase in hearing thresholds, which means that higher intensities are needed for them to perceive sounds compared to younger individuals. The degree of hearing loss can vary from mild to severe, and it may be bilateral, affecting both ears equally. Mild hearing loss is typically defined as having hearing thresholds between 25 dB to 40 dB in the better ear. Moderate hearing loss is defined as having hearing thresholds between 41 dB to 60 dB. Severe hearing loss is defined as having hearing thresholds above 60 dB.

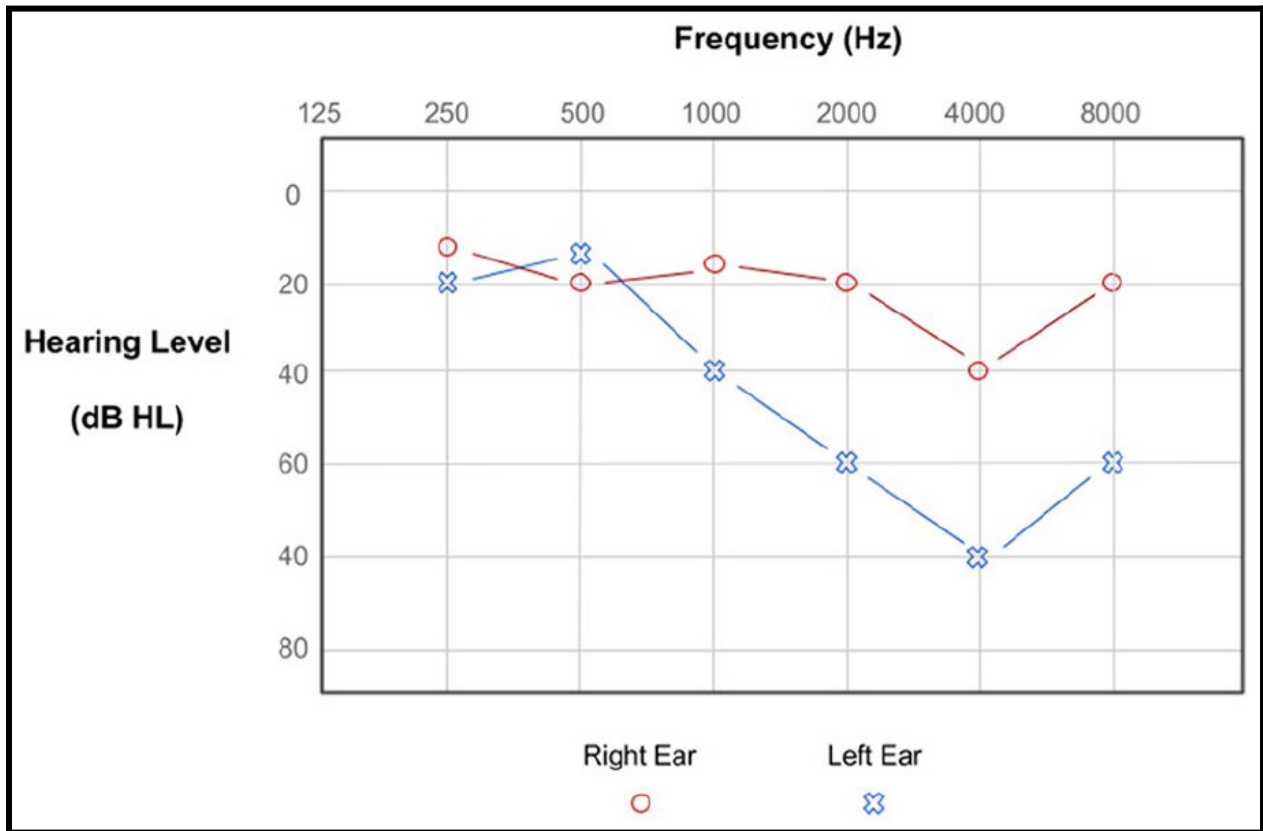

Figure 2.1. A pure tone audiogram result. The diagram shows the level of amplification in decibels (dB)(y-axis) of a pure tone at varying frequencies in hertz (Hz)(x-axis) for an individual's left ear (blue crosses) and right ear (red circle). At high frequencies, a greater level of amplification is required for the left ear (moderate hearing loss) than the right ear (mild hearing loss). This pattern of hearing loss is common with ageing.

Another change that may be observed in PTA results in ageing is a sloping configuration, where the hearing thresholds are worse at higher frequencies compared to lower frequencies. This is a characteristic pattern of age-related hearing loss, with poorer hearing in the high-frequency range, which can impact the ability to understand speech clearly, especially in noisy environments. Age-related changes in PTA results are not the only factors that can affect hearing in older individuals. Other factors, such as noise exposure, medical conditions, medications and genetic factors, can also contribute to changes in hearing ability. The PTA provides an accurate assessment of low-threshold auditory nerve fibres in an individual but is unlike real-life given the testing at single frequencies at very low level.

2.4.3. *Speech-in-Noise Hearing Tests*

Speech perception is a fundamental aspect of human communication, enabling us to understand and interact with others in various environments. However, speech perception can be challenging, particularly in noisy environments where background noise can interfere with the clarity and intelligibility of speech. Despite the ability of the human auditory system to process speech in adverse listening conditions, this ability can decline with age. Presbycusis results in a decline in hearing sensitivity, particularly in the higher frequency range where important speech cues exist. However, age-related changes in speech perception in noise is not solely attributed to hearing sensitivity loss but involves complex interactions between sensory, cognitive, and neural factors. Understanding the underlying mechanisms of speech in noise hearing and how it changes with ageing is crucial for developing effective interventions and improving the quality of life for older individuals who struggle with communication in noisy environments but also if these changes have relevance for the diagnosis of medical conditions such as dementia.

The Digits in Noise (DiN) test is a widely used and well-established speech perception test that assesses an individual's ability to understand spoken digits in the presence of background noise. It is a valuable tool for evaluating speech perception in noisy environments, which is a common real-world listening scenario. The DiN test typically involves presenting a series of spoken digits (e.g. 0-9) in varying levels of background noise to the listener (Figure 2.2). The digits are typically spoken by a standardised talker and are presented at a fixed level, while the background noise level is adjusted to different signal-to-noise ratios (SNRs), representing the ratio between the level of the speech signal and the level of the background noise. The listener's task is to accurately repeat the digits they hear and their performance is typically scored based

on the SNR at which they may be able to successfully identify the three numbers with a chosen probability threshold. Various methods can be used to establish this. Despite its widespread use and utility, the DiN test is not without limitations. Factors such as test materials, talker variability, and the specific SNR used can impact test results. Additionally, the DiN test primarily focuses on the perception of isolated digits, which may not fully represent the complexities of speech perception in real-world communication.

Adaptations of the traditional DiN test have been developed which may provide a better assessment of the central auditory pathways. The Dichotic DiN test has different auditory stimuli presented simultaneously to both ears, with the goal of evaluating how the brain processes and integrates information from both ears. This may be particularly challenging in listening conditions such as in the presence of background noise. The way different information is presented in each ear can vary ranging from presenting the digits in one ear and the background noise in the other to more sophisticated methods such as presenting the same content in both ears but changing properties of the auditory signal (such as phase-shifting) in one of the ears (De Sousa et al., 2020). Dichotic DiN tests can provide insights into the functional integrity of the auditory processing pathways and the central auditory system, including the ability to process auditory information from both ears simultaneously. Performance on these tests has also been related to cognitive impairment due to AD (Utoomprurkporn et al., 2020). One limitation of this test may be that results could potentially be influenced by factors such as ear preference and attentional strategies.

People usually communicate in sentences, rather than digits and there are tests that have been developed in the scientific literature that potentially have more ecological validity than the DiN test. The QuickSiN assesses the ability to identify sentences presented on a background of people talking. Here, the auditory level of the sentence is varied against a varying background of multi-talker babble (Killion et al., 2004). This simulates an environment that one might encounter in real life. Our laboratory has previously developed an adapted version of this test based on the Oldenburg matrix sentence structure of name, verb, numeral, adjective and noun (Figure 2.3) (Holmes and Griffiths, 2019). The test has been shown to be associated with individual auditory memory performance for various sound features (Lad et al., 2020). Therefore, one of the aims of this thesis was to assess whether performance on this task is associated with cognitive impairment with AD dementia or other forms of medial temporal lobe damage such as LE.

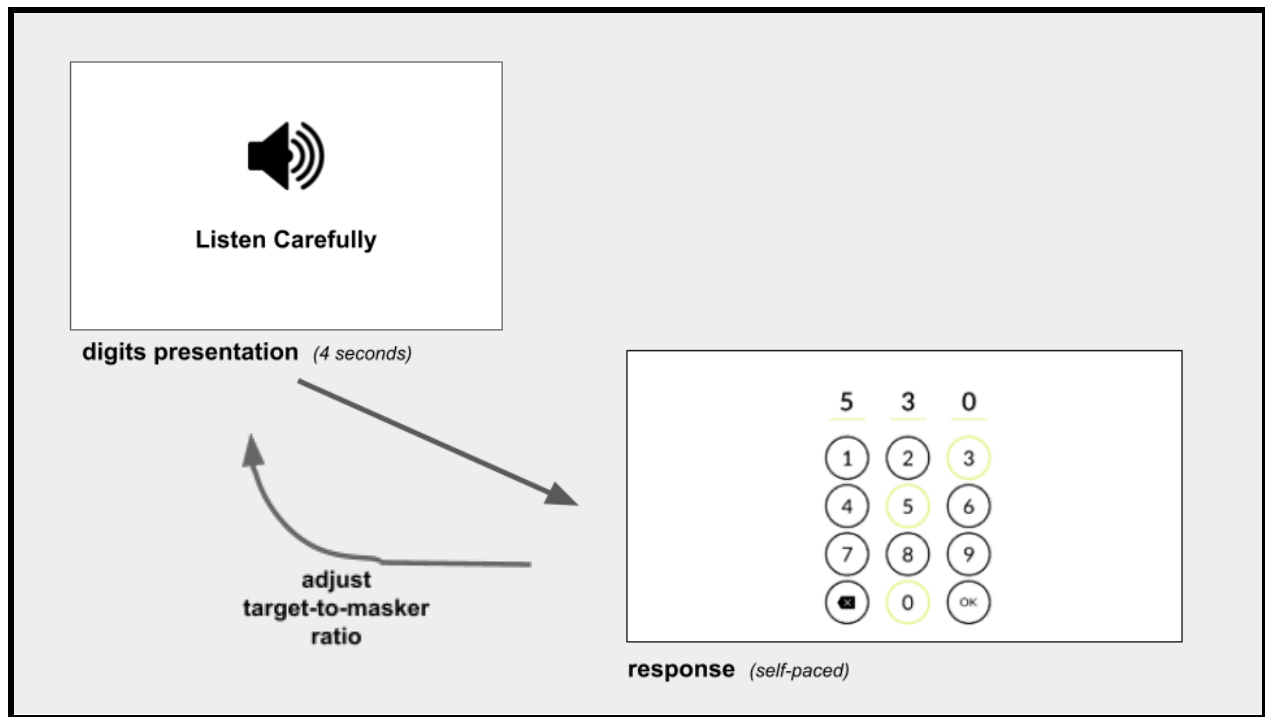

Figure 2.2. *The Digits-in-Noise Task.* The diagram shows a trial of the digits-in-noise task as experienced by a participant. A trial starts with three digits being presented on a background of white noise for 4 seconds (3 seconds plus 1 second delay). Further detail is provided in Chapter 4. Then a screen displays the options for those digits by displaying a keypad on the screen. Participants have to choose three numbers, in the correct order, and guess when they are unsure. This response phase is self-paced. After they accept their choice, the trial ends and the target-to-masker ratio (the loudness of the digits compared to the background noise) is adjusted. If the response is correct (all five choices are correct) then the ratio decreases and vice-versa. The experiment ends when the stopping criteria described in Chapter 4 is met.

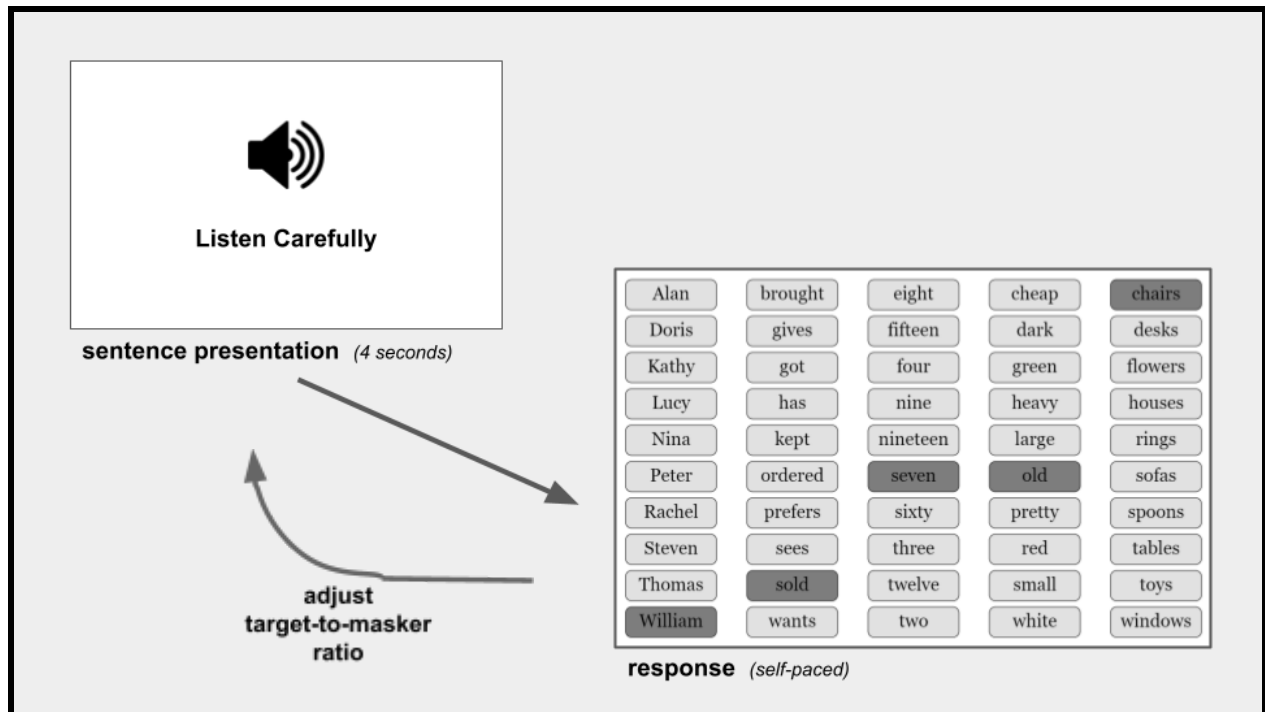

Figure 2.3. *The Speech-in-Babble Task.* The diagram shows a trial of the speech-in-babble task as experienced by a participant. A trial starts with a sentence being presented on a background of 16-talker babble for 4 seconds (3 seconds plus 1 second delay). Further detail is provided in Chapter 4. Then a screen displays the options for that sentence. There are five columns and each column corresponds to the position of the word in the sentence i.e. the first word will be in the first column and the third word will be from the third column. Participants have to make a choice from each column and guess when they are unsure. This response phase is self-paced. After they accept their choice, the trial ends and the target-to-masker ratio (the loudness of the sentence compared to the background babble) is adjusted. If the response is correct (all five words are correct) then the ratio decreases and vice-versa. The experiment ends when the stopping criteria (using ‘reversals’) described in Chapter 4 is met.

2.4.4. *Short-term Auditory Memory*

Short-term auditory memory (AuM) refers to the cognitive system responsible for temporarily storing and manipulating auditory information over seconds. If the level of manipulation of the auditory information present in a given task is high, this ability has also been labelled as auditory working memory in the scientific literature. AuM allows individuals to retain and process sounds, speech, and other auditory stimuli for a short period of time. This system is essential for various cognitive tasks, such as language comprehension, learning, problem-solving and can also provide a window into long-term memory processes traditionally associated with episodic memory (Yonelinas, 2013).

The psychological literature presents two models that purport to explain the nature of working memory: discrete, 'slot-based' models and continuous, resource allocation based models (Ma et al., 2014). Discrete models propose that working memory has a fixed number of 'slots,' which represent the maximum number of items that can be stored at a given time. Each slot can hold one item, and when all slots are occupied, no additional information can be stored. According to this view, working memory capacity is limited by the number of available slots, and the quality of the stored information does not degrade as more slots are filled. This model is analogous to a set of boxes, where each box can hold one item, and when all the boxes are filled, no more items can be added. Continuous, resource allocation based models, on the other hand, suggest that working memory is a flexible system with a limited pool of resources that can be allocated to store and manipulate information. Instead of having a fixed number of slots, the capacity of working memory is determined by the amount of available resources, which can be distributed across different items. In this view, the quality of stored information can degrade as more resources are allocated to additional items, leading to a trade-off between the number and quality of items in working memory. This model is more akin to a fluid system, where the resources can be allocated in varying amounts to different items, depending on the task demands and cognitive load.

AuM can provide a window into long-term memory processes as tasks for this cognitive ability may involve overlapping neuroanatomical structures despite traditionally being associated with separate brain systems. Studies have suggested that long-term memory is preferentially supported by medial temporal lobe structures whereas working memory by networks between

prefrontal, parietal and sensory cortices (D'Esposito and Postle, 2015; Linden, 2007; Shrager et al., 2008). Evidence from vision suggests that brain structures involved in long-term memory processes can be activated by short-term memory tasks that require high-resolution memory or the binding of multiple visual features or that performance in these tasks can be affected by damage to them (Borders et al., 2022; Yonelinas, 2013; Zokaei et al., 2019). Using tasks that are best suited to resource allocation model descriptions, the results indicate that people who have hippocampal lesions have a poor resource to bind multiple features of a visual object. Such findings have also been shown in people who have been diagnosed with AD dementia (Zokaei and Husain, 2019). Data with auditory tasks lacking and further work is necessary to establish whether the binding of auditory features may be supported by these brain regions as well.

Another theoretical framework that links short-term and long-term memory processes is that of Long-term working memory, a model proposed by Ericsson and Kintsch in 1995 to explain the role of long-term memory in supporting working memory performance, particularly in expert performers (Ericsson and Kintsch, 1995). According to this theory, experts develop specialised knowledge structures in their long-term memory, called retrieval structures, that enable them to efficiently store and access task-relevant information. These retrieval structures facilitate the integration of information from working memory and long-term memory, allowing experts to maintain and manipulate large amounts of information in their working memory than would otherwise be possible. There is evidence of structural changes in medial temporal structures of 'experts' such as London taxi drivers and piano tuners (Kumar et al., 2014; Teki et al., 2012). An open question remains in the auditory domain as to whether auditory expertise for auditory features is also associated with structural and functional changes in the medial temporal lobe. Here, AuM seems like an ideal candidate to assess this proposition.

I designed an AuM task based on the resource allocation model which can provide a window into long-term memory processes. This is shown in figure 2.4. In a trial, participants were asked to keep an auditory stimulus in mind and 'find' the stimulus on a fixed horizontal scale that they could interact with after a delay. The stimulus can either be a pure tone, parameterised by frequency, or amplitude modulated (AM) white noise that is parameterised by the AM rate. A black cross at the centre of the screen with a white background marked the start of a trial. The initial stimulus was played for 1 sec. After a delay of 2 to 4 seconds (randomly generated from a uniform distribution between these values), participants viewed a 800 px horizontal line with a

mouse-movable marker. To mark the beginning of the 'Matching' phase, a written instruction, "Listen Carefully", was provided after which the horizontal line appeared. Participants could freely move the marker and click to generate the stimulus at *the clicked* location for 1 sec. When they were satisfied that their click matched the original stimulus of interest, they could press the Return key on a keyboard. The parameter space for the stimulus of interest was mapped linearly to the pixel location of the horizontal scale. The extremes (10% most leftward and 10% most rightward) of the scale were not used for mapping as pilot studies indicated that performance is non-Gaussian and skewed when stimuli are matched at these boundaries. Further details regarding the exact number of trials used for the AudCog in-person study in Newcastle and that used for the adapted task in London for the fMRI study are described in their respective chapters.

Each trial produces a metric called an error that is the difference in parameter of the matched sound to the parameter of the probed sound. Over the course of the experiment, these errors can be accurately modelled by a Gaussian distribution with a mean centred on zero. The standard deviation allows us to then measure the resource allocated to the sounds played to an individual. A lower standard deviation indicates a better resource for the auditory stimulus whereas a larger one indicates poor performance and a reduced resource. Studies using this methodology have often used the inverse of the standard deviation, termed the precision, to refer to performance where a lower standard deviation translates into a higher precision and, intuitively, a better performance (Ma et al., 2014). Auditory precision is used as the output metric used for individual and group-level comparisons in the following chapters.

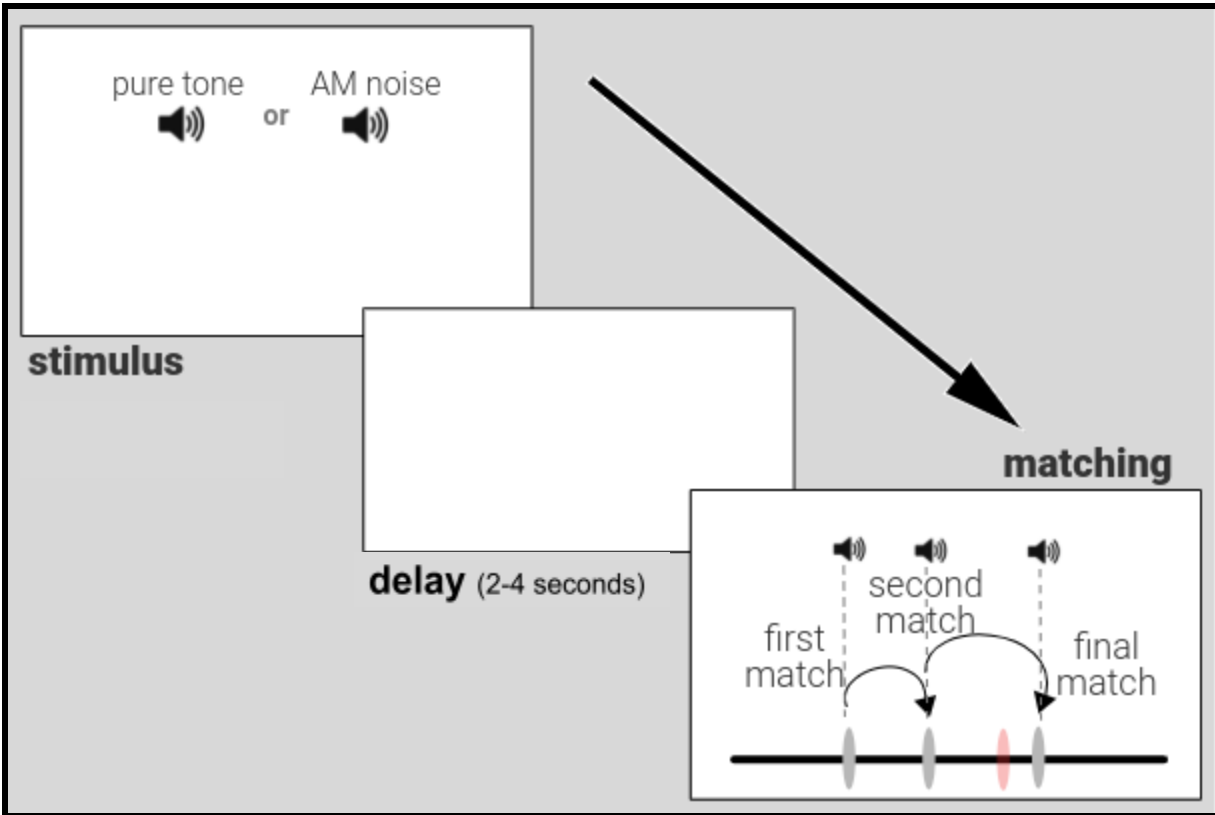

Figure 2.4 Auditory Memory Precision Experiment. An auditory (pure tone or amplitude modulated noise) or a visual (colour or flashing box) stimulus is presented for 1 second, then, after a delay of 2 to 4 seconds, participants can match sounds using a horizontal scale on the screen. The scale is linked to the parameter of interest (frequency for pure tone or AM rate) that can generate the original stimulus after exploring the parameter space to 'find' the stimulus. The figure shows an auditory matching trial where the participant's 'final match' (rightmost dark grey marker on the scale) is shown in comparison to where the original stimulus (orange marker on the scale) is actually located. In this example, the participant first clicked on the scale to make a 'first match' (which produced a sound linked to the parameter at that location), then a 'second match' and then a 'final match'. The discrepancy between the 'final match' location parameter and that of the original stimulus gives an 'error' for each trial that can be used to calculate the auditory working memory 'precision', the inverse of the standard deviation of errors from a trial target, for all auditory trials.

2.5. MR Neuroimaging

2.5.1. *Structural Magnetic Resonance Imaging*

Structural magnetic resonance imaging (MRI) is a powerful neuroimaging technique that allows researchers and clinicians to visualise the structural details of the human brain with precision. MRI uses strong magnetic fields and radio waves to generate detailed images of the brain's anatomy, providing insights into its structure and organisation. Neuroimaging has transformed the field of dementia as it has allowed clinicians to rule mimics out and identify atrophy patterns in the brain that can support a diagnosis of dementia.

MRI typically involves two common types of weighted images: T1-weighted and T2-weighted images. T1-weighted MRI is based on the principle of longitudinal relaxation time (T1), which is the time it takes for the protons in a tissue to recover their equilibrium after being excited by a radiofrequency pulse. In T1-weighted images, brain tissues with short T1 relaxation times, such as white matter, appear bright, while tissues with long T1 relaxation times, such as grey matter, appear dark. T1-weighted images are useful for visualising the overall brain anatomy, as they provide excellent contrast between grey and white matter, making it easier to identify structures like the cortex, basal ganglia, and ventricles. T2-weighted MRI is based on the principle of transverse relaxation time (T2), which is the time it takes for the protons in a tissue to lose their coherence and return to their original alignment after being excited. In T2-weighted images, brain tissues with short T2 relaxation times, such as grey matter, appear bright, while tissues with long T2 relaxation times, such as white matter, appear dark. T2-weighted images are sensitive to changes in tissue water content, making them useful for identifying abnormalities such as oedema, inflammation, and lesions.

Both T1-weighted and T2-weighted images are essential in clinical practice and research, as they provide complementary information about the structural characteristics of brain tissues. Longitudinal studies using T1-weighted and T2-weighted MRI have shown that certain brain regions, such as the hippocampus and entorhinal cortex, exhibit progressive atrophy in individuals with AD. In the field of research these changes can also be quantified using advanced image analysis techniques, such as voxel-based morphometry and cortical thickness analysis, which allow for the detection of subtle changes in brain structure that may precede the onset of clinical symptoms. Automated software pipelines now allow quick and accurate

analysis of various regions of interests in the brain at no cost (Fischl et al., 2004). A combination of such methods are used for brain imaging analysis in this thesis and described in greater detail in Chapters 6 and 7.

2.5.2. *Diffusion Magnetic Resonance Imaging*

Diffusion MRI (dMRI) is a powerful neuroimaging technique that provides insights into the structural characteristics of brain tissues by measuring the diffusion of water molecules. dMRI is particularly sensitive to the movement of water molecules within tissues, which can reveal information about the structural integrity and organisation of neural pathways in the brain such as its white matter.

The principle behind dMRI is based on the Brownian motion of water molecules, which is the random movement of particles in a fluid due to thermal energy. In brain tissues, water molecules diffuse along the direction of the neural fibres, as they encounter barriers such as cell membranes, myelin sheaths, and other cellular structures. The extent and directionality of water diffusion are influenced by the microstructural characteristics of the tissue, such as cell density, axonal orientation, and tissue integrity. dMRI utilises a specific type of MRI pulse sequence called a diffusion-weighted imaging (DWI) sequence. In DWI, a pair of strong magnetic gradients is applied before and after a radiofrequency pulse, sensitising the MRI signal to the diffusion of water molecules. By acquiring multiple DWI images with different gradient strengths and directions, a diffusion tensor can be calculated, which describes the magnitude and direction of water diffusion in each voxel of the brain. In such a way, the various tracts of the brain can be pieced together, voxel by voxel.

One of the commonly used measures derived from diffusion MRI is the fractional anisotropy (FA), which quantifies the directionality of water diffusion. FA values range from 0 to 1, with higher values indicating greater directionality of diffusion, suggestive of well-organised neural pathways. Another measure is the apparent diffusion coefficient (ADC), which quantifies the magnitude of water diffusion. Changes in FA and ADC values can provide information about alterations in tissue microstructure, such as axonal damage, demyelination, or changes in cellularity. In people who are at different stages of AD, changes in these values have been noted in the temporal lobes and specific tracts involving the limbic system (Damoiseaux et al.,

2009; Douaud et al., 2011). dMRI analysis has advanced tremendously over the past decade and these methods as well as advances in image acquisition such as multi-shell imaging have resulted in more detail being available about the tracts of the brain in health and disease. These methods have been relatively underexplored in AD (Acosta-Cabronero and Nestor, 2014; Chua et al., 2008).

2.5.3. *Functional Magnetic Resonance Imaging*

Functional magnetic resonance imaging (fMRI) is a powerful neuroimaging technique that allows for the visualisation and mapping of brain activity in real-time. fMRI measures changes in blood oxygenation and flow in response to neural activity, providing insights into the functional organisation of the brain. The principle behind fMRI is based on the fact that when a region of the brain becomes active, it requires more oxygenated blood to meet its increased metabolic demands. This results in an increase in blood flow to that region, known as the hemodynamic response. The hemodynamic response is coupled with changes in blood oxygenation level-dependent (BOLD) signals, which can be detected using MRI. This BOLD signal is said to reflect neuronal activity in the various 'activated' regions of the brain; however its fundamental relationship with neuronal computation has not been clearly mapped out (Kullmann, 2020). A pervasive model suggests that BOLD signal reflects local field potential activity of neurons in a region of the brain rather than the spiking rate of individual neurons (Ekstrom, 2010).

fMRI typically involves the acquisition of a series of images over time, while a participant performs a task or is at rest. These images are then analysed to identify regions of the brain that show changes in BOLD signal intensity, which correspond to areas of increased neural activity. The changes in BOLD signal intensity are typically represented as activation maps, which display the spatial distribution of brain activity in response to a specific task or condition. One of the most widely used methods in fMRI is called the task-based or event-related fMRI. In this approach, participants perform a specific task or undergo a sensory or cognitive stimulation while inside the MRI scanner. Changes in BOLD signals associated with the task or stimulation are then analysed to identify brain regions that are functionally engaged during the task. In Chapter 7, I use an event-related design to study BOLD patterns in the brain that may be informative about memory performance on a trial by trial basis. The exact methodology and the imaging parameters used are also described in further detail.

3. Subjective Hearing Loss and Risk of Dementia

3.1. Introduction

Hearing loss in midlife (between the ages of 45 and 60) is associated with an increased risk of dementia in the future (Deal et al., 2017; Lin et al., 2011a; Loughrey et al., 2018). Studies that have provided this evidence have usually used the PTA, a test which objectively measures minimum intensity perceived by an individual for a range of tones, at different frequencies, from 250 Hz to 8kHz, in silence. These studies have found a dose-dependent effect with severe hearing loss having the greatest risk of dementia compared moderate hearing loss, mild hearing loss and no hearing difficulty. However, these studies have not included other forms of hearing that may have associations with hearing-in-quiet, which is measured by the PTA, such as SiN perception. This form of hearing has also been associated with dementia risk (Stevenson et al., 2022; Tuwaig et al., 2017). People with severe speech-in-noise (SiN) perception ability are also at greater risk of dementia than people with mild impairments and those with no impairments.

Prior work has suggested that objective hearing measures are specifically linked to risk of AD dementia, potentially through a neurobiological process. The hearing loss could therefore be an indicator of the AD disease process itself. Poor hearing on the PTA is associated with faster rates of medial temporal lobe atrophy over time, a brain region that is affected early with neuropathology in AD (Lin et al., 2014). Poor SiN hearing metrics are also linked cross-sectionally to higher cerebrospinal fluid (CSF) phosphorylated-Tau-181 (pTau-181) levels, a sensitive biochemical marker that predicts conversion to AD dementia (Tuwaig et al., 2017). pTau-181 levels capture abnormal Tau accumulation in response to amyloid pathology (Barthélemy et al., 2019). This finding contrasts with amyloid status where there is no association between PTA measures and amyloid levels in the brain, cross-sectionally (Parker et al., 2019). However, Tau status better reflects cognitive impairment in people at risk of AD dementia and this has not been studied in association with hearing status in detail (Bejanin et al., 2017).

Although objective hearing measures provide robust and reliable values for an individual, there are disadvantages to using these tests, which may be overcome by using subjective measures. Objective tests are more time-consuming than subjective tests and require specialist equipment

and training. They may not accurately reflect an individual's everyday listening experience, as the hearing tests are typically performed under controlled laboratory conditions. Real-world listening environments can be much more complex and dynamic than those encountered in a soundproof booth, making it challenging to accurately assess an individual's hearing abilities. Subjective hearing loss is easier to measure and has been associated with objective hearing loss by PTA thresholds (Nondahl et al., 1998). A single question about hearing loss, "Do you feel you have hearing loss?" has greater than 90% sensitivity for PTA defined moderate to severe hearing loss in some work (Sindhusake et al., 2001). If a dose-dependent relationship between hearing loss and dementia risk exists, then it could be argued that subjective hearing loss could identify people with the greatest risk of future dementia. Some studies that have used subjective measures of hearing loss by direct questioning have also elicited a dementia risk. One study found poor subjective hearing is linked to poor episodic memory in the form of immediate and delayed recall for word lists (Maharani et al., 2019). Clinician-judged hearing impairment has also been linked with more severe AD pathology in cognitively normal individuals and with a greater burden of vascular and Lewy body pathology post-mortem (Brenowitz et al., 2020). Therefore, it is reasonable that subjective hearing loss may also capture the relationship between hearing loss and dementia via the same mechanisms as objective measures.

There have been mixed findings of associations between subjective hearing loss and AD dementia. Self-reported hearing impairment has been associated with an increased risk of MCI, a known precursor to dementia (Buchholz et al., 2022). Subjective hearing difficulties during non-auditory clinical assessments have also been associated with an increased rate of developing dementia and cognitive decline (Gurgel et al., 2014). However, another study found no change in any known neurodegenerative disease in post-mortem brain samples of those with and without subjective hearing loss (Neff et al., 2019). Further work is necessary to understand the factors that underlie these findings such as whether subjective hearing loss predicts clinical markers of dementia *in-vivo* as post-mortem studies may not adequately capture an temporal relationship between the time hearing loss was measured and the onset of dementia.

In this study, I sought to test whether subjective hearing loss increases the risk of AD dementia by considering neuropsychological, neuroimaging and biochemical markers that are specifically linked to AD dementia diagnosis or its risk in the future (Grober et al., 2000; Mielke et al., 2022; Whitwell et al., 2012). I examined whether stable cognitively normal and MCI individuals with

subjective hearing loss had greater changes in episodic memory scores, hippocampal volumes, and pTau-181 CSF levels over time in the ADNI cohort. The benefit of studying this population is twofold: 1) there are a larger number of participants whose clinical diagnosis stays unchanged over a 5-year period and this gives more power to identify meaningful changes in biomarkers, 2) some individuals may develop AD dementia over much larger time scales and the first indication of an increased risk of dementia may be a deviation from a healthy population by showing faster changes in cognitive, neuroimaging or fluid biomarker metrics.

Furthermore, I also studied these variables in those participants with MCI who converted to AD dementia over a 5-year period to study if hearing loss was associated with faster episodic memory decline, hippocampal volume loss, changes in phosphorylated Tau CSF levels. This would support subjective hearing loss as a metric to predict the onset of dementia. I also assessed whether hearing loss was associated with a greater risk of conversion to AD dementia using survival analysis. Studying this population is crucial as it provides a direct evaluation of people in the preclinical stages of dementia. Therefore, any increase in risk for dementia due to subjective hearing status can be directly attributed to this variable.

3.2. Methods

3.2.1. The Alzheimer's Disease Neuroimaging Initiative

ADNI is an extensive, longitudinal, multicentre study that aims to identify, develop, and validate biomarkers for the early detection, diagnosis, and monitoring of AD (Weiner et al., 2017). Initiated in 2004 and funded by both public and private organisations, ADNI has been a collaborative effort among researchers, clinicians, and patients from various institutions across the United States and Canada. ADNI's primary objective is to establish correlations between clinical, cognitive, imaging, and biofluid markers throughout the progression of Alzheimer's disease. The study focuses on three stages of the disease: preclinical AD, MCI, and AD dementia. Participants are monitored and assessed through comprehensive protocols, which include cognitive testing, MRI, positron emission tomography (PET), and collection of biofluid samples such as CSF and blood. In addition to its primary focus on imaging and biofluid biomarkers, the ADNI study also collects data on participants' self-reported hearing loss. This

information provides researchers with an opportunity to investigate the potential link between hearing loss and the risk of dementia.

Data collected from ADNI has significantly contributed to our understanding of Alzheimer's disease and has led to numerous scientific discoveries. The study has elucidated the role of biomarkers like A β and Tau proteins in disease progression and has been instrumental in the development of novel imaging techniques, including amyloid PET and Tau PET scans. Furthermore, the ADNI dataset has facilitated advancements in computational analysis, allowing for more accurate diagnosis and prediction of disease progression. By analysing the comprehensive data collected from ADNI participants, researchers can examine the relationship between hearing loss and cognitive decline more closely, accounting for various confounding factors. This analysis may help to identify potential mechanisms underlying the association between hearing loss and dementia risk, as well as to determine whether interventions aimed at improving hearing function could be beneficial in reducing the risk or delaying the onset of dementia.

3.2.2. *Participants*

The ADNI database (<http://adni.loni.usc.edu>) has coded participant data that can be accessed for analysis with prior authorisation. As this study examined hearing loss as a predictor of AD dementia, only data from people without a diagnosis of AD at baseline was used for analysis. Therefore, people who were cognitively normal (including participants with subjective memory complaints), and MCI were included in the study. Their data from 12-, 24-, 36-, 48- and 60-month follow-ups were used for analyses. Participants with MCI who converted to a diagnosis of AD dementia at 12, 24, 36, 48 and 60 months became part of a group that were analysed separately to assess the predictive value of subjective hearing loss for subsequent dementia. These are depicted in flowcharts in figures 3.1 and 3.2. When AD dementia developed in the follow-up period, it was defined in the study as per the NIA-AA consensus criteria most commonly used in clinical practice (McKhann et al., 2011). Further details about the inclusion criteria for the study can be found on the ADNI webpage (<http://adni-info.org>).

People with subjective hearing impairment were identified by using two methods. The first was through the baseline physical examination in which participants declared if they had hearing loss (of any severity) or not. As objective data on hearing measurements was not available, all degrees of hearing loss (mild, moderate and severe) were combined into one variable that indicated whether hearing loss was present or absent. The second method included the examination of 'free-text' records including a participant's past medical history, active problems or miscellaneous information. Both these methods have been used in a similar way previously to identify people with hearing loss in the ADNI dataset (Xu et al., 2019). Although there is a substantial overlap in the participants identified by each method, a combination of these increases the yield by around 20%. A single variable that coded whether a participant had reported hearing loss or not was the end result. Due to the paucity of reliable and objective data on hearing aids and their usage, this metric was not used for further analysis in this study.

3.2.3. *Neuropsychological Assessment*

The Rey Auditory Verbal Learning Test (RAVLT) is a widely used neuropsychological test that assesses various aspects of memory, including immediate recall, delayed recall, and recognition. The first two measures were combined and used as a total composite score for further analysis in this study. Immediate recall is the first component of the test and involves the participant's ability to immediately recall a list of 15 unrelated words that are presented orally by the examiner (Tierney et al., 1994)). The procedure for immediate recall component of the RAVLT involves the following steps: the examiner reads a list of 15 unrelated words, the examiner immediately asks the participant to recall as many words as they can remember, The examiner repeats the same list of 15 words a total of five times, with the participant being asked to recall the words after each presentation and After the fifth presentation, the examiner asks the participant to recall as many words as they can remember from any of the five presentations.

The Mini-Mental State Examination (MMSE) is a widely used screening tool for assessing cognitive impairment and dementia. It is a brief, standardised test that assesses various cognitive domains, including orientation, memory, attention, language, and visuospatial skills. The test consists of 30 questions and takes approximately 10 minutes to complete. It is scored out of a maximum of 30 points, with a score of 24 or higher indicating normal cognitive

functioning. The MMSE is a useful tool for identifying cognitive impairment and monitoring changes in cognitive status over time, and was used as a global measure of cognition.

A participant had measurements for the RAVLT and MMSE test at each time point. The change in RAVLT and MMSE scores, but not absolute values, at each time point was used as the variable of interest for further analysis.

3.2.4. Neuroimaging Assessment

Cortical reconstruction and volumetric segmentation of MRI scans from the ADNI dataset were performed with the FreeSurfer 6.0 image analysis pipeline, which is a widely-used tool for automatic brain imaging analysis. It is designed to identify and label various cortical and subcortical structures, such as the grey matter, white matter, cerebrospinal fluid, and different gyri and sulci of the brain. FreeSurfer utilises advanced image processing algorithms, including intensity normalisation, tissue classification and surface deformation, to generate accurate and reliable 3D models of the brain. For the ADNI study, volumes of various Regions of Interest (ROI) used in this study were available in a tabulated format from the study website after being processed from each study site. Whole brain and hippocampal volumes for both cerebral hemispheres were combined and normalised by a participant's total intracranial volume to produce a metric each for whole brain volume and hippocampal volume. These values were used for further analysis. Changes in these values over time for an individual were used for further analysis.

3.2.5. Biochemical Assessment

A subgroup of ADNI participants underwent a lumbar puncture to obtain CSF samples for biomarker analysis. This is shown in figures 3.1, 3.2 and 3.3. pTau-181 levels were analysed at the University of Pennsylvania using the Roche Elecsys in vitro diagnostic immunoassay intended for quantitative determination of protein levels in pg/mL. Previous work has identified that a pTau-181 value of above 38.2 pg/mL has a high sensitivity and sensitivity for predicting conversion to AD dementia from MCI (Palmqvist et al., 2021). This limit was used to determine pTau positivity in an individual.

3.2.6. *Statistical Analysis*

Group-wise comparisons for neuropsychological, neuroimaging and biochemical metrics, at each time point, were conducted using an Analysis of Covariance (ANCOVA) after including Age, Sex, APOE4 status and Years of Education as covariates. All analyses were conducted in Python 3.9 using the SciPy and Pingouin libraries in Jupyter notebooks.

Survival analysis was conducted using a Cox Proportional Hazards (CPH) model to evaluate the impact of hearing loss on the risk of dementia conversion while adjusting for potential confounders. The model controlled for age, gender, years of education, and APOE4 genotype. The time-to-event outcome was defined as the time (in months) from baseline to dementia conversion or the last available follow-up, whichever occurred first. Survival curves adjusted for the aforementioned covariates were generated for individuals with and without hearing loss. All analyses were conducted using the lifelines package in Python. A significance level of $p < 0.05$ was used for all statistical tests.

3.3. **Results**

3.3.1. *Baseline Characteristics*

There were 2420 participants in the ADNI study in total with a mean age of 73 and a standard deviation of 7 years of age at baseline. 411 participants with a diagnosis of AD dementia were excluded as this study assessed the predictive value of subjective hearing loss for alterations in neuropsychological, neuroimaging or biochemical markers relevant to AD dementia risk. This left 1818 participants in total. Further details regarding baseline characteristics are shown in Table 3.1.

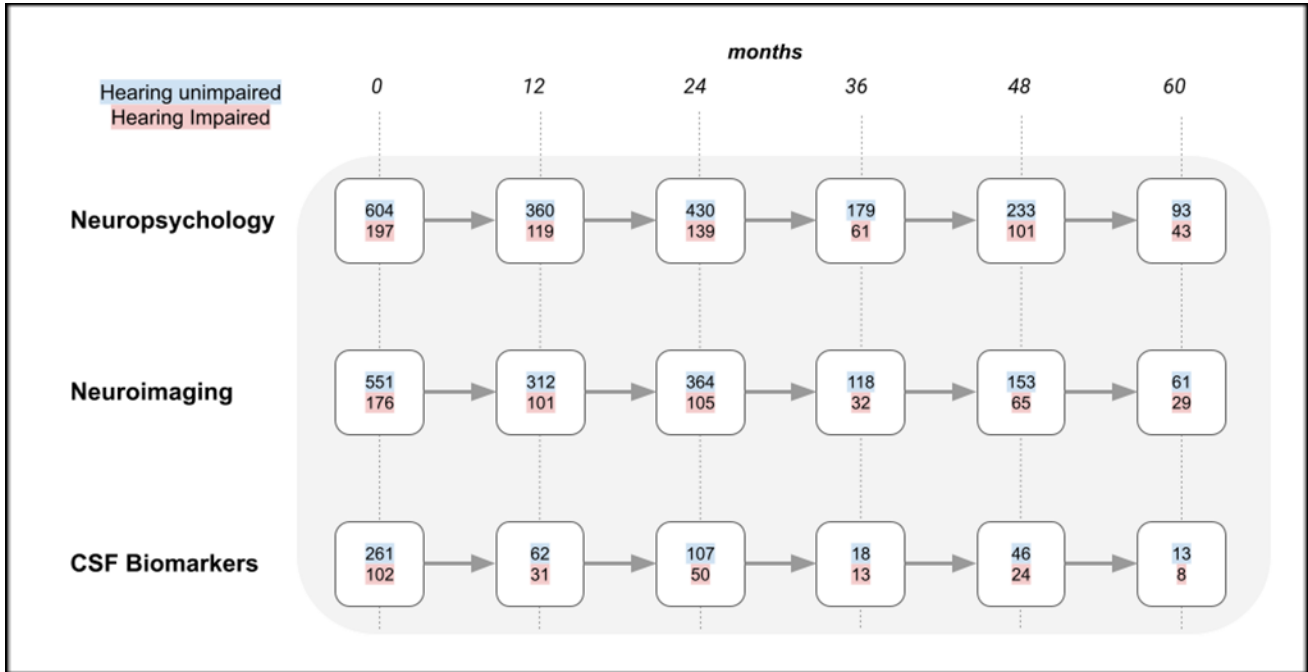

Fig 3.1. A flowchart showing the number of cognitively normal participants that remained with that diagnosis at 12-month intervals. The different rows indicate the total number of participants that completed neuropsychological, neuroimaging or CSF biomarker evaluation. The number of hearing unimpaired participants are indicated with a blue background and those with self-reported hearing impairment have a red background.

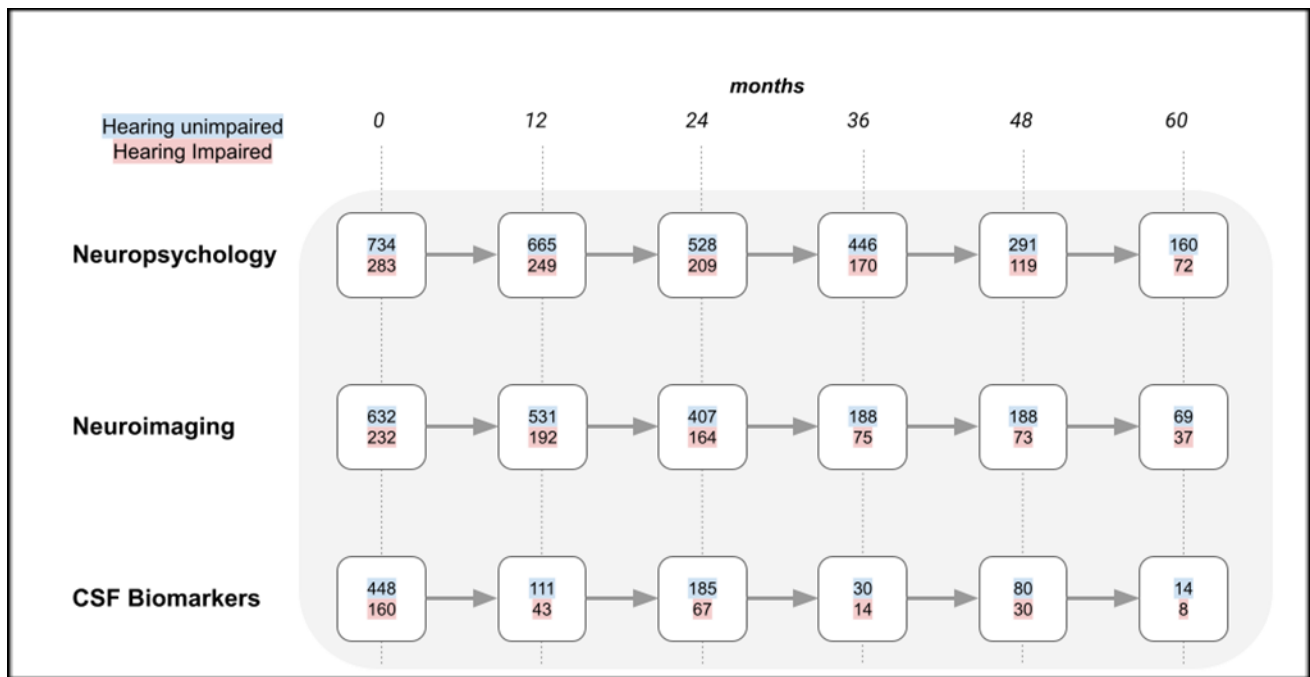

Fig 3.2. A flowchart showing the number of participants with MCI remained with that diagnosis at 12-month intervals. The different rows indicate the total number of participants that completed neuropsychological, neuroimaging or CSF biomarker evaluation. The number of hearing unimpaired participants are indicated with a blue background and those with self-reported hearing impairment have a red background.

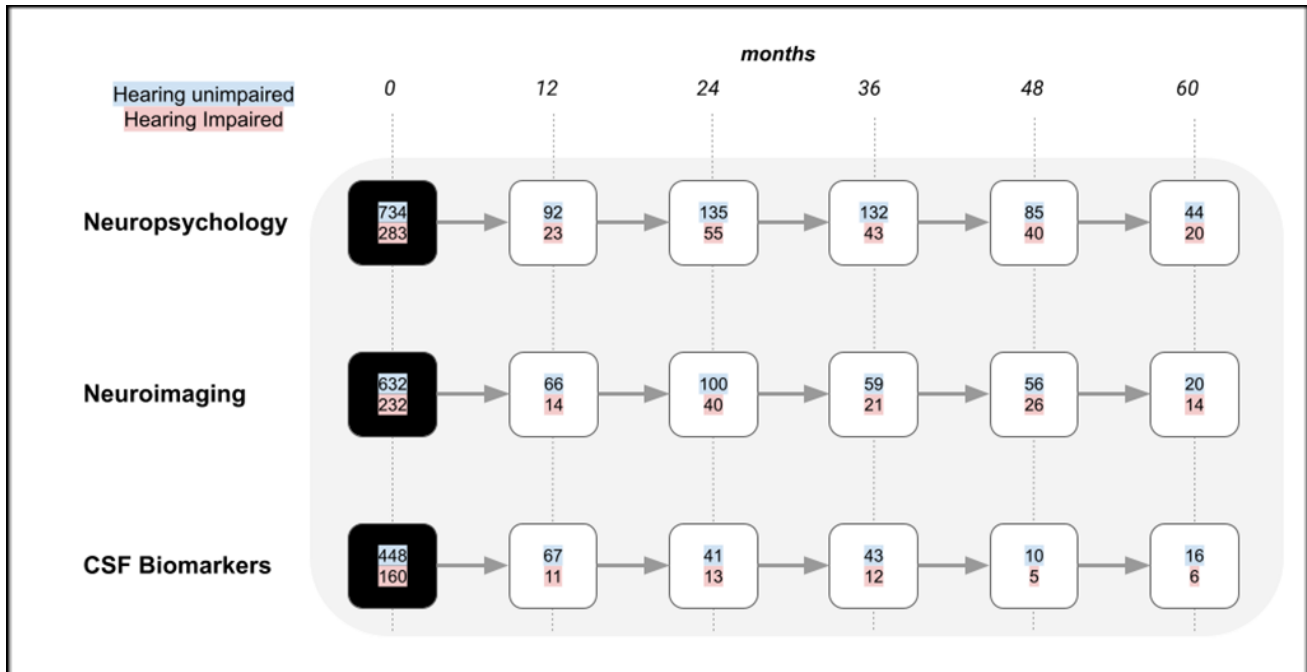

Figure 3.3. A flowchart showing the number of participants with MCI that converted to a diagnosis of AD dementia at 12-month intervals. The different rows indicate the total number of participants that completed neuropsychological, neuroimaging or CSF biomarker evaluation. The number of hearing unimpaired participants are indicated with a blue background and those with self-reported hearing impairment have a red background. The first time point (with a black background) acted as a baseline from which a change in neuropsychological, neuroimaging and biochemical measures was calculated at each subsequent timepoint.

Table 3.1 - Baseline participant characteristics

| | <u>Cognitively Normal</u> | | <u>Mild Cognitive Impairment</u> | |
|--------------------------------|---------------------------|------------------|----------------------------------|------------------|
| | Hearing Normal | Hearing Impaired | Hearing Normal | Hearing Impaired |
| Count (n) | 605 | 197 | 734 | 283 |
| <u>Demographics</u> | | | | |
| Age (years) | 73.2 (5.5) | 75.9 (5.8) | 71.2 (7.3) | 75.3 (6.4) |
| <u>Gender (n)</u> | | | | |
| Male | 248 | 116 | 394 | 211 |
| Female | 357 | 82 | 340 | 72 |
| Education (years) | 16.2 (2.6) | 16.9 (2.6) | 15.9 (2.9) | 16.1 (3.0) |
| <u>Cognitive Scores</u> | | | | |
| MMSE (/30) | 29.1 (1.0) | 29.1 (1.2) | 27.8 (1.8) | 27.4 (1.7) |
| RAVLT (/50) | 45.6 (9.9) | 44.8 (10.0) | 34.7 (10.8) | 33.0 (9.8) |
| <u>Neuroimaging</u> | | | | |
| TIV (ml) | 1496.1 (158) | 1538.3 (158) | 1545.5 (164) | 1556.1 (169) |
| Hippocampal volume (ml) | 7.4 (0.9) | 7.4 (0.8) | 7.0 (1.1) | 6.8 (1.1) |
| <u>Fluid Biomarkers</u> | | | | |
| pTau-181 +ve | 4 | 2 | 20 | 11 |

Baseline characteristics for all participants without a diagnosis of AD dementia.

MMSE- Mini-Mental State Examination, RAVLT- Rey Adult Verbal Learning Test, TIV- Total Intracranial Volume, pTau-181- Phosphorylated Tau-181. Variability for numerical group level statistics is indicated as a standard deviation.

3.3.2. Hearing Characteristics

697 people (29% of total participants) with hearing impairment were identified from participant records. 283 had bilateral hearing impairment, 71 had unilateral impairment. 70 had mild hearing impairment, 112 had moderate impairment and 116 had severe impairment. Figures 3.1 and 3.2 show the progression of cognitively normal participants and MCI participants, divided into hearing-unimpaired and hearing-impaired groups, over a five-year period at 12-month intervals. Figure 3.3 shows participants with MCI that converted to AD dementia at 12-month intervals up to a follow-up period of five years.

3.3.3. Neuropsychological comparisons

There were no significant differences in MMSE scores between cognitively normal hearing unimpaired and hearing impaired participants at 12 months ($F(1, 468) = 0.48, p = 0.45, np^2 = 0.001$), 24 months ($F(1, 562) = 3.23, p = 0.07, np^2 = 0.006$), 36 months ($F(1, 240) = 0.85, p = 0.36, np^2 = 0.004$), 48 months ($F(1, 330) = 0.69, p = 0.41, np^2 = 0.002$) and 60 months ($F(1, 130) = 0.01, p = 0.91, np^2 < 0.001$), after controlling for age, gender, APOE4 status and years of education and Bonferroni correction for multiple comparisons.

There were no significant differences in RAVLT scores between cognitively normal hearing unimpaired and hearing impaired participants at 12 months ($F(1, 466) = 9.72, p = 0.002, np^2 = 0.020$), 24 months ($F(1, 558) = 1.81, p = 0.18, np^2 = 0.003$), 36 months ($F(1, 234) = 1.08, p = 0.30, np^2 = 0.005$), 48 months ($F(1, 327) = 2.81, p = 0.09, np^2 = 0.008$) and 60 months ($F(1, 129) = 1.37, p = 0.24, np^2 = 0.010$), after controlling for age, gender, APOE4 status and years of education and Bonferroni correction for multiple comparisons (Figure 4A).

There were no significant differences in MMSE scores between MCI hearing unimpaired and hearing impaired participants at 12 months ($F(1, 890) = 1.54, p = 0.21, np^2 = 0.002$), 24 months ($F(1, 727) = 0.10, p = 0.75, np^2 < 0.001$), 36 months ($F(1, 612) = 1.21, p = 0.27, np^2 = 0.002$), 48 months ($F(1, 411) = 0.82, p = 0.37, np^2 = 0.002$) and 60 months ($F(1, 239) = 0.44, p = 0.51, np^2 = 0.002$), after controlling for age, gender, APOE4 status and years of education and Bonferroni correction for multiple comparisons.

There were no significant differences in RAVLT scores between MCI hearing unimpaired and hearing impaired participants at 12 months ($F(1, 887) = 0.09, p = 0.77, np^2 < 0.001$), 24 months ($F(1, 721) = 0.50, p = 0.48, np^2 = 0.001$), 36 months ($F(1, 607) = 0.02, p = 0.89, np^2 < 0.001$), 48 months ($F(1, 404) = 0.30, p = 0.58, np^2 < 0.001$) and 60 months ($F(1, 226) = 0.11, p = 0.74, np^2 = 0.001$), after controlling for age, gender, APOE4 status and years of education and Bonferroni correction for multiple comparisons (Figure 4B).

Amongst participants who converted to AD dementia, there were no significant differences in MMSE scores at baseline between hearing unimpaired and hearing impaired participants for those who converted at 12 months ($F(1, 108) = 0.05, p = 0.821, np^2 < 0.001$), 24 months ($F(1, 187) = 0.41, p = 0.52, np^2 = 0.002$), 36 months ($F(1, 177) = 0.42, p = 0.52, np^2 = 0.002$), 48 months ($F(1, 127) = 0.56, p = 0.46, np^2 = 0.004$) and 60 months ($F(1, 70) = 0.07, p = 0.80, np^2 < 0.001$), after controlling for age, gender, APOE4 status and years of education and Bonferroni correction for multiple comparisons.

Amongst participants who converted to AD dementia, there were no significant differences in RAVLT scores at baseline between hearing unimpaired and hearing impaired participants for those who converted at 12 months ($F(1, 108) = .013, p = 0.72, np^2 = 0.001$), 24 months ($F(1, 187) = 0.33, p = 0.57, np^2 = 0.002$), 36 months ($F(1, 177) = 2.09, p = 0.15, np^2 = 0.012$), 48 months ($F(1, 127) = 1.26, p = 0.26, np^2 = 0.010$) and 60 months ($F(1, 70) = 0.26, p = 0.61, np^2 = 0.004$), after controlling for age, gender, APOE4 status and years of education and Bonferroni correction for multiple comparisons.

3.3.4. *Neuroimaging comparisons*

There were no significant differences in normalised whole brain volumes between cognitively normal hearing unimpaired and hearing impaired participants at 12 months ($F(1, 423) = 0.02, p = 0.89, np^2 < 0.001$), 24 months ($F(1, 460) = 0.59, p = 0.44, np^2 = 0.001$), 36 months ($F(1, 165) = 0.45, p = 0.50, np^2 = 0.003$), 48 months ($F(1, 210) = 3.24, p = 0.07, np^2 = 0.015$) and 60 months ($F(1, 95) = 0.04, p = 0.83, np^2 < 0.001$), after controlling for age, gender, APOE4 status and years of education and Bonferroni correction for multiple comparisons.

There were no significant differences in normalised hippocampal volumes between cognitively normal hearing unimpaired and hearing impaired participants at 12 months ($F(1, 377) = 0.01, p = 0.92, np^2 < 0.001$), 24 months ($F(1, 425) = 1.23, p = 0.27, np^2 = 0.003$), 36 months ($F(1, 194) = 0.12, p = 0.73, np^2 = 0.001$), 48 months ($F(1,) = 2.81, p = 0.09, np^2 = 0.008$) and 60 months ($F(1, 73) = 5.49, p = 0.02, np^2 = 0.070$), after controlling for age, gender, APOE4 status and years of education and Bonferroni correction for multiple comparisons (Figure 5A).

There were no significant differences in normalised whole brain volumes for MCI hearing unimpaired and hearing impaired participants for those who converted at 12 months ($F(1, 108) = 0.05, p = 0.821, np^2 < 0.001$), 24 months ($F(1, 187) = 0.41, p = 0.52, np^2 = 0.002$), 36 months ($F(1, 177) = 0.42, p = 0.52, np^2 = 0.002$), 48 months ($F(1, 127) = 0.56, p = 0.46, np^2 = 0.004$) and 60 months ($F(1, 70) = 0.07, p = 0.80, np^2 < 0.001$), after controlling for age, gender, APOE4 status and years of education and Bonferroni correction for multiple comparisons.

There were no significant differences in normalised hippocampal volumes at baseline between MCI hearing unimpaired and hearing impaired participants for those who converted at 12 months ($F(1, 634) = 1.41, p = 0.23, np^2 = 0.002$), 24 months ($F(1, 505) = 0.05, p = 0.82, np^2 < 0.001$), 36 months ($F(1, 227) = 2.22, p = 0.14, np^2 = 0.010$), 48 months ($F(1, 229) = 0.04, p = 0.85, np^2 < 0.001$) and 60 months ($F(1, 95) = 0.63, p = 0.43, np^2 = 0.007$), after controlling for age, gender, APOE4 status and years of education and Bonferroni correction for multiple comparisons (Figure 5B).

Amongst participants who converted to AD dementia, there were no significant differences in normalised whole brain volumes at baseline between MCI hearing unimpaired and hearing impaired participants at 12 months ($F(1, 95) = 0.03, p = 0.86, np^2 < 0.001$), 24 months ($F(1, 150) = 0.46, p = 0.50, np^2 = 0.003$), 36 months ($F(1, 92) = 0.06, p = 0.80, np^2 = 0.001$), 48 months ($F(1, 84) = 0.72, p = 0.40, np^2 = 0.009$) and 60 months ($F(1, 33) = 0.29, p = 0.59, np^2 = 0.009$), after controlling for age, gender, APOE4 status and years of education and Bonferroni correction for multiple comparisons.

Amongst participants who converted to AD dementia, there were no significant differences in normalised hippocampal volumes at baseline between cognitively normal hearing unimpaired and hearing impaired participants at 12 months ($F(1, 68) = 0.16, p = 0.69, np^2 = 0.002$), 24 months ($F(1, 122) = 1.58, p = 0.21, np^2 = 0.013$), 36 months ($F(1, 63) = 0.53, p = 0.47, np^2 =$

0.008), 48 months ($F(1, 69) = 1.21, p = 0.27, np^2 = 0.017$) and 60 months ($F(1, 26) = 1.47, p = 0.24, np^2 = 0.053$), after controlling for age, gender, APOE4 status and years of education and Bonferroni correction for multiple comparisons.

3.3.5. *pTau positivity*

There were no significant differences in pTau positivity between cognitively normal hearing unimpaired and hearing impaired participants at 12 months ($F(1, 87) = 0.07, p = 0.80, np^2 = 0.001$), 24 months ($F(1, 151) = 1.25, p = 0.27, np^2 = 0.008$), 36 months ($F(1, 25) = 1.59, p = 0.22, np^2 = 0.060$), 48 months ($F(1, 64) = 0.25, p = 0.62, np^2 = 0.004$) and 60 months ($F(1, 15) = 1.45, p = 0.25, np^2 = 0.089$), after controlling for age, gender, APOE4 status and years of education and Bonferroni correction for multiple comparisons.

There were no significant differences in pTau positivity between MCI hearing unimpaired and hearing impaired participants at 12 months ($F(1, 148) = 1.34, p = 0.25, np^2 = 0.009$), 24 months ($F(1, 246) = 0.55, p = 0.46, np^2 = 0.002$), 36 months ($F(1, 38) = 4.18, p = 0.05, np^2 = 0.010$), 48 months ($F(1, 104) = 0.34, p = 0.56, np^2 = 0.003$) and 60 months ($F(1, 16) = 1.22, p = 0.28, np^2 = 0.071$), after controlling for age, gender, APOE4 status and years of education and Bonferroni correction for multiple comparisons.

Amongst participants who converted to AD dementia, there were no significant differences in pTau positivity at baseline between hearing unimpaired and hearing impaired participants for those who converted at 12 months ($F(1, 72) = 0.35, p = 0.55, np^2 = 0.005$), 24 months ($F(1, 48) = 3.60, p = 0.06, np^2 = 0.070$), 36 months ($F(1, 49) = 0.24, p = 0.63, np^2 = 0.005$), 48 months ($F(1, 9) = 0.54, p = 0.48, np^2 = 0.057$) and 60 months ($F(1, 16) = 0.08, p = 0.78, np^2 = 0.004$), after controlling for age, gender, APOE4 status and years of education and Bonferroni correction for multiple comparisons.

3.3.6. *Survival analysis of hearing loss as a risk factor for AD dementia*

The CPH model was used to assess the risk of dementia conversion in relation to hearing loss while adjusting for age, gender, years of education, and APOE4 genotype. The adjusted survival curves for individuals with and without hearing loss overlapped considerably throughout the observation period, suggesting similar survival probabilities between the two groups. This is indicated by the coefficients of the model in Table 3.2 and figure 3.4.

Specifically, hearing loss status was not found to be a significant predictor of dementia conversion. The hazard ratio for hearing loss, compared to no hearing loss, was -0.2 (95% CI: -0.47 to 0.06, $p = 0.13$). This indicates that individuals with hearing loss did not have a significantly different risk of converting to dementia compared to those without hearing loss, after adjusting for the included covariates.

Table 3.2 - Cox Proportional Hazard Model Summary

| | <u>Coefficient</u> | <u>z-score</u> | <u>p-value</u> |
|---------------------|---------------------------|-----------------------|-----------------------|
| Age | 0.03 (0.02-0.05)* | 4.02 | <0.005 |
| Sex | -0.06 (-0.30-0.17) | -0.52 | 0.6 |
| Education | -0.01 (-0.06-0.03) | -0.71 | 0.48 |
| APOE4 | 0.66 (0.50-0.81)* | 8.12 | <0.005 |
| Hearing Loss | -0.20 (-0.47-0.06) | -1.51 | 0.13 |

Results of the Cox Proportional Hazard model for predicting conversion from MCI to AD dementia in the ADNI cohort. Separate covariate parameter coefficients, the z-scores associated with these and their p-values are shown. Confidence intervals for the coefficients are shown in parenthesis. Asterisks indicate statistically significant values.

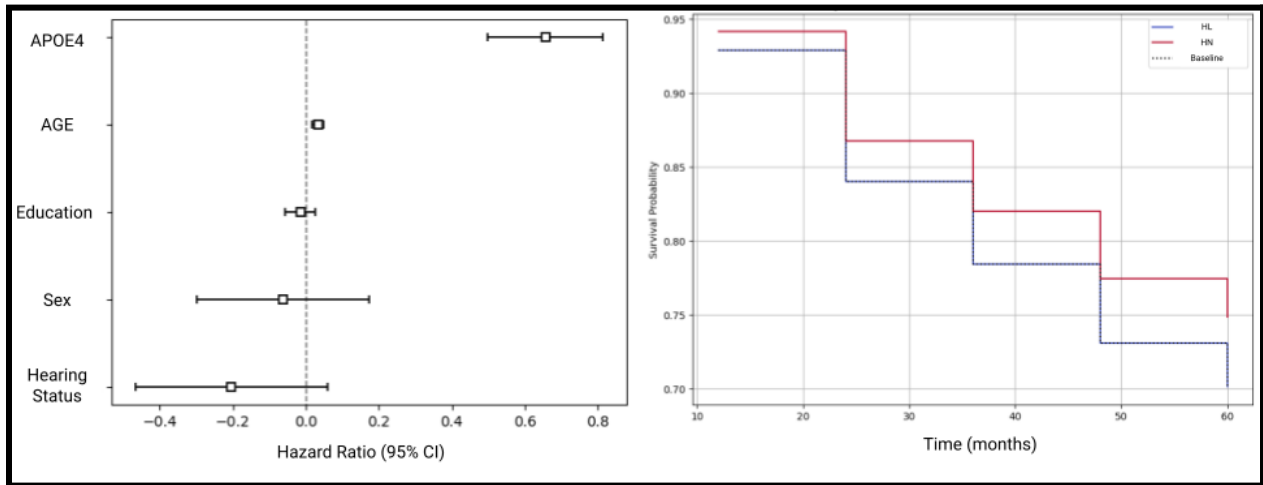

Figure 3.4. Cox Proportional Hazard (CPH) analysis for conversion from MCI to AD Dementia. The image on the left shows the hazard ratios estimated by the CPH model for various covariates. APOE4 status has the largest impact on conversion to dementia, followed by age. The image on the right shows adjusted survival curves for people with (HL) (blue line) and without (HN) (red line) hearing loss. There is no significant impact on dementia conversion based on hearing status. HL - Hearing Loss, HN - Hearing Normal, CI - Confidence Interval

3.4. Discussion

This study was designed to assess whether the presence of subjective hearing loss is predictive of AD dementia through changes in clinically relevant cognitive, neuroimaging or cerebrospinal fluid biochemical markers of AD. I found that there were no significant differences between hearing impaired and hearing unimpaired participants in cognitively normal and people with MCI over a 5-year period nor were there any group-level changes in these variables in people who had converted from MCI to AD dementia. There were also no significant differences in the risk of dementia for people with or without hearing loss. Subjective hearing impairment may thus have a limited value in predicting AD dementia risk.

3.4.1. *Subjective hearing loss is not associated with faster cognitive decline, hippocampal atrophy or pTau positivity*

Episodic memory impairment is a hallmark of AD dementia and forms part of the initial diagnostic criteria for the condition (McKhann et al., 2011). Decline in episodic memory on the RAVLT and other tests of delayed verbal recall has been shown to predict AD dementia development (Chen et al., 2000; Rubin et al., 1998). Subjective hearing loss has also been linked to an increased risk of cognitive impairment compared to hearing unimpaired individuals (Brewster et al., 2021). A decline in episodic memory scores in preclinical AD, however, has not been found to be predictive of AD itself in other studies (Bäckman et al., 2001). In this study, I did not find a faster decline in RAVLT scores in people with subjective hearing impairment in cognitively unimpaired individuals or those with MCI, over a 5-year period. This would indicate that there may not be early cognitive changes relevant to the risk for AD dementia in those with subjective hearing loss. Participants with MCI who converted to AD dementia over a 5-year period also did not have faster cognitive decline than hearing unimpaired participants. These findings suggest that subjective hearing impairment may not be directly related to early cognitive markers of AD dementia over a shorter time span.

The most common form of AD dementia is also associated with hippocampal volume loss and atrophy in this region can also increase the risk of AD dementia in healthy individuals and those with pre-clinical AD (Apostolova et al., 2010; Barnes et al., 2009). Hearing loss, as defined by pure tone audiometry, has also been associated with faster rates of medial temporal lobe and

hippocampal atrophy (Armstrong et al., 2019; Lin et al., 2014). However, this study did not find any group-level differences between participants with subjective hearing impairment and hearing unimpaired participants after 5-years. Participants with mild cognitive impairment who converted to AD dementia over this time period also did not have any brain metric differences at baseline that would help predict dementia. Therefore, subjective hearing impairment may not lead to greater hippocampal atrophy in these populations over time.

There is great interest in neurodegenerative markers, which can predict conversion to AD dementia with a high degree of accuracy (Karikari et al., 2022). Phosphorylated tau-181 levels are predictive of conversion and I used a potentially clinically relevant cut-off (Palmqvist et al., 2021). Previous studies have found an association between subjective hearing loss and raised pTau-181 in the ADNI cohort (Xu et al., 2019). However, it is unclear whether this actually increases the risk of AD dementia in the future. I did not replicate this finding with the most updated version of the ADNI dataset. Neuropathological changes are also more evident in hearing impaired individuals compared to hearing unimpaired individuals (Brenowitz et al., 2020). However, I did not find that pTau-181 was preferentially predictive of AD dementia conversion over 5 years in the participants with subjective hearing loss.

The survival analysis also showed that the MCI groups with and without hearing loss were not significantly different in their risk of dementia. APOE4 was the covariate that increased the risk for conversion by the largest margin followed by age. These are well-recognised risk factors for AD dementia (Belloy et al., 2019; Dickerson et al., 2017). The lack of association with poor subjective hearing and an increased dementia risk goes against the findings using objective measures (Gates et al., 2002; Livingston et al., 2020). This is also contrary to other studies linking poor subjective hearing and an increased dementia risk (Gurgel et al., 2014). However, in this study the assessment of whether a participant had hearing loss was made by the researcher assessing the patient during an interview, rather than it being a self-reported measure.

3.4.2. *Strengths and Limitations*

The longitudinal study design and the use of clinically relevant predictive markers of AD diagnosis as outcome variables is a strength of this study. I analysed metrics that could

differentiate people at greater risk of AD dementia if subjective hearing loss instantiated this risk. This would allow a quick assessment of subjective hearing loss to be used alongside cognitive, neuroimaging and biochemical testing in the clinical environment. The study was conducted with the latest available dataset from the ADNI study and with participants where hearing loss is most likely to have an influence on disease markers, if a true neurobiological link between subjective hearing loss and dementia exists. However, subjective hearing loss was not associated with group level differences in the chosen variables.

There are possible explanations for lack of association between subjective hearing loss and established markers that predict AD dementia. Firstly, there is a poor association between subjective and objective hearing measures which may not capture the evidence link between hearing loss and subsequent dementia (Tsimpida et al., 2020). One study found the use of subjective hearing impairment over-represents the presence of hearing loss as over half of participants did not have hearing loss as defined by thresholds (Hannula et al., 2011). Although subjective hearing loss correlates with hearing disability, it is insensitive to age effects. It overestimates hearing loss below 70 years of age and underestimates that in people above 70 years of age (Kiely et al., 2012). Therefore, it is possible the specific subjective hearing loss metric used in this study may not capture the relationship that has been identified between objective hearing loss and future dementia risk and a more comprehensive one is required.

Another factor may have been that the percentage of hearing impaired participants was around 30% in this cohort at a mean age of 73 years of age when one would expect greater than 70% to have some form of hearing loss (Lin et al., 2011b). The lack of objective data on hearing in ADNI made it difficult to establish whether milder hearing loss was overrepresented in this cohort where one would expect a weaker link between hearing loss and dementia risk. Data on when an individual acquired hearing loss as it may be associated with a greater risk of dementia at early rather than later stages (Loughrey et al., 2018). Finally, in this study, people with hearing impairment were less likely to complete the follow-up period of 5 years and had a bigger drop-off at each time point. This censoring effect may have contributed to the lack of identification of an association between subjective hearing loss and AD dementia risk.

3.4.3. *Implications*

It is possible that subjective hearing loss increases a person's future AD dementia risk by other mechanisms. Further work is necessary to assess whether subjective hearing ability is related to an individual's resilience against dementia and then be a useful metric in that regard. Sensory loss, in general, may give an indication of an individual's resilience against dementia (Lad et al., 2022). Metacognitive markers like subjective memory loss have been shown to have a similar risk for dementia as early mild cognitive impairment but the mechanisms for this relationship are unclear (Jessen et al., 2014). It is also possible that neuropathology related to other dementia syndromes, rather than AD, is better associated with hearing loss. Poor subjective hearing is also associated with poor quality of life and there may be psychological factors such as low mood at play which independently predict dementia risk (Dawes et al., 2015; Gopinath et al., 2012). Self reported hearing handicap, rather than clinical measured hearing impairment, predicted a decline in quality of life over a 10-year period suggesting that associated psychological and social factors may be more important in determining well-being in older adults.

The findings from this study have implications for the analysis of dementia risk from other large-scale cohorts. Information regarding hearing status is usually captured in a dichotomous form, as was performed in this study, based on the presence or absence of self-reported hearing difficulties. Despite being a quick measurement of hearing status, it may not be able to replace objective hearing measurements of pure-tone audiometry thresholds or speech-in-noise perception ability which have been directly associated with future dementia risk. Even if there are clear individual risks for dementia associated with subjective hearing loss these may be due to psychological factors independently associated with the condition. Future cohort studies or amendments to existing cohort studies should include an assessment of objective hearing metrics so that the mechanisms for the association between hearing loss and dementia can be clarified.

4. Speech-in-Noise Perception and Auditory Memory in Ageing

4.1. Introduction

There are several changes that may take place in the ageing auditory system that could have a negative impact on SiN perception. Genetic, personal and environmental factors may all contribute to this to varying degrees. The study described in this chapter assesses how demographic and various auditory perceptual and cognitive metrics are related to SiN ability. I first describe the changes that are known to occur from the existing literature in the auditory system due to ageing and then present the main findings of the AudCog study. Finally, I present evidence for cognitive models that might best capture the relationships between cognition, peripheral hearing and SiN perception ability.

4.1.1. *Changes in the peripheral auditory system*

Age-related changes in the peripheral auditory system, termed presbycusis, have been well described. Degenerative alterations in the cochlea produces the kind of high-frequency hearing loss. There are classically three types: sensory, strial and neural forms of presbycusis (Gates and Mills, 2005).

By around 60 years of age, most people develop an elevation of their hearing thresholds at high frequencies. Post-mortem studies in aged humans and animals have identified loss of the outer hair cells in the basal cochlea, the region that facilitates hearing in the high frequency range. This is termed sensory presbycusis and is also notably caused by excessive noise exposure. A number of histopathological studies have demonstrated a correlation between the loss of hair cells, particularly outer hair cells, and age-related hearing loss (Schuknecht and Gacek, 1993). These studies have shown that the number of hair cells, especially in the basal region of the cochlea (responsible for high-frequency hearing), decreases with age. The reduction in hair cells has been associated with a decline in hearing sensitivity at corresponding frequencies, as observed in pure tone audiograms.

One of the other most prominent anatomical characteristics of age-related hearing loss is degeneration of the stria vascularis, a vascular structure with a high metabolic rate in the cochlea. Atrophy or degeneration of the stria vascularis may cause a decline in the endocochlear potential, impairing the hair cells' ability to transduce sound signals effectively (Schuknecht et al., 1974). This potential is essential for the transduction of sound vibrations into electrical signals by hair cells. The audiogram of laboratory animals with degeneration of the stria corresponds closely to the audiograms of ageing humans. (Schmiedt et al., 2002).

There may be changes in the peripheral auditory system that occur with presbycusis that present despite normal PTA performance (Chen, 2018). This is termed hidden hearing loss and is primarily related to neural factors promoting auditory processing (Liberman and Kiang, 1978). Individuals with hidden hearing loss may exhibit normal audiogram results and have no apparent difficulty hearing in quiet environments, yet struggle to understand speech in noisy situations. It is thought to be associated with damage to the synapses between the inner hair cells and the auditory nerve fibres, also known as cochlear synaptopathy. In noisy situations, the auditory system relies on the precise timing of auditory nerve fibre responses to detect and separate different sound sources, such as speech from background noise (Parthasarathy and Kujawa, 2018). The loss of synapses in cochlear synaptopathy can impair this temporal precision which is important for SiN perception ability.

4.1.2. Changes in the central auditory system

The ageing central auditory system also undergoes various changes that can impact auditory processing relevant to perception and cognition. Age-related degeneration of neurons occurs in areas such as the spiral ganglion neurons, superior olivary complex, inferior colliculus, medial geniculate nucleus, and auditory cortex as evidenced from animal studies (Idrizbegovic et al., 2001; Turner et al., 2005; Willott et al., 1988). This neural degeneration can lead to decreased transmission efficiency of auditory signals and contribute to difficulties in processing complex auditory information. Ageing can also result in a reduced ability of auditory neurons to synchronise their responses to sound stimuli as neurophysiological responses to sound change (Harris and Dubno, 2017). This reduced neural synchrony can impair temporal processing, which is critical for sound localisation, speech perception and the ability to separate sounds in noisy environments.

There are neurotransmitter related changes in the central auditory brain that can impact auditory processing. Reduced inhibitory neurotransmitter activity may lead to increased neural noise and reduced signal-to-noise ratio, making it difficult to process auditory information in challenging listening situations, such as understanding speech in noisy environments (Casparly et al., 2008). The ageing brain also undergoes reorganisation in response to age-related changes in the central auditory system (Husain et al., 2014). This reorganisation may involve compensatory mechanisms or maladaptive changes, which can either help or hinder auditory processing. For example, compensatory mechanisms may engage additional brain regions to support 'normal' auditory processing, while maladaptive changes could lead to a decline in auditory performance.

Age-related cognitive decline can also impact auditory processing, as the central auditory system inputs into other cognitive systems, such as those for attention, memory, and executive function (Grady, 2012). Cognitive decline can affect an individual's ability to focus on relevant auditory information, recall auditory memories and process complex auditory stimuli, such as speech. Research has shown a correlation between performance on SiN tests and cognitive function in older adults (Moore et al., 2014). Assessing SiN perception can therefore provide insights into the influence of cognitive factors on auditory processing.

4.1.3. Aims and objectives

The overarching goal of this study was to examine the effect of peripheral and cognitive factors on SiN perception and the interaction of these with ageing. In this study, I used two different tests to illustrate how cognitive factors are differentially involved in SiN perception depending on the test used: the Digits-in-Noise (DiN) test and the Speech-in-Babble (SiB) test. These tests, or tests of a similar nature, are very widely used in SiN perception research but they differ in the type of stimuli used to probe SiN perception, the duration of stimuli and the semantic complexity of the stimuli used. The three objectives were to:

1. Establish normative data in peripheral and central hearing abilities using established and novel tests of central hearing
2. Examine the ability of peripheral and central hearing abilities to predict the DiN and SiB task performance.

3. Establish the validity of a model for SiN perception ability based on factors related to ageing and those related to auditory cognition.

4.2. Methods

This study was approved by the Oxford C NHS Research Ethics Committee - 21/SC/0139.

4.2.1. *Participants*

143 participants (91 female) were recruited into the AudCog study from March 2022 until July 2023. As mentioned in Chapter 2, these participants were invited to participate from a variety of sources including the Join Dementia Research register, local volunteer databases at Newcastle University and through word of mouth. Spouses of patients with memory and thinking problems from Neurology and Old Age Psychiatry Memory Clinics were also invited to participate. The age range of participants was 50 - 86 years with a mean of 66 and a standard deviation of 10. 21 participants were active hearing aid users. These participants did not have any active neurological or psychiatric medical condition. All participants had the opportunity to go through a Participant Information Leaflet before enrolment in the study.

4.2.2. *Auditory and Behavioural Testing Procedure*

Each participant had a 1-hour visit to the Auditory Laboratory at the Newcastle University Medical School. The testing session involved written consent, pure-tone audiometry, computerised auditory cognitive testing, filling a questionnaire of musical sophistication and finally a cognitive screening test using the ACE-III. All tests were carried out by Dr. Lad.

PTA testing for air conduction was performed in the following order: 250Hz → 500Hz → 1000Hz → 2000Hz → 4000Hz → 8000Hz first for the left ear then the right ear as described in Chapter 2 using an Interacoustics AS608e screening audiometer. This was performed in a soundproof booth. Tones were manually presented as short bursts twice starting at 30dB then increased in 5dB increments until comfortably audible if necessary. Then 5dB reductions were made until the tone was not audible. This process was repeated twice and the lowest audible volume was

chosen as the value for a particular frequency. If maximum amplification at 100dB could not be perceived then this was used as the ceiling value at a particular frequency. The mean of high frequency values between 4000Hz to 8000Hz for the best ear was taken as the mean threshold value for an individual for further analysis.

The computerised auditory testing was performed using Sennheiser HD 201 circumaural headphones in a soundproof booth. The testing was semi-structured with a pure tone at 800 Hz being presented binaurally and the volume (starting at 70dB) being adjusted for comfort if necessary. Then the participant had to confirm that the tone was being presented to each ear separately. Next a test of Huggins Pitch perception was performed (Cramer and Huggins, 1958). The stimulus consists of white noise introduced in one ear whilst the same white noise is phase transformed in a narrow band (6% around 600Hz) and played to the other ear. This results in the perception of a faint tone, corresponding in pitch to the centre frequency of the phase-shifted band, embedded in noise. The 1-sec stimulus was played up to four times for each participant and if they were able to perceive the pitch within the white noise they participated in a short test consisted of six trials where they had to choose the white noise stimulus that had the pitch percept from a set of three sounds played in a sequence with an interstimulus interval of 200ms. The next stage comprised the SiB, DiN and AuM tasks chosen in a random order for each participant.

The SiB task consisted of participants listening to sentences on a background of 16-talker babble as described previously by our research group (Figure 4.1) (Holmes and Griffiths, 2019; Lad et al., 2020). Target sentences had the form <name> <verb> <number> <adjective> <noun> (e.g. "Alan gives four pretty flowers") and participants had to click on the correct word from a list of five columns (10 options for each word) shown on the screen with the same structure. An adaptive 1-up, 1-down psychophysical paradigm was implemented whereby a correct response resulted in the SNR being reduced and an incorrect one caused the SNR to increase. The starting SNR was 0 dB and the step sizes decreased from 5 to 2 dB after 3 reversals, which then reduced to 0.5 dB after 3 more reversals. The run terminated after 10 reversals and the SNR at the last 5 reversals was averaged to calculate the SiB threshold for each participant. Lower SNR values indicated a better performance. Participants had two practice trials at the beginning of the task to familiarise themselves with the stimuli at an SNR of 10dB. The DiN task involved participants listening to three digits on a background of speech-shaped white noise (Figure 4.2). The task was dichotic in nature as the signal in the right headphone channel was

antephasic to that in the left channel. Studies have shown that testing DiN perception ability in this way produces results that associate better with PTA metrics (De Sousa et al., 2020). The starting parameters and the adaptive design was exactly the same as the SiB task. Participants had two practice trials at the beginning of the task to familiarise themselves with the stimuli at an SNR of 10dB.

The AuM task was presented as described in Chapter 2 and figure 2.2. Briefly, a one-second tone or AM modulated white noise stimulus was presented to a participant after which they were asked to ‘find’ the sound on a horizontal scale on a computer screen. Participants had to move a mouse and click on the line to produce a sound at that location. They could make as many clicks as they wanted with no set time limit. After they were satisfied with their choice they would advance to the next trial by pressing the ‘Enter’ key on a keyboard. Frequencies that determined the pure-tone sounds were chosen from a uniform distribution between 440-880 Hz and AM rates for the white noise stimulus were 5-20 Hz with a sinusoidal function used to apply this modulation. Hanning windows were applied to all synthetic sounds to avoid clicks and the beginning and end of the stimuli. The task consisted of 32 trials with the frequency and AM rate matching trials being interleaved. Participants had a short break after 16 trials. As described in Chapter 2, a Gaussian function was used to estimate the standard deviation of the errors in each trial across the whole experiment and the inverse of this value, the precision, was used for further analysis. Thus, one obtains a precision for frequency AuM and AM rate AuM. Participants had two practice trials with each stimulus (2 for frequency and 2 for AM rate AuM) at the beginning of the task to familiarise themselves with the stimuli.

Finally, participants completed the short-version of the Goldsmiths Musical Sophistication Index questionnaire consisting of 38 questions on paper (Müllensiefen et al., 2014). The ACE-III was the last test to be completed and all participants underwent a debrief at the end.

4.2.3. *Statistical Analysis*

Descriptive statistics was performed using Jupyter Notebooks in Python 3.9. Linear models were created to assess the effect of age on hearing metrics using the Pingouin module. AuM measures were log-transformed to convert them into normal distributed values. Multivariate models were created using age, PTA thresholds and AuM scores using the SciPy module and

model comparison was performed using Bayesian Information Criterion (BIC) to evaluate the best model predicting DiN performance and another predicting SiB performance. BIC was used instead of the Akaike Information Criterion as the latter tends to overfit the data by using more parameters. Bayes Factors were calculated using the Cauchy distribution with a scale parameter of 0.707 as a prior distribution.

To understand the relationship between various cognitive, auditory and demographic factors, and their combined influence on a specific hearing measure, Structural Equation Modelling was employed. This multivariate statistical technique allowed me to account for latent constructs that are not directly observable but inferred from multiple observed variables. There were two latent constructs in the model: 1. Age-related Hearing Ability: Derived from participants' age and a standard hearing sensitivity measure from the PTA scores; 2. Cognitive & Auditory Cognitive Ability: Composed of the total ACE-3 score scores, AuM precision for frequency and AuM precision for AM rate. Age was only added to the first variable due to pilot work suggesting a stronger linear relationship with PTA thresholds. Both these latent constructs were then used to predict the composite SiN hearing measure. The model was estimated using a maximum likelihood estimation method. The adequacy of the model fit to the data was assessed using various fit indices including the Root Mean Square Error of Approximation (RMSEA), the Comparative Fit Index (CFI) and the Tucker-Lewis Index (TLI). These indices provided insights into how well my proposed model represented the relationships within the observed data.

4.3. Results

4.3.1. *Pure tone audiometry*

PTA thresholds were normally distributed. Out of the 132 participants, 18 (12%) participants had normal hearing, 35 (23%) had mild hearing loss, 52 (34%) had moderate hearing loss and 47 (31%) had severe hearing loss. The severity of hearing loss increased with age as shown in figure 4.3. The bivariate linear relationship between Age and PTA Hearing Threshold was moderately strong ($R = 0.57$ [0.45, 0.67], $p < 0.001$, $BF > 1000$).

4.3.2. Central hearing tests

A participant was considered to have passed the Huggins Pitch perception test if they correctly identified the sound that evokes a pitch percept in five or all six trials. 103 (67.7%) participants passed this test. Participants were less likely to pass the test if they were older ($\chi^2 = 12.4$, $p = 0.03$) or had hearing impairment ($\chi^2 = 22.1$, $p < 0.001$) (Figure 4.4).

DiN and SiB thresholds were normally distributed and were transformed into z-scores for further analysis. There was a weak linear relationship between DiN performance and age after performing a partial correlation with PTA thresholds as a covariate ($R = -0.24$ [-0.4, -0.08], $p < 0.005$, $BF = 2.39$) (Figure 4.5). This was also observed between SiB thresholds and age after using PTA scores as a covariate ($R = -0.19$ [-0.35, -0.02], $p < 0.05$, $BF = 2.44$).

AuM scores underwent a logarithmic transformation to normalise the data distribution and a transformation to z-scores for further analysis. Although both AuM precision for frequency and AM rate were both related to Age, AM rate was significantly associated with a linear relationship ($R = -0.29$ [-0.43, -0.12], $p > 0.05$, $BF = 2.37$) whereas AuM for frequency was not ($R = -0.08$ [-0.25, 0.09], $p < 0.001$). As published previously, AuM for frequency was significantly associated with musical sophistication scores on the GMSI questionnaire ($R = 0.45$ [0.3, 0.58], $p < 0.001$, $BF > 5000$) (Lad et al., 2021).

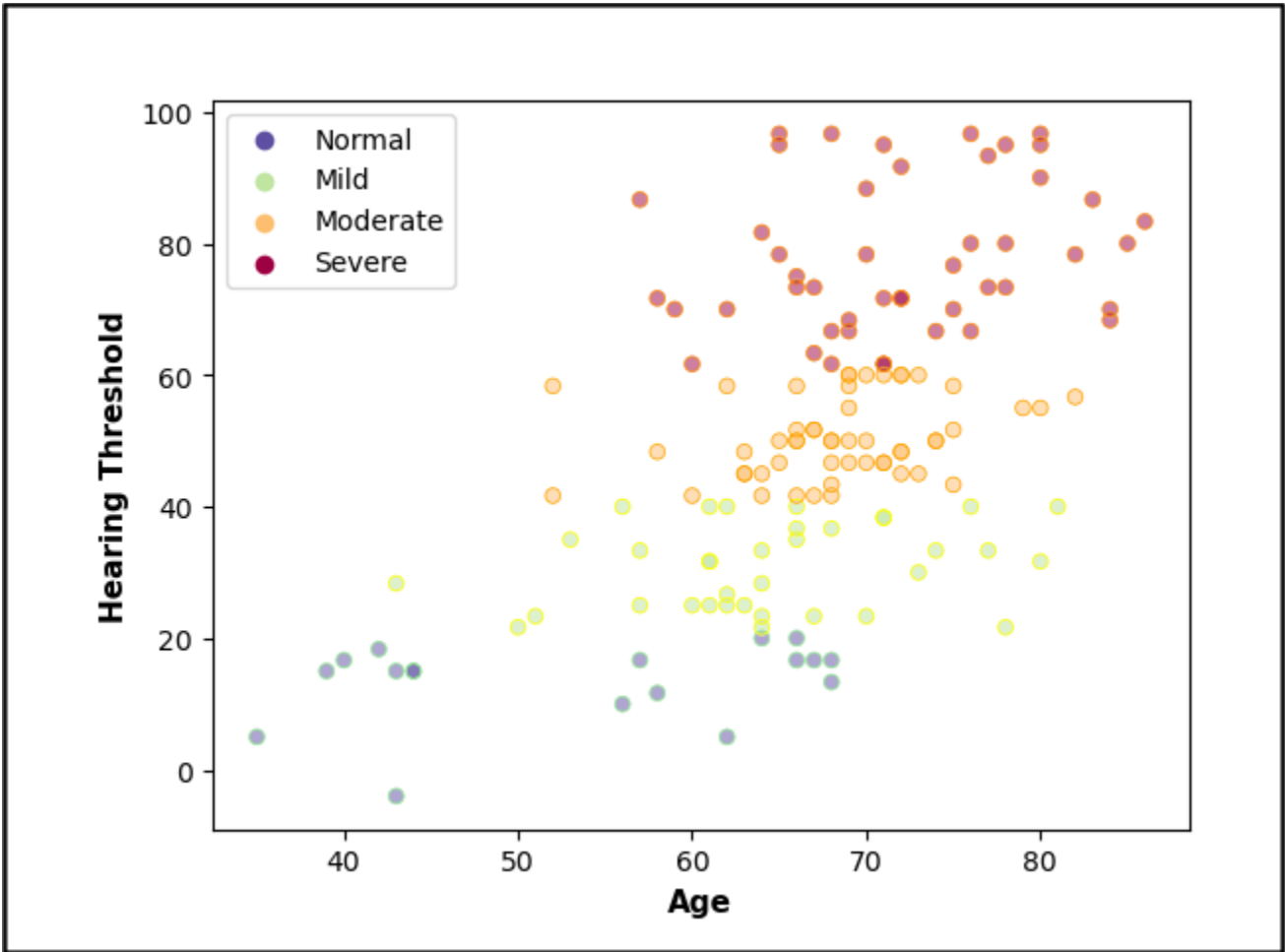

Figure 4.3. A scatterplot showing the relationship between Age and PTA Hearing Thresholds in Decibels (dB). As age increases, PTA hearing thresholds also increase in the AudCog cohort. Specific gradations of hearing loss severity are indicated by the colours blue (normal), green (mild hearing loss), orange (moderate hearing loss) and red (severe hearing loss).

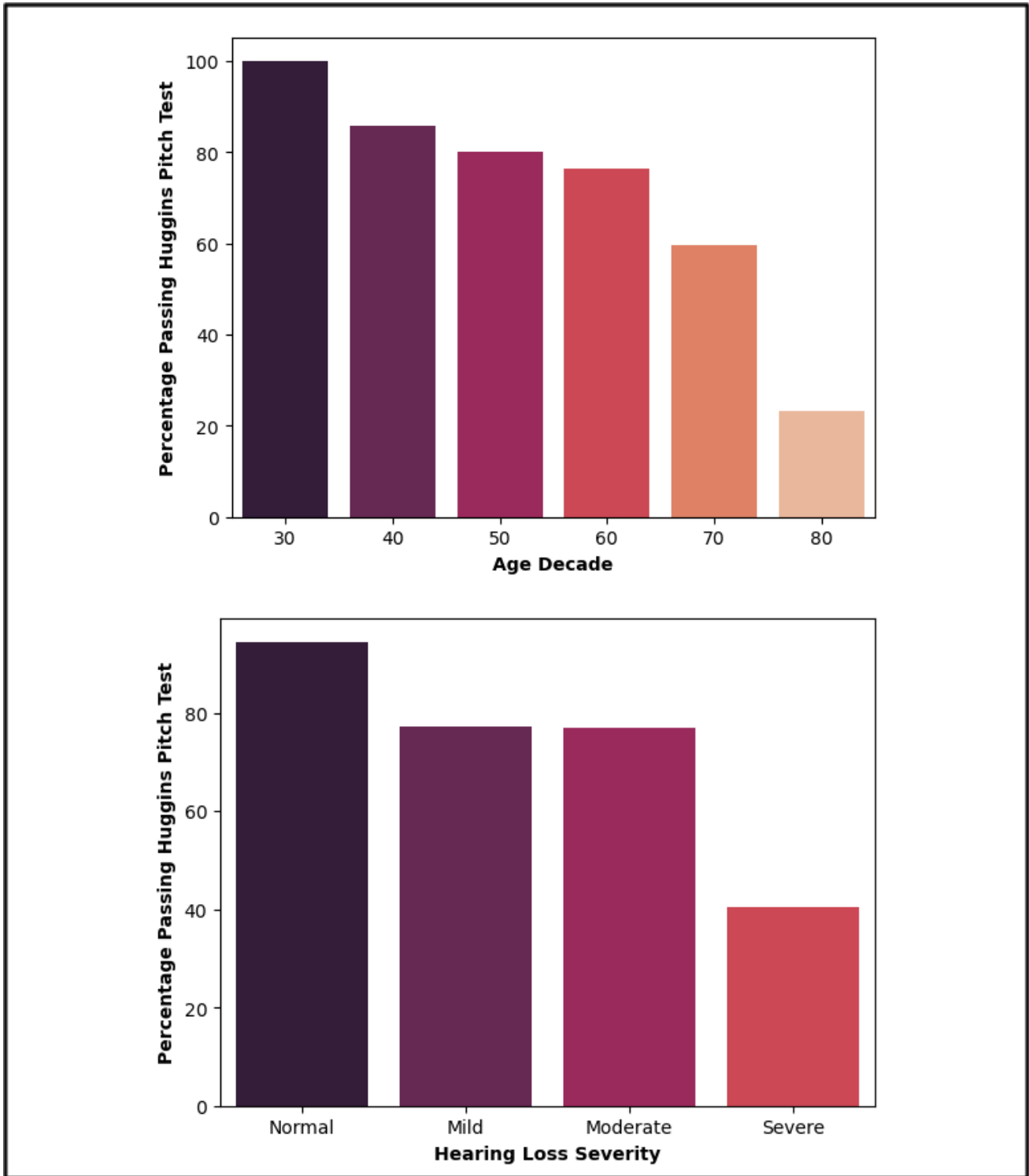

Figure 4.4. *Percentage of people passing the Huggins Pitch test.* This bar chart shows the percentage of people passing the test per decade (x-axis) (top image) and the bottom image shows this percentage by hearing loss severity.

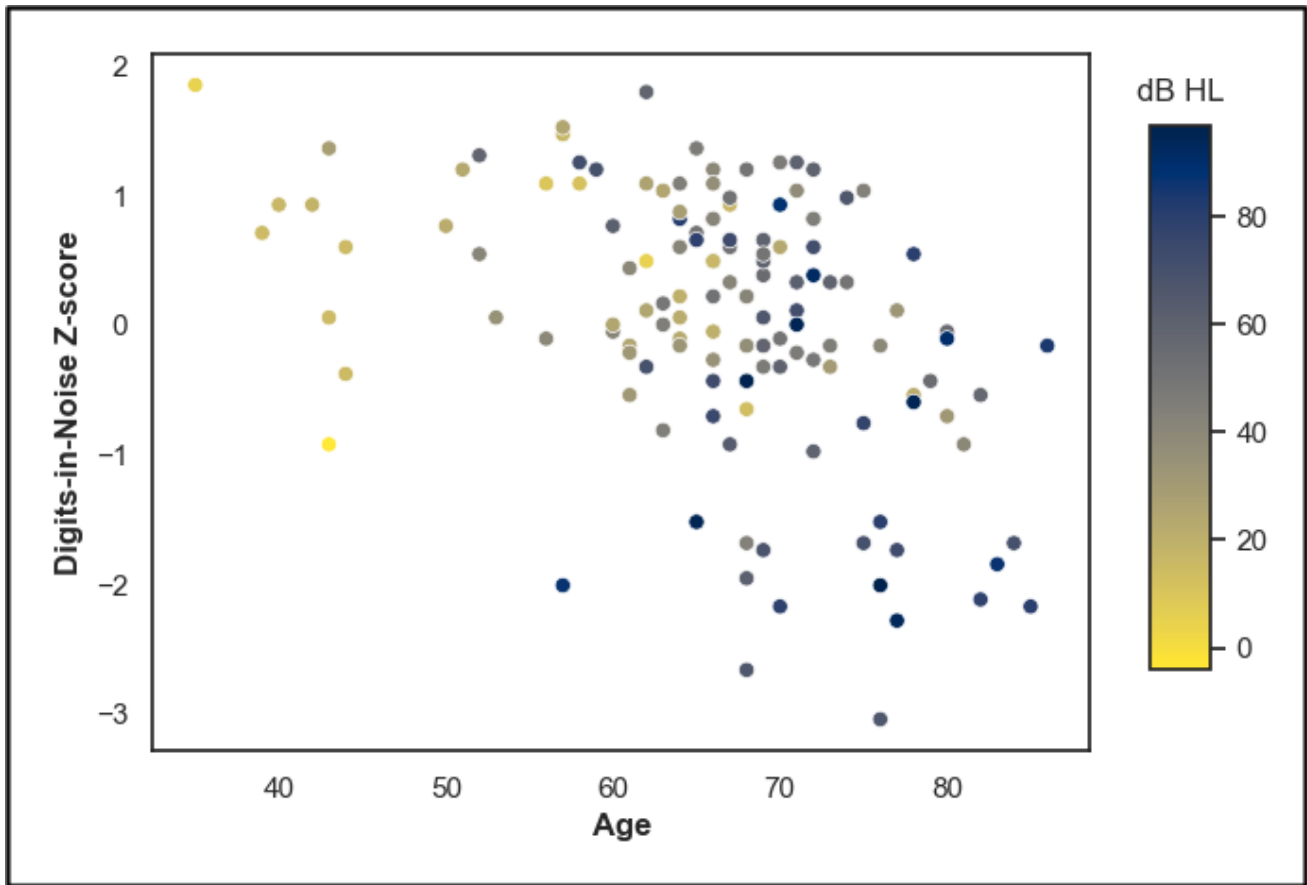

Figure 4.5. Relationship between performance on the Digits-in-Noise (DiN) test and Age. As age increases, DiN performance worsens ($R = -0.24$ [-0.4, -0.08], $p < 0.005$, $BF = 2.39$). DiN z-scores are closely related to PTA thresholds (dB HL) as indicated by the colour of the individual data points. Yellow values indicate normal or mild hearing loss and dark blue values suggest more severe hearing loss.

4.3.3. *Best predictors of Speech-in-Noise perception*

The DiN and SiB tasks differed in the duration of the stimuli and the response time for each trial. SiB matching times (mean = 9.1 seconds) were significantly longer than DiN matching times by 7.7 (± 1.6) seconds ($t = 9.5$, $p < 0.001$, $BF > 10000$). Therefore, I hypothesised that auditory memory would better predict SiB performance rather than DiN. In order to investigate this, several linear models were created, using Age, PTA scores, AuM precision for frequency, AuM precision for AM rate and GMSI scores, to predict DiN and SiB thresholds. All of these models showed statistical significance in linear regression, therefore each model was compared using BIC to determine the 'best' model. A difference of above 2 between BIC values for models constitutes 'positive' evidence in favour of the model with the lower score. Table 4.1 shows models and their respective scores for each response variable. A linear model with Age and PTA scores best predicted DiN thresholds whereas a model with Age, PTA and AuM for AM rate precision best predicted SiB thresholds.

4.3.4. *Structural Equation Modelling of SiN ability*

The path model for the structural equation models and their coefficients is shown in figure 4.6. Structural Equation Modelling revealed a robust fit between the proposed model and the observed data and that they were not significantly different ($\chi^2 = 7.4$, $p = 0.408$). The Comparative Fit Index (CFI), a measure that compares the specified model with a null model, yielded a value of 0.999. Typically, a CFI value greater than 0.95 is considered indicative of an excellent fit, suggesting the model's strong representation of the relationships within the data. Similarly, the Tucker-Lewis Index (TLI), which accounts for model complexity, registered a value of 0.997. TLI values above 0.95 are also seen as indicators of a good fit, further attesting to the model's adequacy. The Root Mean Square Error of Approximation (RMSEA), which provides insights into the discrepancy between the observed data and the hypothesised model per degree of freedom, reported a value of 0.014. RMSEA values less than 0.05 are often interpreted as a close fit and my value lies well within this range.

Table 4.1

| Model | BIC Score | |
|--------------------------------------|------------|------------|
| | <i>DiN</i> | <i>SiB</i> |
| Age + PTA | 399.6* | 295.7 |
| Age + AuM (F) | 403.9 | 294.5 |
| Age + AuM (F) + GMSI | 408.2 | 299.4 |
| Age + AuM (A) | 405.1 | 294.0 |
| Age + PTA + AuM (F) | 401.3 | 292.6 |
| Age + PTA + AuM (F) + GMSI | 405.9 | 297.5 |
| Age + PTA + AuM (A) | 401.8 | 290.9* |
| Age + AuM (F) + AuM (A) | 407.7 | 294.2 |
| Age + AuM (F) + AuM (A) + GMSI | 412.0 | 299.2 |
| Age + PTA + AuM (F) + AuM (A) | 404.8 | 291.5 |
| Age + PTA + AuM (F) + AuM (A) + GMSI | 409.4 | 296.4 |

The various linear models used to predict Digits-in-Noise (DiN) scores and Speech-in-Babble (SiB) scores. Bayesian Information Criterion (BIC) scores are shown alongside each model. The lowest score indicates the best suited model for each test (indicated by an asterisk).

PTA - Pure Tone Audiogram scores, AuM (F) - Auditory Memory precision for Frequency, AuM (A) - Auditory Memory precision for AM Rate, GMSI - Goldsmiths Musical Sophistication Index score.

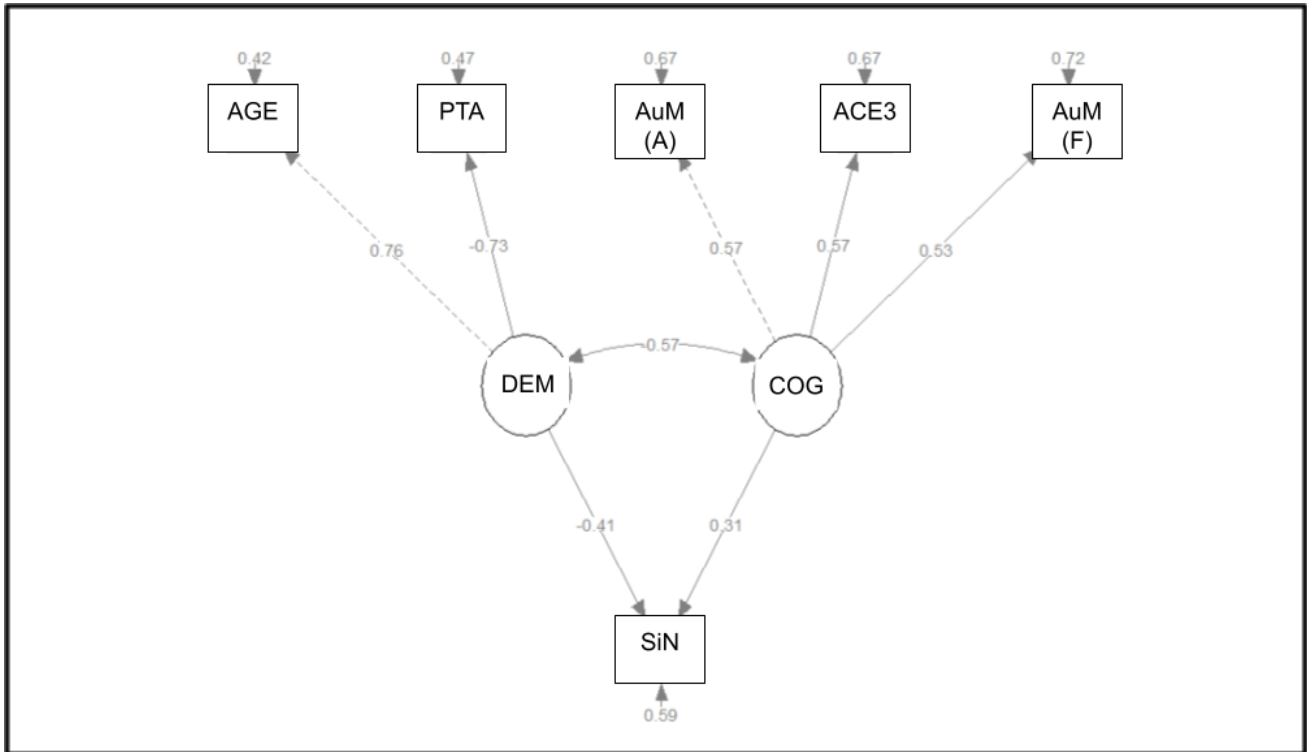

Figure 4.6. *Structural Equation Model of Hearing and Cognitive Abilities.* The figure presents a path diagram representing the relationships between latent and observed variables related to hearing and cognitive abilities (including auditory cognitive measures). The ovals in the diagrams represent the 'Latent Variables' for Demographic (DEM) Factors affecting hearing and Cognitive (COG) Ability. The observed variables are indicated by rectangles. These are the measure variables that inform the latent constructs. Solid arrows indicate paths with direct effects and the values on these paths represent standardised coefficients showing the strength and direction of the relationships. The dotted arrows denote covariances or correlations between variables suggesting an association rather than a direct influence.

PTA - Pure Tone Audiogram, AuM (A) - Auditory Memory for Amplitude Modulation rate, ACE3 - Addenbrooke's Cognitive Examination (Third Edition), AuM (F) - Auditory Memory for Frequency, DEM - Demographic factors affecting hearing, COG - Cognitive factors affecting hearing, SiN - Speech-in-noise perception ability.

4.4. Discussion

This study highlights the importance of understanding the type of SiN perception measures used when assessing central hearing. It shows that although the two different measures used were related to peripheral hearing and age, cognitive domains such as memory may become relevant when the duration of stimuli and the interval between the stimuli and the participant response are long (greater than 10 seconds). Measuring both these abilities then allows one to create cognitive models that can be applied and interrogated in hearing and cognitive disorders.

4.4.1. *When does auditory memory support speech-in-noise perception?*

There are a myriad of SiN perception tests which are used in research and some clinical settings with different characteristics. These have shown a differential involvement of auditory memory when predicting SiN ability. Phonological working memory measures such as the reading span have been shown to have an additional predictive value in addition to peripheral hearing measures (Akeroyd, 2008). The reading span requires the processing and storage of a number of sentences and recall of the last word of each sentence, which requires memory over tens of seconds. SiN ability was commonly measured in these tasks using sentences in noise perception which may require processing over a length of time where working memory measures and SiN ability would be expected to correlate. This was similar to the SiB task used in this chapter.

Some studies have noted that auditory memory may only become relevant in older individuals and those with hearing impairment (Füllgrabe and Rosen, 2016). The reasons for this are unclear but may be related to greater resources from working memory being required for understanding sentences in noisy backgrounds when perceptual machinery is partly degenerated. This may have been a reason why the AuM task, based on resource allocation models, related better to the SiB than DiN task thresholds. It is also possible that as age-related changes in the auditory system lessen perceptual fidelity, auditory memory resources are devoted to reinstate SiN perception at shorter and shorter time scales. Although this question was not directly probed in this study, it lays the framework for further exploration of these ideas,

especially as inclusion of PTA thresholds in a given model improved the models performance as indicated by lower BIC scores.

4.4.2. Duration of speech-in-perception tests affects relationship with auditory memory measures

This study suggests that the choice of paradigm used to test SiN ability may determine if auditory memory is needed for the task. Whilst the best model for predicting DiN scores included age and PTA scores as predictors, the best model that predicted SiB scores required the addition of AuM precision for AM rate. The latter finding is congruent with my previous finding about the relationship between SiB performance and AuM but the much larger sample size of this study and diverse participant characteristics allows for a nuanced analysis of the data (Lad et al., 2020). That study suggested a better relationship between SiB and AuM precision for frequency but the smaller sample size did not allow for the inclusion of covariates to provide an accurate assessment of the data. These data suggest that during sentence-in-noise perception, memory over a period of tens of seconds for AM stimuli may be a crucial element that allows individuals to communicate successfully.

Despite DiN scores being the best predicted by age and PTA scores only, the second best model was that same as the best predictor model for SiB scores. This suggests that AuM may still be important for SiN perception at shorter time intervals (the stimulus in the DiN task was presented over three seconds). Further work is necessary to evaluate whether similar results would be found when SiN is tested with word-in-noise tasks where the stimuli only consist of a single word that must be correctly perceived on a noisy background. At longer time durations (above ten seconds), for the SiB task, other models that were close to the best model consisting of age, PTA scores and AuM precision for AM rate either included AuM precision for frequency instead or included both measures suggesting that stimulus independent mechanisms of AuM memory be relevant to SiN perception. This suggests a greater involvement of cognitive factors for communicating in noisy environments. The structural equation model further highlighted the importance of a range of cognitive measures in successful SiN perception, such as global cognitive scores and AuM for frequency and AM rate.

4.4.3. *What is auditory memory precision for AM rate?*

The similarities shared by AM white noise stimuli and clear speech in natural conversation may explain the significant relationships between AuM for these stimuli and those measuring SiN perception ability. Both clean speech signals and AM noise have temporal fluctuations in their amplitude envelopes (Goswami, 2019). These fluctuations in speech arise due to the natural rhythm, stress patterns, and syllable structure of spoken language. In AM noise, these fluctuations are artificially imposed by modulating the amplitude of the noise over time and can be used to study how the auditory system processes and encodes temporal information in speech, even in the absence of background noise. The modulation patterns in AM noise can be designed to resemble the natural modulation patterns found in speech signals by manipulating the modulation rate and depth. This allows for the study of the auditory system's sensitivity to modulation patterns in speech. Listening to clean speech stimuli and AM noise both involve cognitive processing. In the case of clean speech, listeners need to decode the linguistic information and understand the message being conveyed. With AM noise, listeners need to process and track the temporal fluctuations of the signal. In both cases, cognitive resources such as attention and working memory are engaged, allowing one to study the role of cognitive factors in auditory processing in noise.

The AuM precision task for AM rate may be able to capture an individual's general ability to remember speech-like sounds over several seconds, which may be more relevant to SiN perception ability than memory for frequency. Holding frequency of a sound over time, a property related to the source of a sound, may not confer an advantage for speech intelligibility over memory for AM rate, that is related to temporal fluctuations in it and may be relevant to speech factors that are independent of a speaker. The results for AuM trials for frequency may also be confounded by an individual's ability to rehearse or remember the pitch of the stimulus which may be dependent on factors such as musical sophistication. However, the analysis with the addition of this measure also did not improve the fit of the model with AuM frequency. There is evidence that AM phase relationships are important in speech rhythm perception, particularly those sounds with strong onsets like 'stress syllables' that produce large amplitude fluctuations in the speech envelope (Leong et al., 2014). Speech also becomes unintelligible if these important fluctuations are removed (Doelling et al., 2014). The AM rates used in the experimental task were between 5 and 15 Hz which mirrors the rates present in human speech, which may have contributed to its success. The AuM precision metric for each individual was a

summary statistic taking into account errors across the whole experiment; further work is needed to dissociate if specific elements of the task (e.g. best precision at any point in the task) may better relate to SiN ability.

There are significant differences between speech stimuli and AM noise that must be noted as well. Speech stimuli contain linguistic information, phonetic features, and specific spectral characteristics that are not present in AM white noise. One of the differences between the DiN and SiB tasks were the use of numbers in one and words making up sentences in the other. There is evidence to suggest that numbers have lower semantic complexity than words. Semantic complexity refers to the degree of meaning or information that a word or concept conveys. A study conducted in which participants were asked to rate the meaningfulness of a set of words and numbers found that words were rated as more meaningful than numbers, suggesting that words have higher semantic complexity than numbers (Paivio et al., 1968). However, the fact that the non-speech stimuli used in the AuM tasks were able to capture relationships with verbal SiN tasks show that there may be general auditory cognitive abilities that are common to both constructs. This may be advantageous when developing tests for hearing and cognitive disorders for diverse populations.

4.4.4. Auditory Model of SiN Perception

There is great importance in understanding the complex relationship between peripheral hearing processes, cognitive ability and SiN perception (Slade et al., 2020). Poor peripheral hearing is associated with greater rates of cognitive decline and poor cognitive abilities like working memory are also important determinants of SiN perception. I therefore, created a path model reflecting these factors to study the contributions of demographic and cognitive factors in SiN perception ability. This was a simple model that was meant to reflect the distinct peripheral and central contributions to SiN perception. The model showed a very strong fit between the proposed parameters and the actual ones derived from the AudCog study when two latent variables reflecting each of them were created. SiN perception declines with age but is also more pronounced when cognition is low, therefore the model seemed to capture this interaction sufficiently (Moore et al., 2014).

Although this model suggests the most likely strengths of association, one must keep in mind that the relationships may be more complex than the simple path model that was created and that the relationships could also be non-linear. For example, studies have shown that SiN perception ability may decline at faster rates at older ages (Pronk et al., 2013). Another example of the non-linear relationship between poor PTA scores and SiN perception occurs at the individual level where although an auditory signal is less audible, due to its volume, it may still be intelligible to listeners but there may come a point when a tipping point is reached so that the auditory signal is undecipherable. Age also has direct negative effects on cognition, which was not described in the path model. Although this omission was due to pilot studies showing a weaker association of age and the AuM metrics, further work could compare various models using model comparison techniques. The model also does not capture any top-down effects with paths from cognitive ability or SiN perception ability to peripheral hearing, which are active to some degree (Johnson et al., 2021; Kocagoncu et al., 2021).

4.4.5. *Limitations and future directions*

The effects of ageing on the auditory system are difficult to study as there are multiple factors which can influence hearing beyond those used in this study. Firstly, there is inherent variability in genetics and the environment that can affect hearing from the peripheral to the central areas of the auditory system (Gates and Mills, 2005). Humans are also exposed to varying degrees of noise, either continuously or with occasional episodes of very high decibel trauma from loud music or environmental exposure and drugs that are toxic. Both of these factors can inner ear and cognitive function and in turn auditory performance. Although this study assessed factors that are evidenced to have a large effect on SiN perception ability, further work needs to consider elements such as genetics, environmental noise exposure and socioeconomic factors as predictor variables (Tsimpida et al., 2019).

One of the other limitations of this study is that the tests were those that were selected and refined from a range of potential ones described in the literature for studying SiN perception. The DiN task and the SiB task capture two ends of stimuli that could be used in terms of semantics, background masker and duration of stimuli. It would be interesting to study whether word-in-noise perception ability and DiN performance are modelled similarly by the variables used in this study (Wilson et al., 2007). As with more behavioural studies, despite the relatively

larger sample size, there were only around 150 participants enrolled. A larger sample size would allow methods such as cross-validation and a separate test sample to be used in order to accurately assess the predictability of the linear models used in this chapter.

A pertinent future direction involves measurement of presbycusis due to neural factors in the peripheral and central auditory pathways, such as the brainstem (Plack et al., 2014). Peripheral hearing apparatus may contribute to the perception of temporal fine structure of speech and age-related hearing loss has been shown to affect this ability (Schneider and Pichora-Fuller, 2001). Secondly, there are emerging tests for hidden hearing loss where individuals have hearing difficulties with normal audiograms. Researchers and clinicians have been exploring alternative testing methods to assess this ability and SiN perception, such as auditory brainstem response tests and envelope or frequency following response tests. These metrics are affected by abnormal temporal coding of sound which may be particularly relevant for AM sounds used in the AuM precision task in this study. Extended high-frequency audiometry has also been shown to be a contributor to effective SiN perception, however, special equipment is necessary to measure these reliably (Motlagh Zadeh et al., 2019). Future work needs to consider all of these methods in order to take a comprehensive approach to objective hearing assessment.

5. Speech-in-Noise Perception and Auditory Memory in Alzheimer's Disease Dementia

5.1. Introduction

Poor scores on central hearing measures, like SiN perception ability, are related to an increased risk of dementia (Stevenson et al., 2022). The effect remains after controlling for scores on peripheral hearing, such as from the PTA (Gates et al., 2008). Research has also identified associations with central auditory measures and risk of specific dementias like AD dementia. Raised levels of *in-vivo* neurodegenerative fluid biomarkers like pTau-181, a biochemical marker that predicts conversion to AD dementia from MCI-AD with a very high degree of accuracy, are present in people with low SiN perception ability scores (Palmqvist et al., 2021; Tuwaig et al., 2017). This suggests a potential link between central hearing and AD neuropathology (Griffiths et al., 2020). There is also evidence showing greater atrophy in the medial temporal lobe, rather than the auditory neocortex, in people who have severe hearing loss measured years before their brain scan (Lin et al., 2014). Medial temporal lobe regions such as the entorhinal cortex and hippocampus are one of the earliest sites affected in AD (Braak and Braak, 1991). Therefore, it is plausible that auditory cognitive mechanisms that involve these regions are preferentially affected in AD dementia.

The study described in this chapter examines whether SiN ability and one of its key determinants, AuM, is impaired across the AD continuum. The previous chapter showed how AuM for AM rate was an important predictor variable when SiN perception occurred at long durations (more than 10 seconds). AuM over this timeframe has previously been shown to involve the hippocampus, a key brain structure for long-term memory (Kumar et al., 2021, 2016). As this region is usually affected in AD dementia, it follows that AuM may be impaired and there may be group-level differences in patient populations depending on the severity of their cognitive impairment due to AD. This chapter also assesses how SiN ability, measured as a composite of DiN and SiB ability, and AuM can be used to classify the particular group a person belongs to depending on demographic and auditory cognitive scores.

5.1.1. *Speech-in-Noise Tests in Alzheimer's disease*

Poor baseline central auditory abilities increase the future risk of all-cause dementia (Stevenson et al., 2022). In a large longitudinal study with more than 80,000 participants from the UK Biobank, Stevenson et al. showed that 'insufficient' or 'poor' hearing ability based on a central hearing measure was associated with a 61% (hazard ratio = 1.61, 95% CI 1.41-1.84) increased risk of developing dementia compared to 'normal' hearing metrics. One of the strengths of this study was the inclusion of a mediation analysis with factors that could potentially act as confounds for this relationship such as depressive symptoms and social isolation. These factors only explained between 2 to 6% of the relationship, which was deemed insufficient to account for the main findings. Other factors that have been shown to affect hearing ability such as social deprivation, general health and educational status were also adjusted for in statistical analysis (Tsimpida et al., 2019). However, a diagnosis of dementia was only gleaned from hospital in-patient and death records which could have introduced a misclassification bias. The study did not include information on peripheral hearing such as PTA thresholds.

The test used in this study was similar to the DiN task used in the AudCog study but without dichotic phase differences between the headphone channels. Previous work, linking central hearing deficits to dementia risk, has used dichotic stimuli where auditory sounds are presented in each ear separately, but at the same time (Gates et al., 2008; Utoomprurkporn et al., 2020). Although these tasks have shown great promise as potential markers of cognitive impairment in AD dementia, the mechanistic explanations for these in-terms of the neural substrates involved are less clear. The tests are susceptible to attentional confounding and ear advantage, which can vary from person to person. The tests have also varied in the presenting stimulus, numbers or sentences, and even when composite scores have been established they have not studied cognitive domains that might be implicated in the AD pathophysiology making it difficult to understand them further.

A gap in the literature exists when translating these measures to the level of the individual. Commonly, several individual measures are assessed in isolation when their combination may perhaps be more informative. For example, just as neuropsychological normative data are adjusted based on premorbid abilities, using a statistical adjustment for central auditory abilities may be needed when trying to study the elements of auditory cognition that may be most

informative about AD dementia. In the next section, I describe an approach to study SiN perception ability by taking into account AuM abilities that activate brain structures implicated in AD dementia.

5.1.2. Auditory Cognition via the Medial Temporal Lobe in Alzheimer's Disease

SiN perception and phonological working memory are closely related in older individuals and when there is peripheral hearing loss present (Akeroyd, 2008). Although this study summarised results from various pieces of work using the reading span as a test of working memory, others have shown that the relationship is robust despite variations in the working memory measures used (Souza and Arehart, 2015). I have previously shown that auditory memory tests below the level of speech have a similar relationship with SiN ability tested using multi-talker babble (Lad et al., 2020). The work in the previous chapter also replicates this finding and clarifies that the strength of the relationship is stronger for AuM for AM sounds. These studies, collectively, highlight the importance of cognitive domains, like memory, in SiN perception in older adults.

Auditory memory is an attractive cognitive mechanism for the link between poor SiN perception ability and cognitive impairment in AD dementia due to its neuroanatomical substrates. Previous work from our laboratory has suggested that auditory memory for several seconds is potentially mediated by medial temporal lobe structures. The maintenance of tones, without interference, for more than 3 seconds activates the hippocampus with fMRI and shows low-frequency oscillatory activity in the region with iEEG (Kumar et al., 2021, 2016). Interestingly, the fMRI study did also show greater activation in the hippocampus for longer maintenance periods potentially reflecting long-term memory resources being utilised. The maintenance periods for this task lasted for up to 16 seconds. The AuM task developed for the previous chapter takes advantage of this feature as matching periods may last from 3 seconds to even 20 seconds as it is self-paced.

The two objectives of this study were to:

1. Test whether SiN ability and AuM shows group-level differences between healthy and patient groups

2. Test the classification accuracy of SiN ability and AuM for AD dementia, as compared to other auditory measures.

5.2. Methods

This study was approved by the Oxford C NHS Research Ethics Committee - 21/SC/0139 - and sponsored by the Newcastle Hospitals NHS Foundation Trust.

5.2.1. *Participants*

143 cognitively healthy participants (91 female) were recruited into the AudCog study from March 2022 until Aug 2023. These participants provided data for the previous chapter that forms the results for the 'Cognitively Normal' cohort used to compare patient populations in this study.

The patient population consisted of three subgroups described in Table 5.1:

1. People with Limbic Encephalitis (LE): This group included 7 people who had one episode of autoimmune limbic encephalitis affecting the medial temporal lobes and had recovered after therapy. Only participants with a uniform syndrome of episodic memory dysfunction and seizures were recruited to this study. 5 out of the 7 patients had positive LGI-1 antibodies in serum. Others had clinical data, such as the presence of FBDS, suggestive of LGI-1 positivity but only had VGKC antibodies taken as the former was not clinically available when they were initially diagnosed (Sr et al., 2011).
2. People with MCI-AD: 10 people were recruited from the Neurology Cognitive Disorders clinic at the Newcastle Hospitals NHS Foundation Trust and the Old Age Psychiatry Memory Assessment and Management Service and Cumbria, Northumbria, Tyne & Wear NHS Foundation Trust. Patients were diagnosed by a senior clinician according to the latest clinical criteria (Jack et al., 2018).
3. People with AD Dementia: 15 patients were recruited from the same sources as those with MCI-AD and were diagnosed using the same consensus criteria. 5 patients had a CSF biochemical profile consistent with AD Dementia where the A β 42/A β 40 ratio was below 0.065 and the pTau-181 level was above 57 pg/mL.

As part of the recruitment for the AudCog study, a patient who had a diagnosis of AD dementia at the time of participation but was subsequently diagnosed with a Functional Cognitive Disorder (FCD) was also included in the dataset. This participant's data was used to test the model that was developed for classifying the participant groups. The participant was a 68 year-old gentleman who had a 10 year-history of fluctuating memory problems that impacted his life. He was unable to drive and retired from working as a tradesman. He was the sole informant for his difficulties and recounted problems remembering appointments, important dates and performing household chores. The severity of these problems would fluctuate on a day-to-day basis. He scored 74/100 on the ACE-III (sub-scores: Attention 10/18, Memory 14/26, Fluency 10/14, Language 20/24, Visuospatial 14/16). The patient showed a variable ability to recall events to various healthcare professionals and research staff. A friend of the participant also subsequently revealed that his cognitive symptoms may not be as severe as that described by the participant particularly due to his level of function. This led to a re-diagnosis of the patient's condition.

5.2.2. Auditory Testing

All but 4 participants underwent testing at the Auditory Laboratory at Newcastle University. Auditory testing was conducted in a soundproof room. This involved measuring PTA thresholds and the DiN, SiB and AuM tasks in a randomised order. 4 patients with AD Dementia were tested in their homes in a quiet room without distractions using a laptop, external soundcard and Sennheiser headphones. All participants with AD dementia required Dr Lad to use the computer mouse to select options on the screen for auditory testing as well as to facilitate the questions being answered for the GMSI questionnaire. Each participant had a spouse or carer who knew the patient before their diagnosis of dementia and was present with them who was able to support filling out these questionnaires. Participants filled out the questionnaire to reflect their musical sophistication before a diagnosis of dementia.

5.2.3. *Statistical Analysis*

Metrics for PTA hearing thresholds, DiN, SiB, AuM precision for AM rate and frequency, and SiN were produced for each group of participants and compared using student's t-tests. The composite score for SiN was created by taking the difference in performance metrics of the DiN and SiB task. This was then converted to z-scores like the other variables. In order to test the accuracy of previous models in predicting group diagnosis, logistic regression was employed using the various models below and classification accuracy was tested using receiver operator curves (ROC) that produced an Area Under the Curve (AUC) metric. The parameters that were trained from this model were then used to assess the group classification of a patient with functional cognitive disorder as a case study. Python 3.10 was used on Jupyter notebooks for all analysis with the SciPy, Scikit-learn and Pingouin packages for statistical analysis.

Table 5.1 - Baseline patient characteristics

| | <u>CN</u> | <u>LE</u> | <u>MCI-AD</u> | <u>AD Dementia</u> |
|----------------------------------|------------------|------------------|----------------------|---------------------------|
| Count (n) | 143 | 6 | 10 | 15 |
| Age (years) | 66.7 (9.6) | 70.2 (7.2) | 72.2 (7.2) | 74.9 (4.8) |
| Gender (%) | | | | |
| <i>Male</i> | 36% | 67% | 40% | 57% |
| <i>Female</i> | 64% | 33% | 60% | 43% |
| Education (most frequent) | 3 | 1 | 3 | 1 |
| Cognitive Scores | | | | |
| <i>ACE-III (/100)</i> | 96.3 (3.0) | 89.8 (4.8) | 85.3 (6.5) | 71.2 (9.6) |
| <i>Memory (/26)</i> | 23.9 (2.4) | 20.0 (1.7) | 17.4 (3.6) | 10.6 (5.3) |
| <i>Language (/26)</i> | 25.9 (0.4) | 25.7 (0.8) | 25.4 (0.9) | 25 (2.0) |
| <i>GMSI (/)</i> | 152.2 (38.5) | 124 (15.8) | 123.2 (28.3) | 121.8 (22.5) |

Baseline characteristics for all participant groups.

ACE-3- Addenbrooke's Cognitive Examination (Third Edition), GMSI- Goldsmiths Musical Sophistication Index, CN- Cognitively Normal, LE- Limbic Encephalitis, MCI-AD- Mild Cognitive Impairment due to Alzheimer's Disease. Variability for numerical group level statistics is indicated as a standard deviation in parentheses.

5.3. Results

5.3.1. *Group-level Differences in Auditory Cognitive Metrics*

Table 5.2 shows the group-level differences in auditory metrics including peripheral and central measures between the 'Cognitively Normal', 'LE', 'MCI-AD' and 'AD Dementia' groups. Group-level summary statistics showed that all participant sub-groups had a mean hearing loss level within the 'moderate' hearing loss range. 'Cognitively normal' participants had mean PTA thresholds of 49.9 (± 23.8) dB HL, people with LE a mean threshold of 53.6 (± 13.2) dB HL, people with MCI-AD a mean threshold of 55.8 (± 21.0) dB HL and people with LE a mean threshold of 64.2 (± 20.6) dB HL.

The Huggins pitch perception task, described in Chapter 2, was implemented as another test of auditory cognition. There were 6 trials in the task and a pass required an individual to perceive at least 5 different stimuli across all the trials. For each participant, a value of 1 was given if they passed the task and a 0 if they did not. A mean value was obtained for each patient group. 'Cognitively normal' participants, LE and MCI-AD participants were more likely to pass the Huggins pitch perception task with scores of 0.67 (± 0.47), 0.83 (± 0.41) and 0.60 (± 0.52). People with a diagnosis of AD Dementia were more likely to fail the test with a mean score of 0.07 (± 0.27).

Table 5.2 - Group-level Auditory Metrics for Patients

| | <u>CN</u> | <u>LE</u> | <u>MCI-AD</u> | <u>AD Dementia</u> |
|----------------------|------------------|------------------|----------------------|---------------------------|
| PTA (dB HL) | 49.9 (23.8) | 53.6 (13.2) | 55.8 (21.0) | 64.2 (20.6) |
| Huggins (/1) | 0.67 (0.47) | 0.83 (0.41) | 0.60 (0.52) | 0.07* (0.27) |
| DiN (dB) | 5.19 (4.48) | 7.17 (1.31) | 5.70 (1.86) | 1.58* (3.08) |
| SiB (dB) | 0.32 (3.67) | -1.93 (4.19) | -1.62 (3.32) | -10.9* (8.50) |
| AuM (A) (a.u) | 0.08 (0.03) | 0.06 (0.04) | 0.06 (0.02) | 0.04* (0.02) |
| AuM (F) (a.u) | 0.28 (0.22) | 0.16 (0.14) | 0.14 (0.08) | 0.07* (0.06) |

Baseline characteristics for all participants with some form of cognitive impairment.

PTA - Pure Tone Audiogram, DiN- Digits-in-Noise task, SiB- Speech-in-Babble task, AuM (A) - Auditory Memory Precision for AM rate, AuM (F) - Auditory Memory Precision for Frequency, CN - Cognitively Normal, LE - Limbic Encephalitis, MCI-AD - Mild Cognitive Impairment due to Alzheimer’s Disease, dB HL - Decibels Hearing Loss, a.u - arbitrary units. Variability for numerical group level statistics is indicated as a standard deviation in parentheses. Asterisks indicate significant differences from other groups.

There were significant group-level differences for people with AD dementia and those without dementia for the DiN task where 'Cognitively Normal', 'LE' and 'MCI-AD' participants had a mean SNR score of 5.19 (± 4.48), 7.17 (± 1.31) and 5.70 (± 1.86), whereas those with AD dementia had a mean score of 1.58 (± 3.08). Similarly, absolute SNR values for the SiB task were much lower for the AD dementia group at -10.9 (± 8.50) whereas people with MCI-AD, at -1.62 (± 3.32), and LE, at -1.93 (± 4.19), were slightly lower than 'Cognitively Normal' participants at 0.32 (± 3.67). Both metrics of AuM showed a steady decline from 'Cognitively Normal' participants to those with MCI-AD to LE to AD Dementia. For AuM precision for frequency, values for the respective groups in the above order were 0.28 (± 0.22), 0.16 (± 0.14), 0.14 (± 0.08) and 0.07 (± 0.06). For AuM precision for AM rate, values for the respective groups in the above order were 0.08 (± 0.03), 0.06 (± 0.04), 0.06 (± 0.02) and 0.04 (± 0.02) (Figure 5.1). *Post-hoc* analysis showed that AuM for AM rate showed a significant relationship with total ACE-III scores after adjusting for age and educational status ($R^2 = 0.34$, $p < 0.001$) as did AuM for frequency ($R^2 = 0.28$, $p < 0.001$).

5.3.2. Classification Accuracy of SiN Ability

Unadjusted auditory metrics showed varying levels of differences between the participant groups. Therefore, the linear models used in the previous chapter were used to assess the best combination of peripheral and central auditory measures that allowed accurate separation of these groups using logistic regression. Table 5.3 shows the predictive accuracy of various logistic regression models in classifying the patient category by using the AUC performance measure. The table shows how a combination of age, PTA thresholds, AuM for AM rate and the SiN composite score allow the best separation of all the groups.

Upon using the model to predict the classification of the individual with FCD, based on the selected features, the model classified them as 'Cognitively Normal' with a high likelihood of approximately 97.05%.

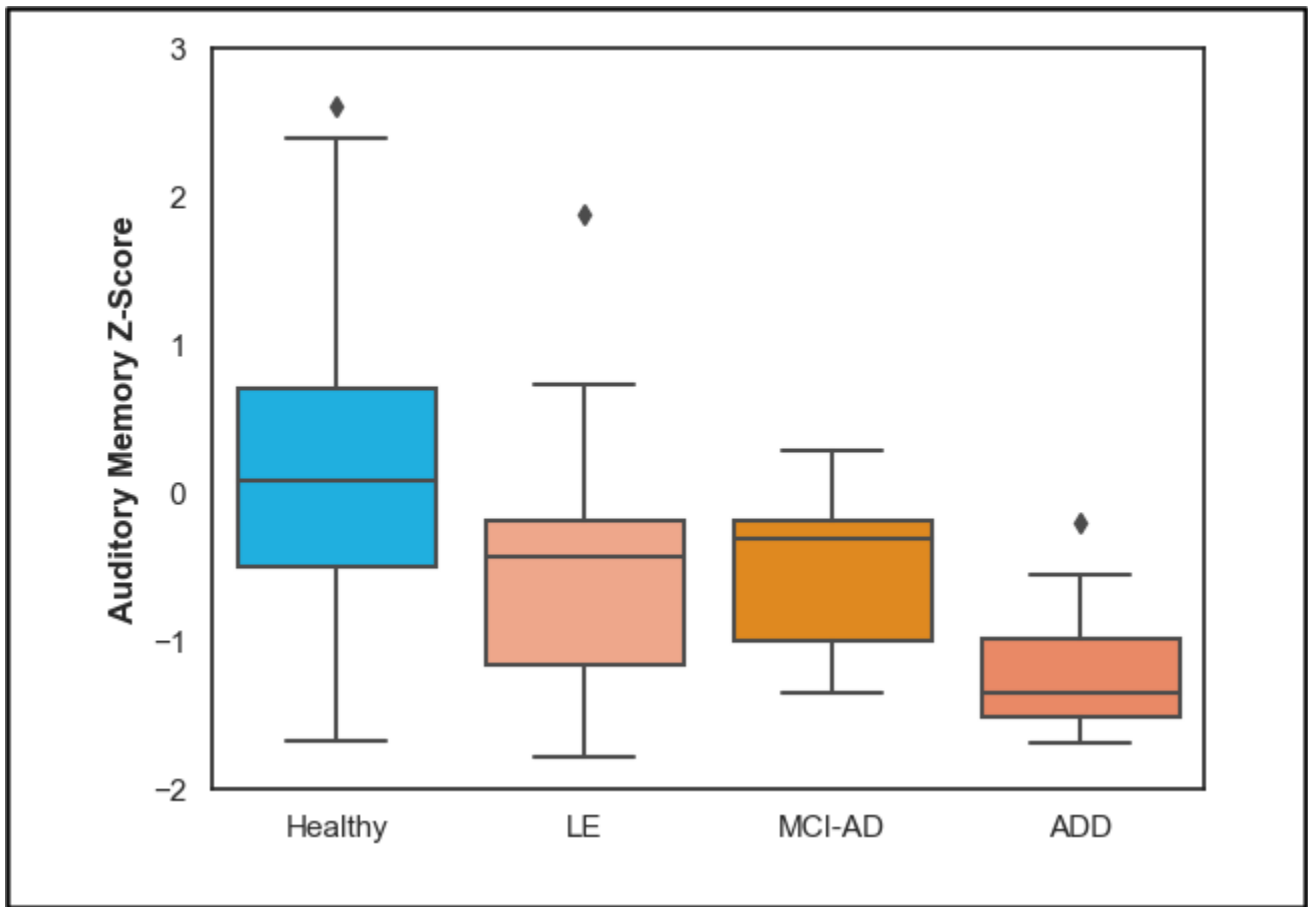

Figure 5.1. A boxplot showing Auditory Memory performance for AM rate (z-scores) between groups. There is a gradual reduction in performance from 'Healthy' participants (blue) to those with a diagnosis of 'Limbic Encephalitis (LE)' (light pink) and 'Mild Cognitive Impairment due to Alzheimer's Disease (MCI-AD)' (orange) to 'Alzheimer's Disease Dementia (ADD)' (dark pink).

Table 5.3 - Classification Accuracy of Various Linear Models

| | <u>CN</u> | <u>LE</u> | <u>MCI-AD</u> | <u>AD Dementia</u> |
|----------------------------------|------------------|------------------|----------------------|---------------------------|
| Age + PTA | 0.61 | 0.53 | 0.75 | 0.62 |
| Age + PTA + DiN | 0.67 | 0.58 | 0.86 | 0.61 |
| Age + PTA + SiB | 0.86 | 0.55 | 0.14 | 0.80 |
| Age + PTA + SiN | 0.90 | 0.54 | 0.29 | 0.75 |
| Age + PTA + SiB + AuM (A) | 0.94 | 0.59 | 0.67 | 0.82 |
| Age + PTA + SiN + AuM (A) | 0.94 | 0.62 | 0.76 | 0.82 |
| Age + PTA + SiN + AuM (F) | 0.94 | 0.58 | 0.33 | 0.75 |

The table shows the classification accuracy (0-1) for the various logistic regression models (first column) and the respective participant groups. A higher value indicates a better model performance.

AuM (A) - auditory memory for AM rate, AuM (F) - auditory memory for frequency, CN - cognitively normal, LE - limbic encephalitis, MCI-AD - mild cognitive impairment due to Alzheimer's disease, PTA - pure tone audiometry, DiN - Digits-in-Noise task, SiB - Speech-in-Babble task, SiN - Speech-in-Noise composite score.

5.4. Discussion

This study shows how auditory cognitive abilities are different in 'Cognitively Normal' individuals, those with AD and with people with medial temporal lobe lesions like LE. Central abilities for SiN perception and AuM are most informative about cognitive impairment in these conditions and have higher classification accuracy for a particular group when a combination of these are used alongside peripheral measures like PTA thresholds. Importantly, they may also provide additional useful information about a person's condition when compared to conventional neuropsychological tests used in the clinic like the ACE-3, as illustrated by the case description of the participant with FCD who had poor ACE-3 scores but auditory metrics that predicted a 'Cognitively Normal' state.

5.4.1. *Predictive Accuracy of Auditory Cognitive Metrics for AD dementia*

In the previous chapter, I showed that SiN perception ability is complex and can be dependent on various cognitive factors like AuM, depending on the duration of the stimuli used to assess it. AuM is a cognitive ability that is also potentially supported by medial temporal lobe structures, which makes it a good candidate to form a link between hearing ability and AD dementia. Neuropathology can directly disrupt auditory cognition supported by these regions. Therefore, I hypothesised that these hearing measures may provide valuable discriminative power between the 'Cognitively Normal' individuals and patients with a diagnosis of MCI-AD and AD dementia.

The results show that a combination of variables including age, PTA thresholds, SiN ability and performance on the AuM for AM rate had the highest classification accuracy for a participant being 'Cognitively Normal' with an AUC of 0.94 whereas that for AD dementia was 0.81. Compared to individual models with just age, PTA and SiN ability measured as DiN or SiB thresholds or the composite SiN measure used in the previous chapter, the addition of AuM for AM rate allowed better classification accuracy for 'Cognitively Normal' and AD dementia participants. The additional benefit of this task for categorising these clinical states is an important step to show that central hearing abilities may be potentially affected in a dose-dependent manner in the course of the disease. The classification accuracy of people with MCI-AD was likely to have been affected by the inclusion of LE participants in the model who

were of a similar cognitive profile. The implications for this are discussed further in the next section.

Examining the individual group-level metrics show that there are specific factors that are helpful for classifying different groups. Peripheral hearing metrics like the PTA threshold did not adequate discriminative power from chance for any of the groups from each other. However, all of the auditory cognitive metrics showed useful differences between participants with AD dementia and those without dementia. This was a similar finding to that observed in other cross-sectional work in the literature (Gates et al., 2008; Tuwaig et al., 2017). The battery of tests including the Huggins pitch perception task where people with AD dementia also performed poorly compared to other groups. The task does involve the recognition of a pitch without a noisy background, which may depend on an individual's ability to devote adequate attention to all of these components (Cramer and Huggins, 1958). Functional imaging data suggests that brain activity to this stimulus can relate to activity in the auditory cortex like other sounds that have pitch (Chait et al., 2006). Although the predominant deficit in the AD dementia patients' cognition was with regards to their memory, the participants may have had subtle attentional deficits that were not captured by the tests used in this study.

AuM for AM rate showed a stepwise decline from 'Cognitive Normal' participants to those with LE or MCI-AD, then to people with a diagnosis of AD dementia. This measure, along with AuM for frequency, also showed a moderate association with ACE-3 scores in studies, making it an appealing additional marker to potentially measure cognitive impairment in AD dementia. The mechanism for this association is likely to be via the activation of medial temporal lobe pathways involved in episodic memory, which degenerate in AD. Conventional neuropsychological stimuli for episodic memory involve language-based stimuli like paragraphs and words that are confounded by semantic and lexical processing abilities. AM white noise stimuli, on the other hand, represents basic sound below the level of speech, which people are ubiquitously exposed to in everyday speech, regardless of language, and this acoustic feature could be an important, relatively unbiased, stimulus choice to probe memory function in AD.

5.4.2. *Comparison between AD and LE patients*

People with LE and MCI-AD are potentially similar in the extent of medial temporal lobe damage they have despite the different underlying pathologies affecting these regions. In LE, there is inflammation of the medial temporal lobe due to autoimmunity that results in a static insult if treated appropriately whereas in AD the medial temporal lobe, and other brain regions, suffer from a progressive accumulation of neuropathology. In AD, the earliest stages of NFT deposition occur in the medial temporal lobe, which correlates with the episodic memory deficits in MCI-AD (Braak and Braak, 1991). However, these difficulties may not be severe enough to have an impact on an individual's activities of daily living (Jack et al., 2018). People with LE, especially those with LGI-1 encephalitis, can recover to baseline function but with subtle enduring deficits in episodic memory function, often with normal ability to function independently as well (Butler et al., 2014; Miller et al., 2017). Some studies have suggested this is due to focal hippocampal damage (Miller et al., 2020). Therefore, both of these conditions could potentially be used to study the impact of subtle medial temporal lobe lesions on cognitive function.

The AudCog cohort of LE and MCI-AD patients were very similar in terms of their cognitive scores and I expected similar levels of performance on the auditory cognitive measures related to memory processes if the underlying neural substrates for these functions were the same. This also explains why the logistic regression model was not able to separate these groups with a high degree of accuracy. The SiN and AuM for AM rate measures showed values between those of the 'Cognitively Normal' and AD dementia participants. This gives credence to the hypothesis that mild medial temporal lobe damage can be detected by specific tests of auditory cognition. Evidence from the visual working memory literature also suggests that such tests can be used to monitor response to therapy (Pertzov et al., 2013). People with LE show an improvement in their visual memory precision after completing a course of immunosuppressive therapy. With the advent of therapy for AD, such tests, including the AuM for AM rate measure, may prove to be useful to monitor cognitive function after treatment.

5.4.3. *Musical Sophistication, Auditory Memory for Frequency and Dementia*

There has been considerable interest in the scientific literature about the relationship between musical ability and risk of dementia. For example, there is evidence for protective effects for

musical instrumentation against dementia and for late-life cognition (Walsh et al., 2021a, 2021b). However, sparse data at various life phases of the participants in these cohort studies make it difficult to make causal claims. This study was not specifically designed to assess causal claims about musical sophistication and dementia risk but to assess how auditory cognitive skills may be impacted by it at a cross-sectional level. My previous work has shown that AuM precision for frequency is associated with a moderate strength with musical sophistication scores on the GMSI and I replicated this finding (Lad et al., 2021). Therefore, although a discussion about musical sophistication and its protective effects against dementia is beyond the scope of this thesis, it is an important variable that is needed to consider to moderate AuM precision scores for frequency.

The previous chapter showed that AuM precision for AM rate, with other auditory and demographic variables, explained a larger degree of variance when predicting SiB ability as compared to that for frequency. Due to the relationship between AuM precision for frequency and musical sophistication scores, the latter was added as a regressor in the linear models that included AuM for frequency in the previous chapter. The different groups in this study were not balanced for GMSI scores, with the 'Cognitively Normal' group scoring higher than other groups. As the logistic models could use this imbalance to falsely classify groups accurately, this was not used as a covariate of interest. The models with AuM for frequency did not perform better than those that had AuM precision for AM rate at classifying the various participant groups. An explanation for this finding may be that AuM for frequency, a feature that is important when identifying the source of speech from a particular speaker, may not be important for general SiN perception ability (Darwin and Hukin, 2000). This study needs to be replicated in populations with groups balanced for musical sophistication so that any effects of AuM for frequency can be adequately studied.

5.4.4. Auditory Cognition of Non-neurodegenerative Mild Cognitive Impairment

Auditory cognition may capture information not addressed by conventional neuropsychological tests, thereby increasing its utility for understanding non-neurodegenerative cognitive disorders like MCI due to other causes. This was illustrated by the case of the patient with FCD who was classified by the logistic regression model as being 'Cognitively Normal'. This particular patient from the AudCog study was initially suspected to have MCI-AD but was later diagnosed as

having FCD after a detailed collateral history and encounters with other healthcare professionals other than his usual care team. Although this study indicated a positive linear relationship between AuM precision and cognitive scores, the former is tested indirectly through a computer rather than with another person questioning a participant. This may have been one reason why the participant performed better in the AuM tests.

In the AudCog study, the auditory tasks were conducted as part of research and not in the focus of attention as during the patient's clinical assessment. The patient did still perform poorly on the ACE-III examination that was conducted as part of the study, highlighting the 'internal inconsistency' that is evident in people who have a diagnosis of FCD (Ball et al., 2020). For this particular patient, the 'normal' performance on the auditory tasks indicated that the individual cognitive components required to execute such tasks were intact but there was difficulty engaging them when they became the focus of attention as with the ACE-III examination. Metacognitive deficits, where there are specific impairments in an individual's monitoring of their cognitive function rather than the latter itself, have been proposed as a potential mechanism to explain FCD (Bhome et al., 2019). Further work is needed with a much larger group of such patients to see if this finding holds and can be replicated. Incorporating confidence ratings of AuM performance after every trial can help study whether an expected relationship between metacognition and objective performance exists for AuM as described in the literature (Fleming and Lau, 2014).

5.4.5. *Limitations*

There are several limitations of this study which need to be considered when interpreting the findings. Firstly, the size of the patient groups was small and could represent a sampling bias as there was a much larger sample of 'Cognitively Normal' participants as compared to patients. Although the findings support trends which are well described in the literature, such as a progressive impairment of cognition from 'Cognitively Normal' to MCI-AD to AD dementia, the accuracy of the predictive metrics would be influenced by the imbalanced groups. Furthermore, this meant that I was unable to train the models on separate data to which they were tested. Therefore, it is possible that the model with SiN and AuM precision for AM rate is not the best at predicting the different groups of participants as it may suffer from overfitting its parameters to the training data. Another major statistical assumption in the analysis is that the relationships

between the chosen variables are linear. At an individual level, people have thresholds or points at which they may be severely detrimental to cognitive function. At these points, non-linear relationships may exist and are not accurately captured by the models used in this study. A larger sample size will allow a comparison of a variety of models to test this.

There are also potential limitations to do with the makeup of the AD patient groups. With regards to AD patients, not all of them had CSF biomarkers, either due to the diagnosis being made in Old Age Psychiatry services which do not have access to these tests or the nature of the case such that it was not required or possible in the Neurology Cognitive Clinic. This makes it difficult to be extremely confident about the underlying neuropathological basis for disease. This is particularly the case with MCI-AD participants in whom it may be difficult to predict the long-term course of their condition from a cross-sectional appointment. However, all of these participants either stayed the same cognitively after a year or worsened to a diagnosis of AD dementia (3 participants) subsequently. The patients that did not progress are being followed up to assess whether they deteriorate cognitively.

Another limitation pertains to the specificity of lesions in LE and AD to the medial temporal lobe. Although all patients were recruited to the AudCog study based on predominant memory impairments in their history and cognitive testing, neuroimaging may not have revealed atrophy in these regions. Despite published literature stating specificity of medial temporal lobe damage in LE, group-level comparisons have shown a variety of imaging changes (Rodriguez et al., 2022; Shao et al., 2020). Despite claims about hippocampal specificity of lesions, swelling of surrounding structures in the medial temporal lobe is evident in the acute phase of the encephalitic illness. This has also been found in AD where one of the earliest sites of NFT deposition is the entorhinal cortex, rather than the hippocampus (Herholz, 2022; Levin et al., 2021). The medial temporal lobe, specific subregions are said to be functionally specialised and therefore not knowing the extent of the medial temporal lobe damage in each individual with AD or LE in the AudCog study could be a shortcoming (Argyropoulos et al., 2022; Barense et al., 2005).

6. Neuroanatomy of Auditory Cognition in Health and Alzheimer's Disease Dementia

6.1. Introduction

Neuroimaging is an integral part of the clinical diagnostic pathway for AD dementia and the presence of medial temporal lobe changes such as hippocampal atrophy is used as key supporting evidence for diagnosis (Jack et al., 2011). Such atrophy markers are widely used in observational AD studies and clinical trials as a biomarker of the neurodegenerative disease process. Therefore, novel markers of AD need to consider hippocampal volume, and other relevant regions, as important variables when considering direct or indirect effects of AD neuropathology. This chapter presents the evidence from using structural MR analytical methods such as volumetry and morphometry, and dMRI to assess whether auditory cognitive metrics from the previous chapter are associated with these brain-derived measures.

6.1.1. *Grey Matter Measures Predicting Alzheimer's Disease*

Brain atrophy occurs due to neuronal atrophy on a cellular scale, which occurs due to neurodegeneration in AD. Therefore, there is great interest in measuring this accurately at a whole-brain or regional level to predict dementia onset. Evidence for using medial temporal lobe brain atrophy as a marker for impending AD dementia comes from a variety of cross-sectional and longitudinal studies. Hippocampal atrophy rates over a decade have also been shown to be an early marker of memory decline and dementia (den Heijer et al., 2010). Hippocampal volume is also predictive of AD dementia conversion from MCI-AD (Jack et al., 1999). Recently the availability of *in-vivo* biomarkers of A β and NFTs with PET tracers have also allowed researchers to characterise atrophy in relation with these and there exists a close relationship between the spatiotemporal distribution of these markers and subsequent hippocampal atrophy (Aschenbrenner et al., 2018). Some studies have also found that other medial temporal lobe regions like the entorhinal cortex volume are better predictors of AD dementia from a non-demented state (Dickerson et al., 2001).

AD dementia can also be present without medial temporal lobe atrophy and accurate measurements of brain regions in other areas have allowed better characterisation of the disease process. Cortical volumetry and thickness measurements are now made possible by advanced neuroimaging techniques such as morphometry and these have provided further insight into structural brain changes that occur in AD dementia (Dickerson et al., 2009). A signature of cortical thinning, outside the medial temporal lobe, is present in nine bilateral cortical regions including the angular gyrus, precuneus, supramarginal, superior frontal, superior parietal, temporal pole, inferior temporal, medial temporal and inferior frontal cortex (Bakkour et al., 2009). Measuring cortical thickness in these regions has been shown to predict progression along the AD spectrum and changes here are also affected by disease severity. Therefore, these are also important regional markers to consider in AD.

6.1.2. Diffusion weighted MR markers of Alzheimer's Disease

dMRI has shown that there are extensive white matter changes in the brains of people diagnosed with AD dementia as compared to age-matched healthy volunteers (Bozzali et al., 2002). Metrics such as the mean diffusivity (MD) and fractional anisotropy (FA) show differences in the corpus callosum and white matter in the frontal, temporal and parietal lobes between these groups. Another study found abnormalities in FA in the posterior corpus callosum and the anterior and posterior cingulate bundles in patients with AD dementia (Takahashi et al., 2002). Other work has also found that microstructural white matter changes in these regions, measured using FA, is also abnormal in people at an increased risk of AD dementia such as those with APOE4, a parental family history of AD dementia and advanced age (Adluru et al., 2014). The exact reasons and mechanisms underlying these white matter changes are unclear but this modality provides additional information about the neurodegenerative or related processes occurring in AD.

Recent advances in multi-shell diffusion MRI modelling have allowed researchers to show that white matter abnormalities in the brain, that are more widespread than the regions mentioned in the previous paragraph, are present in people with AD dementia (Giraldo et al., 2022). Macroscopic and microscopic changes are present in the white matter bundles of the splenium, the cingulum, corticospinal tract and the inferior longitudinal fasciculus. Although these changes appear widespread and non-specific, they have also been shown in other work to be related to

cerebrospinal fluid neurodegenerative biomarkers related to AD (Alm and Bakker, 2019). However, the latter study used simpler modelling techniques with DTI and older biomarkers such as A β 42 and total-Tau. Newer and better currently available markers have not been studied alongside diffusion MRI metrics.

6.1.3. *Brain markers of Auditory Cognition in Health and Disease*

Peripheral hearing loss does not seem to be associated with whole-brain structural grey matter volumetric changes over time (Slade et al., 2022). However, specific atrophy has been found in the temporal lobe and auditory cortex in people with hearing loss who have been followed up over time (Eckert et al., 2019; Lin et al., 2014). There have been no studies that have looked at whether these changes occur due to an interaction of neuropathology seen in AD in the brain or not and further work is needed to clarify this. Atrophy has also been found in the medial temporal lobe as a result of poor SiN perception ability (Wang et al., 2022b). Poor subjective hearing in this study was also associated with an increased CSF Tau measurement potentially supporting a direct link between hearing loss and AD neuropathology. However, as mentioned in the earlier part of this thesis, subjective hearing loss may not be the best measure of hearing loss to assess dementia risk. It is important to standardise hearing loss measurements across studies and be clear about the type of hearing loss present as this may refer to distinct abilities that are dependent on different neural substrates.

Volumetric changes have been identified in relation to different central auditory abilities in AD. Grey matter volume in the posterior cortical areas including the posterior cingulate gyrus correlates with metrics for auditory scene analysis metrics in people diagnosed with AD dementia (Goll et al., 2012). The tasks that the patients performed, in this study, tested an individual's ability to group and segregate elements of an auditory scene over a number of seconds. The work also showed that this ability was influenced by non-verbal working memory capacity. Impaired speech comprehension in AD dementia has also been associated with atrophy of the left planum temporale, angular gyrus and anterior cingulate gyrus; structures which are involved in processing speech in difficult to hear environments (Jiang et al., 2023). Studies looking at other measures such as cortical thickness and white matter integrity are lacking in this area.

6.1.4. *Aims and Objectives*

The aim of this study was to evaluate the relationship of brain morphometry and diffusion metrics with the auditory cognitive metrics studied in the previous chapter. The specific objectives included:

1. Assess the relationship of the cortical regions in the AD signature regions, including the medial temporal lobe, and auditory processing regions with SiN thresholds and AuM precision measures.
2. Assess white matter diffusion metrics reflecting the AD disease process in relation to the auditory cognitive scores in the AudCog study.

6.2. **Methods**

6.2.1. *Participants*

48 participants from the AudCog study participated in the imaging study. These included 24 healthy participants, 6 people with LE, 7 people with MCI-AD and 11 with AD dementia. Further details of these participants are provided in Table 6.1. Each participant underwent a T1-weighted structural MRI scan, T2-weighted hippocampal scan and a dMRI scan. These are described in more detail below.

6.2.2. *MR Acquisition*

All MRI scans were acquired on a Philips Achieva 3T scanner in one session, lasting around 36 minutes on average, at the MR Centre at the Centre for Ageing and Vitality at Newcastle University, Newcastle upon Tyne, UK.

T1-weighted images were acquired with a magnetisation prepared rapid gradient echo (MPRAGE) sequence, sagittal acquisition, echo time 4.6 ms, repetition time 8.3 ms, inversion time 1250 ms, flip angle=8°, SENSE factor=2, in-plane field of view 240 × 240 mm² with a slice

thickness of 0.8 mm, yielding a voxel size of $0.8 \times 0.8 \times 0.8 \text{ mm}^3$. T2-weighted hippocampal images were taken with a repetition time of 11,000 ms, inversion time 2800 ms, echo time 125 ms voxel size $0.94 \times 0.94 \text{ mm}$, 50 slices with thickness of 3 mm.

dMRI scanning was performed with sequences mirroring that of the UK Biobank study. Spin echo Echo Planar Imaging was performed with an echo time of 45.5 ms, a repetition time of 6126 ms, field of view $104 \times 104 \times 72$. A multishell diffusion scheme was used, and the b-values were 1000 and 2000 s/mm^2 . The number of diffusion sampling directions were 50 and 50, respectively. The in-plane resolution was 2.10938 mm. The slice thickness was 2.11 mm. 5 images with b-value of 0 s/mm^2 and a blip-reversed b0 scan for distortion correction were acquired.

Table 6.1 - Participant characteristics for MR study

| | CN | LE | MCI-AD | AD Dementia |
|----------------------------------|--------------|------------|---------------|--------------------|
| Count (n) | 24 | 6 | 7 | 11 |
| Age (years) | 70.9 (5.1) | 70.1 (7.2) | 73.2 (8.1) | 74.5 (4.3) |
| Gender (%) | | | | |
| <i>Male</i> | 54% | 67% | 29% | 55% |
| <i>Female</i> | 46% | 33% | 71% | 45% |
| Education (most frequent) | 2 | 1 | 2 | 1 |
| Cognitive Scores | | | | |
| <i>ACE-III (/100)</i> | 95.9 (2.8) | 89.8 (4.8) | 87.4 (5.4) | 71.2 (10.9) |
| <i>Memory (/26)</i> | 23.5 (2.2) | 20.0 (1.7) | 17.7 (4.1) | 10.2 (5.9) |
| <i>Language (/26)</i> | 25.9 (0.2) | 25.7 (0.8) | 25.7 (0.8) | 25 (2.0) |
| <i>GMSI (/)</i> | 150.5 (33.2) | 124 (15.8) | 128.1 (31.2) | 116.2 (21.6) |

Baseline characteristics for all participants in the MR study.

ACE-3- Addenbrooke's Cognitive Examination (Third Edition), GMSI- Goldsmiths Musical Sophistication Index, CN- Cognitively Normal, LE- Limbic Encephalitis, MCI-AD- Mild Cognitive Impairment due to Alzheimer's Disease. Variability for numerical group level statistics is indicated as a standard deviation in parentheses. Education status is graded into 1 - left school at the age of 15, 2 - completed school or has one additional qualification, 3 - multiple professional qualifications.

6.2.3. Preprocessing

Volumetric and cortical thickness anatomical scan results included in this manuscript come from preprocessing performed using fMRIPrep 23.1.3 (Esteban et al., 2019), which is based on *Nipype* 1.8.6 (Gorgolewski et al., 2011). The T1-weighted images were corrected for intensity non-uniformity (INU) with *N4BiasFieldCorrection*, distributed with ANTs, and used as T1-weighted reference throughout the workflow (Avants et al., 2008; Tustison et al., 2010). The T1-weighted reference was then skull-stripped with a *Nipype* implementation of the *antsBrainExtraction.sh* workflow (from ANTs), using OASIS30ANTs as target template. Brain tissue segmentation of cerebrospinal fluid (CSF), white-matter (WM) and grey-matter (GM) was performed on the brain-extracted T1-weighted using *fast* (FSL) (Zhang et al., 2001). Brain surfaces were reconstructed using *recon-all* (FreeSurfer 7.3.2), and the brain mask estimated previously was refined with a custom variation of the method to reconcile ANTs-derived and FreeSurfer-derived segmentations of the cortical grey-matter of Mindboggle (Dale et al., 1999; Klein et al., 2017). Volume-based spatial normalisation to one standard space (MNI152NLin2009cAsym) was performed through nonlinear registration with *antsRegistration* (ANTs), using brain-extracted versions of both T1-weighted reference and the T1-weighted template. The following template was selected for spatial normalisation and accessed with *TemplateFlow* (23.0.0): *ICBM 152 Nonlinear Asymmetrical template version 2009c* [TemplateFlow ID: MNI152NLin2009cAsym] (Circic et al., 2022; Fonov et al., 2009).

The susceptibility artefact was estimated using reversed phase-encoding b_0 by TOPUP from the Tiny FSL package (<http://github.com/frankyeh/TinyFSL>), a re-compiled version of FSL TOPUP (FMRIB, Oxford) with multi-thread support. FSL *eddy* was used to correct for eddy current distortion. The correction was conducted through the integrated interface in DSI Studio ("Chen" release)(<http://dsi-studio.labsolver.org>). The accuracy of b-table orientation was examined by comparing fibre orientations with those of a population-averaged template (Yeh et al., 2018). The diffusion data were reconstructed in the MNI space using q-space diffeomorphic reconstruction to obtain the spin distribution function (Yeh et al., 2010; Yeh and Tseng, 2011). A diffusion sampling length ratio of 1.25 was used. The output resolution in diffeomorphic reconstruction was 2.11 mm isotropic. The restricted diffusion was quantified using restricted diffusion imaging (Yeh et al., 2017). The tensor metrics were calculated using DWI with b-value

lower than 1750 s/mm². Quantitative Anisotropy (QA) was extracted as the local connectome fingerprint and used in the connectometry analysis (Yeh et al., 2016b).

6.2.4. *Data Analysis*

Three ROIs were created for grey matter volume and thickness analysis. The first included regions that form part of the AD signature regions bilateral regions including the angular, precuneus, supramarginal, superior frontal, superior parietal, temporal pole, inferior temporal, medial temporal and inferior frontal cortex. Medial temporal lobe regions included the hippocampus, entorhinal and parahippocampal areas. For volumetric analysis, grey matter volumes of the entorhinal cortex, parahippocampus and hippocampus were added together. For cortical thickness, the mean value of only the first two regions were used. The third ROI included the auditory cortex which included Heschl's gyrus, planum temporale and the lateral aspect of the superior temporal gyrus. They were defined from the Freesurfer parcellations using the Destrieux atlas. These values were adjusted for the effect of age, sex and total intracranial volume using a multiple regression model.

48 MRI scans were included in the connectometry database for diffusion MRI analysis. Diffusion MRI connectometry was used to derive the correlational tractography that has a longitudinal change of QA correlated with variables of interest to be predicted (Yeh et al., 2016a). QA measures the anisotropy of a diffusion process in biological tissue and is less affected by oedema. It is also better related to axonal density than FA, which is non-specifically related to axonal integrity. A nonparametric Spearman partial correlation was used to derive the correlation, and the effect of age and sex was removed using a multiple regression model. A T-score threshold of 2.5 was assigned and tracked using a deterministic fibre tracking algorithm to obtain correlational tractography. A seeding region was placed at the whole brain (38,47,28) (Yeh et al., 2013). The tracks were filtered by topology-informed pruning with 16 iteration(s) (Yeh, 2020). A False Discovery Rate (FDR) threshold of 0.05 was used to select tracks. To estimate the FDR, a total of 4000 randomised permutations were applied to the group label to obtain the null distribution of the track length.

6.3. Results

6.3.1. *Morphometric Measures by Diagnosis*

Significant differences were observed in the adjusted volumes and thickness of various brain regions across the diagnostic groups (control, MCI-AD, and AD dementia) where there was a gradual reduction in morphometric values from control participants to MCI-AD and then to AD dementia (Figure 6.1).

Significant differences among the diagnostic groups were revealed by the ANOVA tests. For the total volume of AD signature regions, a highly significant difference was observed ($F = 13.97$, $p < 0.0001$). Similarly, the mean cortical thickness of AD signature regions showed a significant difference ($F = 8.79$, $p < 0.001$). In the medial temporal lobe regions, both the total volume ($F = 10.98$, $p < 0.001$) and mean cortical thickness ($F = 8.66$, $p < 0.001$) exhibited significant differences. Furthermore, in the auditory regions, significant differences were observed for both the total grey matter volume ($F = 13.97$, $p < 0.0001$) and the mean cortical thickness ($F = 8.79$, $p < 0.001$).

6.3.2. *Relationship of Morphometric Measures with Auditory Cognitive Metrics*

An assessment into the relationship between various brain metrics and auditory functions in individuals with different diagnoses, including control, MCI-AD, and AD dementia, was conducted.

The analysis revealed significant correlations between adjusted volumes of various brain ROIs and auditory metrics, specifically z-scores for SiN perception scores and AuM for amplitude modulated sounds. Specifically, the adjusted volume of AD signature regions was found to have a weak positive correlation with both SiN ($r = 0.302$, $p = 0.037$, $BF = 1.5$) and AuM ($r = 0.354$, $p = 0.014$, $BF = 3.5$). Similarly, the adjusted volumes of MTL regions showed a weak positive relationship with SiN ($r = 0.171$, $p = 0.245$, $BF = 0.3$) that was not statistically significant and one with AuM ($r = 0.333$, $p = 0.021$, $BF = 2.4$) which was. Auditory regions showed significant

positive relationships with SiN ($r = 0.302$, $p = 0.037$, $BF = 1.5$) and AuM ($r = 0.354$, $p = 0.014$, $BF = 3.5$) as well.

Analysis of cortical thickness and auditory metrics also showed correlations with AD signature regions and SiN ($r = 0.250$, $p = 0.087$, $BF = 0.8$) that was not statistically significant, and AuM ($r = 0.285$, $p = 0.049$, $BF = 1.2$) which was. Medial temporal lobe thickness was significantly associated with SiN ($r = 0.300$, $p = 0.040$, $BF = 1.4$) and AuM ($r = 0.400$, $p = 0.005$, $BF = 8.5$). Auditory region thickness was not significantly associated with SiN ($r = 0.250$, $p = 0.087$, $BF = 0.7$) but was with AuM ($r = 0.285$, $p = 0.049$, $BF = 1.2$) performance.

6.3.3. Diffusion MRI Metrics

Groupwise differences across the participants (healthy control to MCI-AD to AD Dementia) was assessed using diffusion MRI connectometry as described above. Tracts that had a decreased QA across from 'Cognitively Normal' to MCI-AD to AD Dementia were identified with tractography. The tracts surviving the FDR threshold were then manually identified using the tract atlas in DSI Studio.

The tracts which had a decreased QA with increasing suspected AD included the anterior and superior thalamic radiation, the corpus callosum body and tapetum, the fornix and the cingulum bundles. The QA from all of these tracts was extracted to determine individual-level data, to understand group-level differences. Statistical evaluation using a one-way ANOVA confirmed that there were significant differences in QA values among groups ($F(2, 48) = 7.97$, $p = 0.00125$). To discern which specific groups exhibited significant differences in QA, a post-hoc Tukey's HSD test was conducted. The difference in QA between the Control group and the AD Dementia group was statistically significant, with the latter group showing a decrease in QA. However, the differences in Adjusted QA between the Control and MCI-AD groups, and between the MCI-AD and AD Dementia groups, did not reach statistical significance.

A significant positive relationship was observed between the QA of these tracts and SiN performance in the AudCog study ($r = 0.420$, $p < 0.005$) suggesting a moderate strength of association between the two variables. A trend was observed in the association with AuM for AM scores ($r = 0.216$, $p > 0.05$).

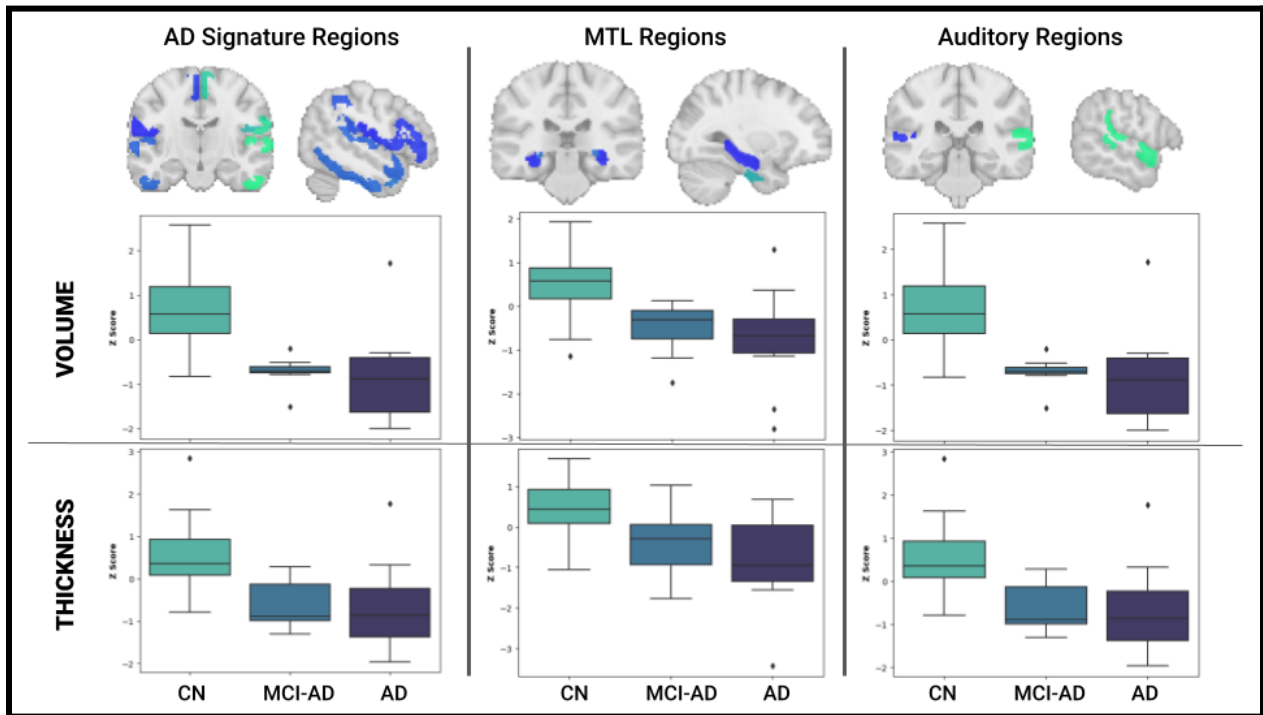

Figure 6.1. *Group-wise ROI-based morphometry.* The figure shows morphometry results in the AD signature regions (left pane), medial temporal lobe (MTL) regions (middle pane) and auditory regions (right pane). Z-scores for total grey matter volume in each region are plotted in the top row for cognitively normal individuals (light green colour), people with MCI-AD (teal colour) and AD dementia (dark blue colour). Z-scores for mean cortical thickness in each region are plotted in the bottom row for cognitively normal individuals (orange colour), people with MCI-AD (red colour) and AD dementia (dark purple colour). All morphometric measures show a decrease from cognitively normal to MCI-AD to AD participants.

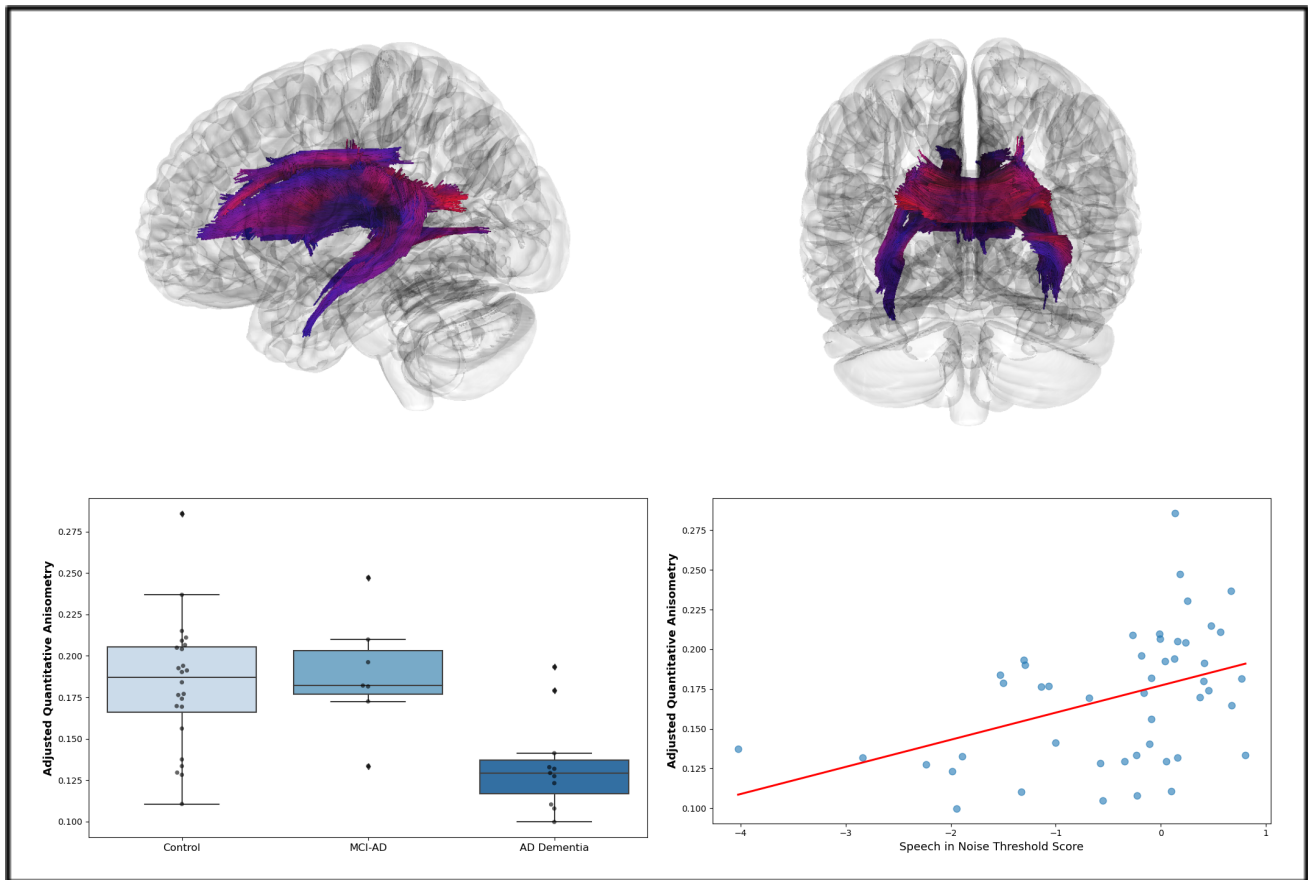

Figure 6.2. *Diffusion MRI Correlation Tractography.* The figure shows tractography results in participants across participants from cognitively normal to MCI-AD to AD dementia. The top row shows a 3D reconstruction of the tracts that show a negative relationship in quantitative anisotropy (QA) with disease severity (red indicates lower QA scores). The boxplot in the bottom left pane shows mean QA measures across all the tracts plotted separately for each group ('control' in light blue, 'MCI-AD' in blue and 'AD Dementia' in dark blue). The pane in the bottom-right shows mean QA shows plotted alongside z-scores for speech-in-noise perception ability results, showing a positive relationship with moderate strength ($r = 0.42$, $p < 0.005$).

6.4. Discussion

The study described in this chapter shows how structural neuroimaging measures that are affected across the AD continuum are related to central auditory measures such as SiN perception ability and AuM for sound features over seconds. The study presents cross-sectional evidence linking auditory behavioural performance to neuroimaging markers related to neurodegeneration in AD, suggesting a direct link between central hearing and neurodegeneration.

6.4.1. *Cortical volume and thickness are associated with central auditory function*

The ageing brain manifests as changes in the grey matter such as atrophy and cortical thinning. Whether these changes reflect a neurodegenerative disease process can be difficult to ascertain but studies have shown that AD produces changes in non-overlapping regions that are distinct from ageing and are predictive of dementia (Bakkour et al., 2013, 2009). However, there is great heterogeneity in the neuroimaging appearances of AD with various atrophy patterns being described (Dickerson et al., 2017; Möller et al., 2013; Poulakis et al., 2018). Medial temporal lobe atrophy is conventionally associated with AD dementia but in some cases volume in this region is unaffected and cortical atrophy in other areas is more prominent. The central auditory measures described in this thesis have never been studied alongside brain imaging measures before. Therefore the initial aim of this chapter was to study brain-behaviour associates using ROIs in AD signature regions, medial temporal lobe regions and auditory brain regions.

All brain morphometric measures showed consistent associations with both auditory metrics suggesting that the latter may be directly linked to the neurodegenerative process. The AD signature region volumes and mean thickness measures were significantly associated with both SiN perception ability and AuM, potentially suggesting overlapping neural substrates involving these regions. AuM for AM sounds also showed moderate associations with medial temporal lobe metrics, mean thickness being the strongest association. This was expected due to the emerging literature showing the importance of medial temporal lobe regions in memory for visual and auditory objects over several seconds (Borders et al., 2022; Zokaei et al., 2019;

Zokaei and Husain, 2019). Grey matter volume in the auditory regions showed stronger associations with the auditory metrics than mean thickness and it is unclear how they may be linked mechanistically as AD pathology is seldom present in these regions (Esiri et al., 1986). Whether this relationship captures a non-AD related process linked to cognitive impairment in dementia in general or something else needs further study by including groups with non-AD dementias in the cohort.

In-vivo neuroimaging with PET tracers has shown that Tau accumulation is inversely related to cortical thickness (Xia et al., 2017). Tau pathologic changes in post-mortem studies have been associated with neuronal loss, gliosis and other evidence of neurodegeneration in AD in cross-sectional studies (Gómez-Isla et al., 1997). MRI atrophy has also been linked to NFT pathology post-mortem (Whitwell et al., 2012, 2008). These findings would support the potential interaction of Tau pathology and central auditory function as a link between hearing loss and dementia (Griffiths et al., 2020). However, a complex relationship between Tau accumulation and brain atrophy is observed when AD is studied using longitudinal methods, where this may not be a linear process over time and so the relationship between these variables appears to be complex (Sintini et al., 2020).

6.4.2. *White matter abnormalities in AD are related to SiN performance*

White matter alterations, potentially related to cerebrovascular disease or neurodegenerative disease itself, have been shown to exacerbate cognitive symptoms across the AD continuum (Marchant et al., 2012). They have also been associated with neuroinflammation in the central nervous system, independent of AD neuropathology (Gertje et al., 2023). These changes include both changes in the macrostructure, such as white matter tracts and bundles, and microstructural properties that provide more fine grained information about white matter integrity. Tracts involving the cingulum and corpus callosum are consistently identified as being affected in AD in the literature and in this work (Giraldo et al., 2022). The neuroimaging study presented in this chapter showed similar findings where the cingulum and tracts from the corpus callosum were identified as being related to disease severity from a healthy state to MCI-AD to AD dementia.

Further analysis also showed that the white matter tract metrics that were isolated based on correlational tractography in these regions were significantly associated with SiN performance but not AuM scores. SiN ability is known to be a complex construct which is made up of multiple cognitive demands such as attention, executive function and working memory and this association may reflect the broad range of neural substrates supporting its function. It is also possible that this relationship may reflect disease processes specifically affecting the white matter in AD. AuM performance for AM rate, however, did not show any association with QA in the identified white matter tracts, perhaps suggesting a predilection towards cortical structures, which were identified in the previous section, supporting its function.

6.4.3. *Limitations and Future Directions*

There are certain limitations of the analysis methods used which should be taken into account when reflecting on the main findings of this study. General criticisms are applicable to the low sample size and the lack of genetic or biomarker data that could affect brain measures. For example, recent work has suggested that a much larger number of participants is needed to find meaningful and replicable relationships with brain and behavioural metrics (Marek et al., 2022). A mitigation against this observation is that this study included groups of participants with diseases affecting their brains and so the effect sizes for the differences are larger and thus the findings are likely to be replicable. The AudCog study also did not include measures such as APOE4 status and fluid biomarker data which could have been used to partial out potentially negative effects of brain grey matter and to stratify the participant groups accurately (Belloy et al., 2019; Jack et al., 2018). Although biomarker evidence was not present for the AudCog patient group, the differing group-level hippocampal volumes support a greater likelihood underlying AD pathology over other neuropathologies (Kantarci et al., 2016).

More recent work has utilised dMRI to examine grey matter with dMRI which can be performed with the AudCog dataset (Weston et al., 2015). Hippocampal MD measures at the MCI-AD stage have been shown to predict future conversion to AD dementia (Kantarci et al., 2005; Müller et al., 2005). When comparing hippocampal MD to dMRI measures of white matter tracts, the former has been shown to be better at predicting AD disease progression (Douaud et al., 2013). Other brain grey matter regions have shown elevated MD in established AD dementia including the posterior cingulate cortex, entorhinal cortex, amygdala and parahippocampal gyrus

(Dickerson et al., 2009). Areas in the default mode network seem to be important measures to use in any analysis with dMRI. Recent advances in dMRI analysis methods has shown that a new technique called free-water imaging could be used as a biomarker for disease progression in AD (Nakaya et al., 2022). Further research will include a study of these measures in a growing AudCog cohort.

7. Functional Neuroanatomy of Auditory Memory Precision

7.1. Introduction

Auditory memory (AuM) precision refers to the quality of memory for sounds over seconds. A higher precision will result in a better or more accurate memory for the sound and vice-versa. There is converging evidence from behavioural and neuropsychological studies that auditory memory over short time spans involves regions of the brain such as the hippocampus that have traditionally been associated with long-term memory processes (Yonelinas, 2013). Activity in these regions has been implicated in precise or 'high-resolution' memories. Evidence from the visual literature has shown that precision for visual memories is associated with increased activity in the hippocampus but studies with auditory stimuli are lacking (Borders et al., 2022). This chapter examines whether the hippocampus (HC), auditory cortex (AC) and inferior frontal gyrus (IFG), regions previously identified to be activated in memory for sounds over several seconds, contribute to the AuM precision during fMRI (Kumar et al., 2016).

7.1.1. *Auditory memory involving the Hippocampus*

Previous work has shown that memory for pure tones over seconds activates brain regions such as the AC, HC and IFG with fMRI (Kumar et al., 2016). The task used in this study required participants to listen to two pure tones and maintain a retro-cued tone in mind for 16 seconds. HC activity was present during the encoding, maintenance and retrieval phases. Using the same paradigm but a shorter maintenance interval of three seconds, intracranial recordings of local field potentials in the HC of patients undergoing invasive monitoring in preparation for epilepsy surgery showed low-frequency activity during this period (Kumar et al., 2021). This provided complementary evidence for the role of the hippocampus in memory for sounds over seconds with different neuroimaging modalities. Both these studies did not subsequently study HC activity in relation to behavioural responses during the task.

There have been recent attempts to link activity of medial temporal lobe regions to memory performance with fMRI with visual tasks (Borders et al., 2022). In this study, the authors used a task measuring visual memory for colour precision, an established paradigm that has provided

evidence for continuous resource allocation models of working memory (Ma et al., 2014). Similar to the AuM task, trial-by-trial precision or accuracy was measured using the error from a target parameter for a cued coloured square that is temporarily displayed to a participant. The visual experiment allowed one to test memory for multiple stimuli at the same time. Here, four coloured squares were displayed on a screen for 1 second during the encoding phase and a location probe indicated which colour the participant had to match on a given trial. The study showed that there was fMRI activity in the head and body of the HC during the maintenance phase of a trial that was related to the precision of the participant response in high vs. low accuracy trials. This would potentially suggest a role for HC activity during the maintenance phase in precise behavioural responses.

7.1.2. Auditory memory and other brain regions.

Activity in the AC during the maintenance period has been previously described as well (Linke et al., 2011; Linke and Cusack, 2015). However, there have been conflicting observations with one study showing a reduction in activity from baseline and the other activation. This is potentially due to differing attentional demands in the tasks used for these studies. Other fMRI work has found that the voxels in the AC, but not the HC, is able to decode learnt complex auditory stimuli over the course of an experiment, showing that the AC activity may show specificity for stimulus type (Kumar et al., 2014). The AC and IFG can also successfully decode whether a low or high pitched pure tone is being held in mind during the maintenance phase of an AuM task, albeit with a low accuracy (~55%) (Kumar et al., 2016). The IFG has been noted by other work to be activated in the maintenance of sounds that can be rehearsed (Koelsch et al., 2009).

Recently developed methods including representational similarity analysis (RSA) have allowed researchers to link brain activity and behavioural measurement across different modalities (Kriegeskorte et al., 2008). For example, this method can allow researchers to abstract away from comparing absolute brain activity in response to a particular stimuli to comparing how patterns of activity may differ between brain regions in response to specific stimuli. In the case of AuM, one can test if different regions show similar activity for distinguishing sounds themselves or whether the patterns are related to the behavioural result in a given trial. In this chapter, patterns of the voxels in the AC, HC and IFG were compared to examine whether activity was more similar when a pure-tone or AM sound was held in mind and also if there were

regional differences that better related a particular region to a more accurate result for a AuM experimental trial.

The objectives of this study were to assess:

1. brain activity during the maintenance phase of the AuM task across the ROIs of the AC, HC or IFG compared to a control task.
2. activity patterns in either ROI were better representative of the type of sound presented (pure-tone or AM white noise) or the trial error (accuracy of the parameter response compared to probed stimulus).

7.2. Methods

This study was conducted at the Wellcome Centre for Human Neuroimaging centre with general ethics approved by University College London to cover low-risk fMRI experiments of healthy human cognition (1825/003).

7.2.1. Participants

20 participants (14 female) were recruited through *www.callforparticipants.com* and the Wellcome Centre for Human Neuroimaging centre monthly newsletter. Participants were excluded if they had any active neurological or psychiatric medical condition or if they had any contraindications to fMRI scanning.

7.2.2. Experimental Stimuli

The AuM task used in the previous chapters was adapted for fMRI compatibility. The behavioural experiment was coded in MATLAB 2022b and presented using PsychToolbox. The task consisted of 36 trials that were divided into 24 interleaved trials measuring frequency precision and AM rate precision. Following this, there were 12 vigilance trials that required participants to identify if they had seen a red number amongst a stream of single digits displayed on the screen. This formed the control trial that would provide fMRI data to be used as a baseline contrast against the maintenance period from the auditory trials. The details of a generic auditory precision trial and a vigilance trial are shown in figure 7.1.

A trial measuring AuM precision was structured in the following way. Participants were first played a pure tone between 440 to 880 Hz (drawn from a uniform distribution) for 0.5 seconds and were asked to keep this sound in mind for three seconds. Whilst this sound was kept in mind, a stream of six single digits was displayed on the screen for 0.5 seconds each. 50% of the trials had a red number in the 5th or 6th position, whilst the rest of the numbers were white. After this period, there was a ten second interval where participants had to 'find the sound' on a horizontal scale as in the previous sections. The trial could be progressed before 10 seconds had elapsed if they were happy with their response. Participants used a right-hand keypad with four buttons to navigate on the scale and make their choices. An AM matching trial followed along the same structure with sound parameters drawn from a uniform distribution between 5 and 15 Hz.

As with the AuM precision trials, the vigilance trials had either a pure tone or an AM white noise sound played at the beginning but participants had to ignore this sound and focus on the stream of numbers being presented on the screen. They had to note if a red number was present and press the red button on the keypad at the end of the trial. If there was no red number present they were instructed to press the green button. The main difference in these trials was that at the end of the number stream participants had three seconds to make a binary response on whether they had seen a red number or not. Participants were given three seconds for this, which from pilot studies allowed responses to be made comfortably. To allow an independent estimation of the haemodynamic response to each condition a 3 to 5 second jitter was added after the response phase of each trial.

7.2.3. Procedure and Experimental Design

All participants attended a testing session that lasted 1.5 hours. In the first 30 minutes, participants underwent a consenting procedure and took part in a familiarisation process where they performed the AuM task once on a desktop computer. After completing this step participants were prepared for their MR scanning session. The order of MR sequences was the following: localiser, AuM Task Run 1, AuM Task Run 2, Field Map acquisition sequences, AuM Task Run 3, AuM Task Run 4 and a T1-weighted structural MPRAGE scan.

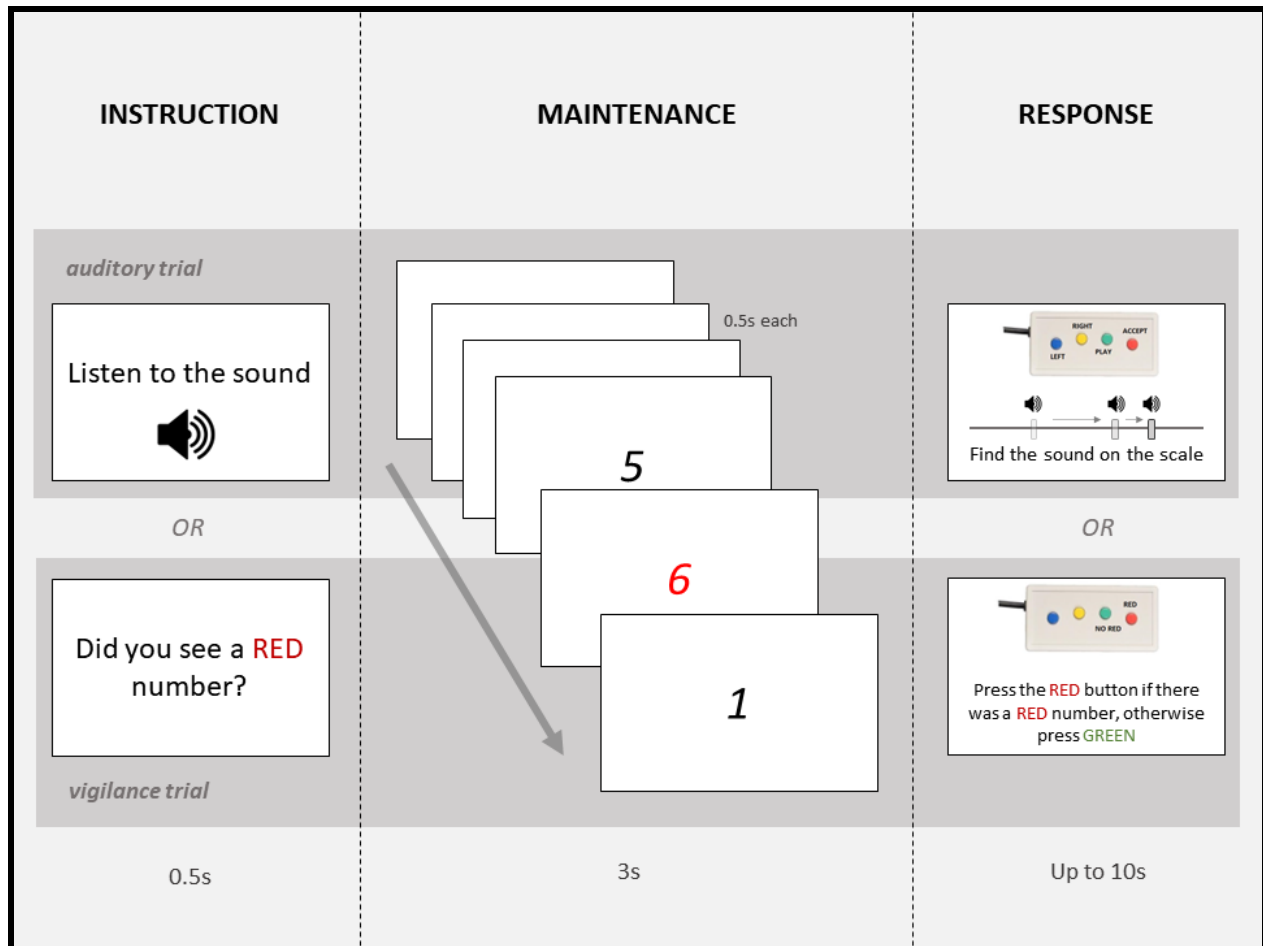

Figure 7.1. An experimental trial in the fMRI auditory memory task. Each trial consisted of an instruction at the beginning, a maintenance phase and then a response phase. Frequency-matching and AM rate matching trials were interleaved for the first 24 trials. A participant heard a sound played at a certain parameter, then they were asked to keep this sound in mind and ignore the numbers presented on the screen. When they saw a response screen, they moved a vertical bar on a horizontal scale and ‘found’ the original sound. They had to play a sound at a location on the scale and compare the sound they heard to the one presented in the instruction phase. They could make choices until they ‘found’ the sound or 10 seconds had elapsed. In the depiction, the participant makes two choices (from left to right) before making a final choice shown in the opaque bar. The sound icon is presented whenever a sound is played in the trial. For the vigilance trial, participants ignored the sound that was played initially but focused on the numbers presented on the screen. When the response phase was reached they made a choice depending on whether a red number was presented in the set. 12 vigilance trials were presented after the auditory trials. All auditory trials and vigilance trials constituted one run in the fMRI experiment.

7.2.4. *Functional imaging Data Collection*

All imaging data were collected on a Siemens 3T PENTA head-only MRI scanner at the Wellcome Centre for Human Neuroimaging at University College London, UK. Task fMRI images were acquired using continuous 3D Echo Planar Imaging of the whole brain with a TR of 1.1s, TE of 15.85ms, flip angle of 15°, isotropic voxel size of 2mm. As matching for each trial was self paced the number of total volumes varied. The mean time taken for one run was ~400s. Fieldmap images for distortion correction were acquired at two different echo times along with a phase difference sequence. The structural T1-weighted MPRAGE sequence was acquired with an isotropic voxel size of 1mm.

7.2.5. *Preprocessing*

Functional magnetic resonance imaging (fMRI) data were preprocessed using fMRIPrep (version 23.1.1), an NIAK-based pipeline for fMRI data preprocessing (Esteban et al., 2019). This pipeline employs a robust and reproducible framework for performing anatomical and functional preprocessing, while minimising user intervention. Anatomical images were first corrected for intensity non-uniformity using N4BiasFieldCorrection from ANTs software, followed by skull-stripping. Next, the resulting brain mask was refined with a combination of ANTs and FreeSurfer tools. The anatomical image was then segmented into tissue classes (GM, WM, and CSF) using the Atropos tool. Functional images were motion corrected with MCFLIRT from FSL and co-registered to the anatomical image using boundary-based registration with 9 degrees of freedom. Images were then normalised to the standard MNI152 template (2mm isotropic resolution) using nonlinear registration with ANTs. Spatial smoothing with a 6mm full-width at half-maximum Gaussian kernel was applied. Finally, motion parameters were visually inspected for excessive movement artefact and three participants' data were removed from subsequent analyses.

7.2.6. *Univariate Analysis*

fMRI data were analysed using the NiLearn module in Python 3.10. A general linear model (GLM) was used for statistical analysis and the design matrix consisted of functions encoding

the onset of the maintenance period and duration (3 seconds) convolved with the haemodynamic response function from the SPM software package. The design matrix also included translational and rotational motion regressors of no interest as well as white matter signal, global signal and framewise displacement. Anatomical component based noise correction methods were also used to regress effects of physiological fluctuations on the BOLD signal as this method has been shown to be superior to traditionally used methods and does not require external monitoring of heart rate and breathing (Behzadi et al., 2007).

After estimation of the GLM for each individual participant, parameter contrast maps using z-scores were created subtracting the effects of frequency-matching and AM rate-matching trials from the maintenance period of the vigilance trials in order to isolate BOLD signal specific for mental maintenance the respective sound stimuli. Second-level modelling was then performed using age and sex as regressors. Given the prior hypotheses about specific brain regions supporting AuM precision, HC, AC and IFG ROIs were created using the Harvard-Oxford Atlas (Fischl et al., 2004, 2002). Z-scores for brain activity were then compared in each region for frequency trial sound maintenance and AM rate trial sound maintenance using parametric statistics.

7.2.7. Representational Similarity Analysis

RSA was used to investigate the neural patterns associated with behavioural outcomes of the AuM task on a trial-by-trial basis using the SciPy module in Python 3.10. To create beta series parameter estimates for the maintenance period for each trial, the Least Squares All method was employed (Mumford et al., 2012). For each individual event, a separate GLM was specified and the event of interest was modelled with the haemodynamic response function. This way, the maintenance period for each trial yielded a separate beta value for every voxel in the brain, indicating the strength of activation for that specific event relative to all others. The BOLD signal from the aforementioned ROIs were extracted and then vectorised for further analysis.

Behavioural responses during the task were categorised into two distinct classes: 'hit' and 'miss'. A 'hit' refers to instances where participants' trial error was within two standard deviations of all their responses for a given sound stimulus type, whereas a 'miss' was any response

outside this range. This allowed association between the beta series measures extracted from each ROI and a binary behavioural result.

Pairwise BOLD signal pattern similarities with each brain region was computed using a Pearson's correlation metric. This metric was then applied to calculate similarities between BOLD signal patterns corresponding to the 'hit' and 'miss' conditions. The analysis proceeded in two main steps. Firstly, for each brain region, the similarity of activity patterns was assessed for both 'hit' and 'miss' conditions separately. A permutation-based approach was used to test if the observed pattern similarities were significantly greater than what would be expected by chance. Secondly, The differential activity between 'hit' and 'miss' conditions was then examined to assess whether the difference in representational patterns for 'hits' versus 'misses' was statistically significant in each ROI.

7.3. Results

7.3.1. Behavioural Data Analysis

AuM precision was compared outside (run 0) and inside the scanner (runs 1-4). There were no significant differences in mean AuM precision scores for frequency ($T(38) = 1.15$, $p = 0.264$, $BF = 0.42$) or AM rate ($T(38) = -0.52$, $p = 0.606$, $BF = 0.27$) for both conditions, despite scanner noise. Frequency precision was higher than AM rate precision ($T(38) = 7.80$, $p < 0.001$, $BF > 1000$) as has been noted previously (Lad et al., 2021).

7.3.2. Univariate fMRI Analysis

Significant differences were observed for the contrast maps between the maintenance period for frequency stimuli between the HC and IFG ($T(32) = 2.94$, $p = 0.006$, $BF = 7.5$) (Figure 7.2A). However, there were no differences between HC and AC ($T(32) = 1.92$, $p = 0.064$, $BF = 1.3$) or the AC and IFG ($T(32) = 0.01$, $p = 0.993$, $BF = 0.3$). Significant differences were observed between the contrast maps between the maintenance period for AM white noise stimuli between the HC and AC ($T(32) = 2.56$, $p = 0.016$, $BF = 3.6$), and the HC and IFG ($T(32) = 3.38$, $p =$

0.002, BF = 17.9) (Figure 7.2B). However, there were no differences between AC and IFG (T(32) = -0.72, p = 0.476, BF = 0.4).

7.3.3. *Representational Similarity Analysis*

All three regions showed differences in similarity metrics for 'hits' and 'misses', across both trial types (for both sound stimuli) after comparisons with permuted samples. The HC showed higher similarity metrics for 'hits' (T(32) = 4.3, p < 0.001, BF > 100) and 'misses' (T(32) = 5.1, p < 0.001, BF > 1000) along with the AC for 'hits' (T(32) = 5.1, p < 0.001, BF > 1000) and 'misses' (T(32) = 4.3, p < 0.001, BF > 100) and the IFG for 'hits' (T(32) = 5.5, p < 0.001, BF > 3000) and 'misses' (T(32) = 4.8, p < 0.001, BF > 400).

This was also the case when the trials were stratified according to trial type based on the sound stimuli encountered on a given trial. For frequency-matching AuM trials, the HC showed higher similarity metrics for 'hits' (T(32) = 6.74, p < 0.001, BF > 9000) and 'misses' (T(32) = 3.54, p = 0.001, BF = 26) as compared to permuted samples. Similarly, the AC showed higher similarity metrics for 'hits' (T(32) = 5.76, p < 0.001, BF > 6000) and 'misses' (T(32) = 3.02, p = 0.005, BF = 8.7) and so did the IFG voxels for 'hits' (T(32) = 6.63, p < 0.001, BF > 9000) and 'misses' (T(32) = 3.62, p < 0.001, BF = 31). For AM rate-matching AuM trials, the HC showed higher similarity metrics for 'hits' (T(32) = 2.27, p < 0.05, BF = 2.2) and 'misses' (T(32) = 4.90, p = 0.001, BF > 400) as compared to permuted samples. Similarly, the AC showed higher similarity metrics for 'hits' (T(32) = 3.50, p = 0.005, BF = 19) and 'misses' (T(32) = 9.36, p < 0.001, BF > 9000) and so did the IFG voxels for 'hits' (T(32) = 3.50, p = 0.006, BF = 19) and 'misses' (T(32) = 7.83, p < 0.001, BF > 3000).

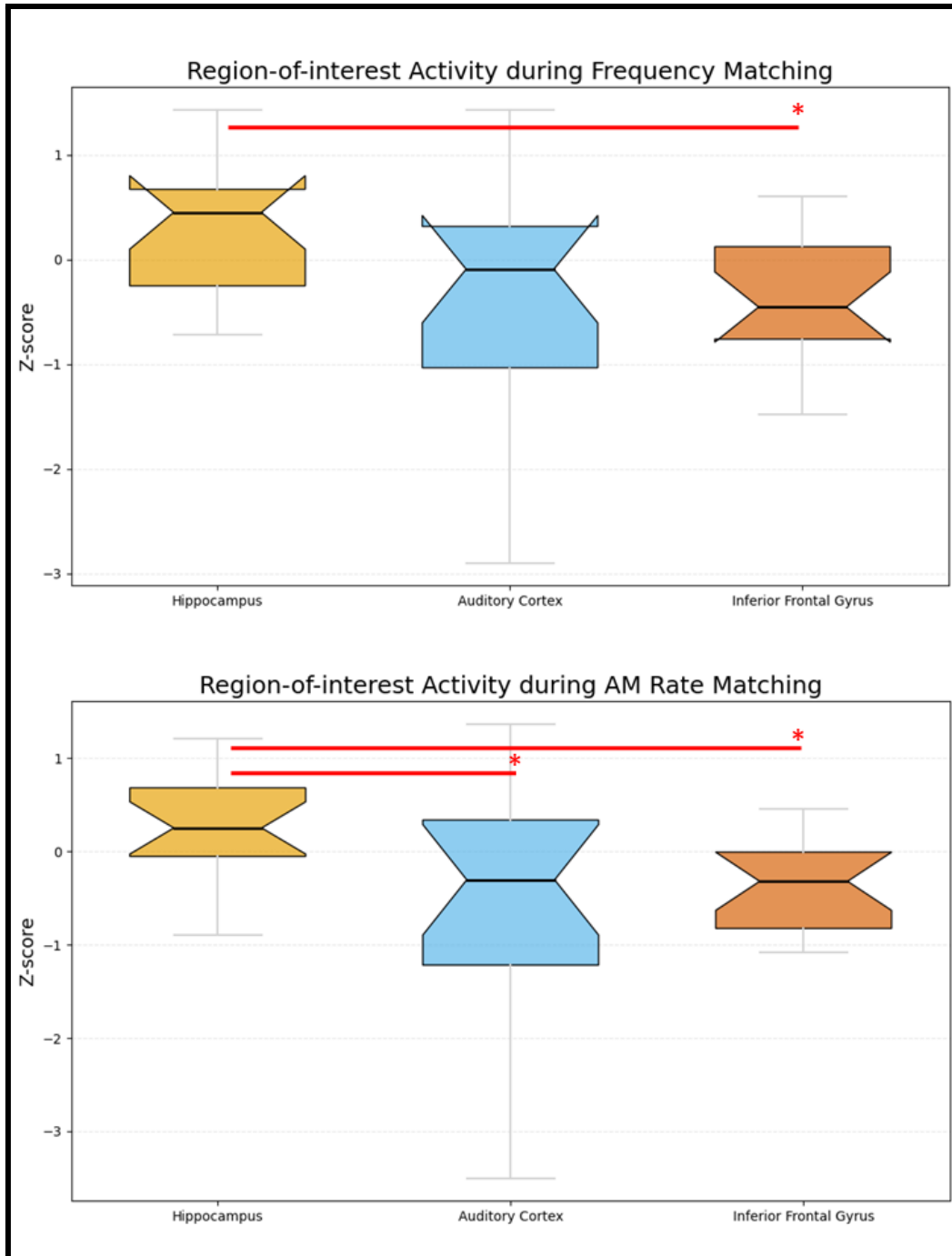

Figure 7.2. Region of interest based activity during the maintenance phase of the auditory memory task. The top pane shows z-scores for BOLD activity in the hippocampus (yellow), auditory cortex (blue) and inferior frontal gyrus (orange) during the maintenance phase for the auditory memory task during frequency matching. The bottom pane shows results for AM rate matching condition. There is significantly greater activity in the hippocampus during this period for frequency as compared to the inferior frontal gyrus. There is significantly greater activity in the hippocampus during the AM rate matching task as compared to the auditory cortex and inferior frontal gyrus. Red asterisks indicate significant results.

Similarity scores were compared across the ROIs to see if there were significant differences across 'hit' and 'miss' conditions for the two different sound stimuli. There were greater differences in similarity scores in the voxels from the HC as compared to the AC ($T(32) = 2.86$, $p = 0.007$, $BF = 6.4$) for frequency-matching trials but not compared to IFG ($T(32) = 1.39$, $p = 0.174$, $BF = 0.69$). There were no such differences observed for AM rate-matching trials between the HC and AC ($T(32) = 0.57$, $p = 0.569$, $BF = 0.4$) or the HC and IFG ($T(32) = -0.44$, $p = 0.662$, $BF = 0.4$). There were also no differences between AC and IFG for frequency-matching trials ($T(32) = -1.73$, $p = 0.094$, $BF = 1.0$) and AM-rate matching ($T(32) = -1.54$, $p = 0.137$, $BF = 0.9$) ones.

7.4. Discussion

The study described in this chapter showed how fMRI can provide a window into AuM processes in order to understand brain activity related to behaviour on a trial-by-trial basis. The key findings from the study were that HC activity was greater during the maintenance of auditory stimuli consisting of pure tones and AM white noise stimuli, compared to the IFG, and that the patterns of activity in the HC showed greater similarity during this phase for frequency-matching trials where the subsequent behavioural responses showed greater precision as compared to the AC, suggesting a role for the HC in AuM for frequency precision. This study advances from previous work that identified the AC, HC and IFG as key nodes for AuM by linking brain activity to behaviour.

7.4.1. Maintenance Activity Corresponding to Memory Precision

This experiment used contrast maps generated by subtracting the BOLD activity in the maintenance period of the vigilance condition from that of the two AuM conditions separately. Brain activity in the default mode network, a brain system closely connected with the HC, is known to be least active during tasks requiring sustained attention and allows for identification for BOLD signals specific to AuM (Raichle and Snyder, 2007). Therefore, this study design was implemented to isolate cognitive processes supporting the maintenance of sound after potentially accounting for brain regions supporting attentional processes. It was observed that

the HC had greater activity than the IFG for pure tone maintenance and greater activity than the AC and the IFG for AM white noise stimuli.

The greater HC activity during the maintenance period could correspond to processes supporting the memory for sounds in the absence of their stimuli as seen in previous work (Kumar et al., 2016). There is growing evidence from direct neurophysiological recordings of the HC that this 'activity silent' working memory does involve HC computations specific to memory so the increased BOLD signal may be directly linked to performance (Beukers et al., 2021). It is also possible that the HC may simply track sound features in mind without explicitly contributing to high-level precision in the behavioural task. However, controlling for attention between the AuM and vigilance condition is difficult as it cannot be measured objectively and the methodological contrast in the GLM may not have captured these processes accurately. Attention is known to have a complex effect on BOLD activity in the HC and further work is needed to clarify its effect in this task (Aly and Turk-Browne, 2016). There is also an underlying assumption with the analysis that cognitive processes can be 'subtracted' out through GLM contrasts and the results reflect regions responsible for those other cognitive functions. There are also other modes of communication between brain regions, such as oscillatory activity and sparse coding that may not be captured by the BOLD activity in this study (Kahana, 2006; Olshausen and Field, 1996).

7.4.2. Multi-voxel Patterns Relating to Auditory Memory Precision

The AC and HC have both been implicated with showing BOLD activity that is specific to stimulus features. Multivariate methods have been used to show that AC activity during the maintenance phase of an AuM task can have greater decoding activity for pitch categories than chance (Czoschke et al., 2021; Kumar et al., 2016; Linke et al., 2011). In one study, the AC ROI, which included Heschl's gyrus, planum temporale and the posterior division of the superior temporal gyrus, showed specificity to both spatial and non-spatial features (Czoschke et al., 2021). In other work, the AC showed BOLD activity to frequency-based stimuli and AM rate features (between 4 to 25Hz), although activity to the latter was invariant to the AM rate (Sohoglu et al., 2020). The parietal cortex showed better decodability for specific rates. The HC has not been widely studied as an ROI for AuM, however, one study did not find a higher percentage accuracy for classifying high vs. low pure tones than chance (Kumar et al., 2016).

This study used RSA to investigate whether voxel BOLD activity patterns in the AC, HC and IFG contained information about behavioural performance in a given trial. Studies have not considered this technique when studying AuM before therefore direct comparisons can only be drawn from the visual literature. Previous fMRI work with RSA and visual stimuli has shown that behavioural memory strength can be related to activation patterns in the medial temporal lobe (Davis et al., 2014). I found that all three ROIs had higher similarity metrics than chance for 'hits' and 'misses' suggesting that these regions contain information regarding the behavioural responses. However, only the HC had higher similarity for 'hits' rather than 'misses' for frequency-based matching AuM trials. It has been suggested that higher similarity metrics between memory representations of the same stimulus supports better subsequent memory (Heinen et al., 2023). Although the exact reasons for the difference between the differences in the HC for pure tones and the AM white noise stimuli are unclear, one reason may relate to the ease at which each stimuli can be kept in mind. Pure-tones are readily encountered in daily life but AM white noise stimuli are not as frequent. Some studies have suggested that increasing the familiarity of stimuli resulted in greater HC activation (Mayes et al., 2019).

7.4.3. Limitations and Future Directions

There are certain limitations of this study that may have to be considered when interpreting the findings presented in this chapter. Firstly, there was a relatively small sample size that was used for the study. Recent studies have shown that fMRI studies may benefit from much larger cohorts and longer testing times (Marek et al., 2022). However, one of the main aims of this work was to assess if there was applicability in the AuM task used in previous chapters to neuroimaging with fMRI which was conducted successfully. Another limitation is that in the analysis used there is no direct mechanistic link between BOLD activation due to cognitive processes in the brain and behaviour (Kullmann, 2020). This makes it difficult to make causal claims due to certain task conditions. A mitigation for this is that techniques such as RSA have been successfully applied to abstract BOLD activity in a form that can relate stimuli to behaviour (Heinen et al., 2023). Further work is needed to see if best practice methods for neuroimaging predictive analysis with a larger dataset, in terms of using k-fold cross-validation, multiple measures of prediction accuracy and analysis on a test set can be used to assess the generalisability of the RSA models (Poldrack et al., 2020).

This work provides an opportunity for future immediate research to address certain questions. Previous work has used longer maintenance periods for the AuM task and shown HC activity identified through whole brain methods (Kumar et al., 2016). There was a small time window for each trial (3 seconds) that was used for this study. A further study with longer maintenance periods could evaluate whether activity in the early or late periods, when HC activity was greatest, is better related to behavioural performance and the multivariate RSA metrics improve as a result. Whole-brain multivariate methods can then be used for hypothesis-free validation of neural substrates that may have better predictive power (Baldassarre et al., 2017; Bzdok et al., 2019). These methods have not been utilised to investigate AuM function yet. Studies using visual stimuli have shown that activity in different hippocampal subregions changes depending on the episodic context, processes which are key for vivid recollection (Dimsdale-Zucker et al., 2018). 7T fMRI offers an opportunity to explore this question with auditory stimuli. Finally, whether HC activity represents domain general specificity to behavioural performance or if this is modality specific or stimulus-dependent is unknown and needs to be explored further.

8. Summary and Conclusions

8.1. Main findings

The work carried out in this thesis was designed to assess novel auditory tests as markers of cognitive function in AD. A variety of methods were used to show this including epidemiological data from existing databases, a study of behavioural markers of auditory cognition in ageing and cognitive impairment due to AD, multi-model imaging assessed grey and white matter in people with and without cognitive impairment due to AD, and with task-based fMRI in healthy participants. The main findings in each chapter are presented below:

- Chapter 3 highlighted the importance of using objective markers of central auditory function when assessing dementia risk. The ADNI cohort provides a rich dataset where demographic, clinical, neuroimaging and biochemical measures can be studied alongside those of sensory loss like hearing loss. Despite the comprehensive data collection that takes place in the study, hearing loss is only measured as a subjective measure that is coded for its presence or absence. Furthermore, free-text data must also be screened to obtain information in this realm. The study found no associations between subjective hearing loss and neuropsychological, neuroimaging and biochemical metrics of AD.
- The study described in chapter 4 aimed to evaluate predictors of SiN perception ability. Two different SiN measures were compared based on demographic, peripheral hearing thresholds and AuM measures for AM rate and frequency. AuM precision for AM rate was a crucial factor when SiN occurred over several seconds (greater than 10) as opposed to a few seconds. The study highlighted how everyday hearing ability is supported by cognitive processes that are involved in memory function as well as demographic factors. Specifically, the involvement of AuM precision for AM rate points to an auditory cognitive framework that is involved in processing the temporal envelope of speech over seconds for successful SiN perception.
- Chapter 5 presented a study that described how SiN perception ability and AuM precision for AM rate is lower in people with cognitive impairment due to AD. These abilities declined steadily across groups, from 'Cognitively Normal' individuals to MCI-AD

to AD dementia participants. Both of these measures may be useful markers of early cognitive decline in people with AD. They may also be useful in assessing non-neurodegenerative cognitive disorders affecting memory function, as illustrated by the case study of the patient with FCD.

- The study in chapter 6 was designed to evaluate whether structural changes in the brain across the AD spectrum were associated with changes in SiN perception over several seconds and AuM precision for AM rate. The findings were that the latter was associated with grey matter atrophy and cortical thinning in AD signature regions, the MTL and regions associated with auditory processing. SiN performance was also related to measures of white tract integrity, in the corpus callosum and cingulum bundles, measured as a decrease in QA in these regions.
- The last study presented in chapter 7 showed how using the same AuM task as in the previous chapters can be used to show neuroscientifically that medial temporal lobe structures such as the HC may play a key part in task performance. Greater activity was observed in the HC during sound maintenance and multivariate pattern analysis with RSA showed that BOLD activity was more similar with more accurate responses across the experiment for frequency-based stimuli.

The collection of studies described above show that auditory cognition via the medial temporal lobe may be a critical pathway that links hearing loss and AD dementia. This is evidenced by neuropsychological and neuroimaging work carried out in this thesis. The next sections discuss the applicability of these results and how some immediate questions that arise from this thesis can be tackled with future research.

8.2. Molecular biomarkers vs. cognitive realities in Alzheimer's disease

Further work is needed to establish whether auditory cognition that is relevant to AD is better associated with neuropathological changes in the brain or the cognitive impairment that is a manifestation of these alterations. Brain Tau accumulation measured *in-vivo* with PET tracers is associated with memory scores in cross-sectional and longitudinal studies (Kwan et al., 2023; Lowe et al., 2019). However, the lifetime risk of AD dementia using biomarkers reduces with age in the very old. Whereas the risk of AD dementia after testing positive for amyloid is around 30% for a 65 year-old, it reduced to below 10% at 90 (Brookmeyer and Abdalla, 2018). Therefore,

people with high levels of neuropathology in their brains may still be cognitively normal. Studies with hearing measures are lacking in this field. However, some work has identified that hearing loss, as measured by the PTA, is associated with amyloid binding in older adults but not in the very old (90+ years of age) (Hooft et al., 2023).

An immediate next step to clarify whether SiN and AuM precision are related to neuropathology in AD would be to test fluid biomarkers in all participants. Amyloid ratios and pTau-181 are becoming more accessible to memory clinic doctors currently and although tests in the UK require a lumbar puncture in order to acquire cerebrospinal fluid to test for these markers, plasma biomarkers are on the horizon. pTau-217 plasma biomarkers have been consistently shown to outperform other tests in the diagnosis of AD and prediction of conversion to AD dementia from a MCI-AD state but are not widely available as of yet in the UK (Janelidze et al., 2023). This test and others may allow for accurate classification of amyloid and Tau status across the AD continuum (Barthélemy et al., 2023). APOE4 subtyping is another crucial element of AD research where group-level cognitive, neuroimaging and biochemical differences can be detected in participants at risk of AD dementia (Belloy et al., 2019). Future data collection in the AudCog study will include this test as accounting for its effects may allow better separation of the participants at a group-level. Some researchers suggest that APOE4-related sporadic AD may be a different form of AD altogether which further supports its inclusion (Frisoni et al., 2022).

Chapters 4 and 5 described studies using specific central hearing tests to assess whether auditory cognition was related to cognitive impairment in AD dementia but, like fluid biomarker tests described above, these could be refined or adapted. For example, researchers have used an adaptation of the DiN task used in this thesis where numbers presented to each ear are different and participants have to focus on digits presented to a particular ear (Utoomprurkporn et al., 2020). People who have a diagnosis of AD show a right-ear advantage with this task, which increases with the severity of cognitive impairment. It is not known how performance in the DiN task used in this study compares with that from the AudCog study. PTA thresholds within the clinically measured range of 250 Hz to 8 kHz are commonly used to assess hearing but there is emerging evidence suggesting extended high-frequency measures above this threshold may be better related to SiN perception ability (Motlagh Zadeh et al., 2019). Finally, a combination of neurophysiological measures to speech and behavioural measures have also been successfully applied to research in the field of predicting SiN perception ability

(Parthasarathy et al., 2020). How these measures relate to cognitive impairment in AD or AD risk is unclear.

8.3. Auditory Cognition and resilience against dementia

Auditory cognition may also be better associated with factors associated with resilience against dementia. Although medial temporal lobe brain changes have been traditionally associated with AD dementia, a favourable structural profile of the medial temporal lobe is also associated with 'successful' ageing (Yang et al., 2016). Minimal brain changes to these regions are also associated with better cognition in very old cognitively unimpaired adults (Nyberg et al., 2012). The complex relationship between neuropathology, atrophy, cognitive impairment and functional impairment in AD has not been fully elucidated and auditory cognitive measures will have to be studied alongside measures from each domain in order to clarify this relationship.

Apart from having potential links with neuropsychological, neuroimaging and resilience against dementia, auditory cognitive measures could be related to the individual elements of resilience such as brain maintenance, cognitive reserve, and brain reserve (Stern et al., 2020). Brain maintenance refers to the preservation of brain health through lifestyle choices and interventions that protect and nurture the brain. Poor central or peripheral hearing may cause strain on cognitive resources and this may have direct effects on reducing resilience. There may be indirect effects through social withdrawal and isolation which are independent risk factors for dementia (Livingston et al., 2020). Cognitive reserve refers to an individual's capacity to maintain cognitive function in the face of brain ageing or neurodegenerative diseases such as dementia. This concept suggests that people with higher cognitive reserve may be more resilient against the effects of dementia, as they can draw on their increased cognitive resources to compensate for declining brain function. Key contributors to this include education, occupational complexity and lifelong learning. Better hearing would promote these activities. Brain reserve refers to the structural and functional capacity of the brain that can be called upon in times of cognitive decline or disease. Unlike cognitive reserve, which emphasises the ability to compensate for brain damage, brain reserve focuses on the presence of additional brain resources that can help buffer against cognitive decline. This is primarily determined by genetics and neuropathology that can impact on the structural morphology of the cortex. Chapter 6

described some of the brain changes that are related to auditory cognition in AD. Some of these changes may be related to brain reserve rather than the AD disease process.

Environmental and psychological factors may also have a strong influence on the relationship between hearing loss and dementia. It is well evidenced that socioeconomic disadvantage is associated with greater risk of dementia and is associated with a greater severity of neuropathological changes, independent of other indirect influences (Hamilton et al., 2021). Whether this impact occurs via a reduction of resilience against dementia or other indirect mechanisms is unclear. Hearing loss can contribute to social isolation and low mood by creating barriers to communication and social interaction, which are essential components of psychological well-being. Several studies have investigated these connections, providing valuable insights into the implications of hearing loss on mental health and social well-being. Hearing loss is significantly associated with greater odds of social isolation in older adults, particularly among those who do not use hearing aids (Mick et al., 2014). Another study found a strong association between hearing loss, cognition and depression among older adults (Jayakody et al., 2018). Other work has demonstrated that hearing loss is independently associated with an increased risk of loneliness, particularly in non-hearing aid users and men (Pronk et al., 2011). The study highlights the importance of addressing hearing loss as a modifiable risk factor for loneliness and social isolation, which in turn may lead to dementia.

References

- Acosta-Cabrero, J., Nestor, P.J., 2014. Diffusion tensor imaging in Alzheimer's disease: insights into the limbic-diencephalic network and methodological considerations. *Frontiers in Aging Neuroscience* 6.
- Adluru, N., Destiche, D.J., Lu, S.Y.-F., Doran, S.T., Birdsill, A.C., Melah, K.E., Okonkwo, O.C., Alexander, A.L., Dowling, N.M., Johnson, S.C., Sager, M.A., Bendlin, B.B., 2014. White matter microstructure in late middle-age: Effects of apolipoprotein E4 and parental family history of Alzheimer's disease. *Neuroimage Clin* 4, 730–742. <https://doi.org/10.1016/j.nicl.2014.04.008>
- Akeroyd, M.A., 2008. Are individual differences in speech reception related to individual differences in cognitive ability? A survey of twenty experimental studies with normal and hearing-impaired adults. *Int J Audiol* 47 Suppl 2, S53-71. <https://doi.org/10.1080/14992020802301142>
- Alm, K.H., Bakker, A., 2019. Relationships Between Diffusion Tensor Imaging and Cerebrospinal Fluid Metrics in Early Stages of the Alzheimer's Disease Continuum. *J Alzheimers Dis* 70, 965–981. <https://doi.org/10.3233/JAD-181210>
- Aly, M., Turk-Browne, N.B., 2016. Attention Stabilizes Representations in the Human Hippocampus. *Cereb Cortex* 26, 783–796. <https://doi.org/10.1093/cercor/bhv041>
- Apostolova, L.G., Mosconi, L., Thompson, P.M., Green, A.E., Hwang, K.S., Ramirez, A., Mistur, R., Tsui, W.H., de Leon, M.J., 2010. Subregional hippocampal atrophy predicts Alzheimer's dementia in the cognitively normal. *Neurobiol Aging* 31, 1077–1088. <https://doi.org/10.1016/j.neurobiolaging.2008.08.008>
- Argyropoulos, G.P.D., Dell'Acqua, C., Butler, E., Loane, C., Roca-Fernandez, A., Almozal, A., Drummond, N., Lage-Martinez, C., Cooper, E., Henson, R.N., Butler, C.R., 2022. Functional Specialization of the Medial Temporal Lobes in Human Recognition Memory: Dissociating Effects of Hippocampal versus Parahippocampal Damage. *Cerebral Cortex* 32, 1637–1652. <https://doi.org/10.1093/cercor/bhab290>
- Armstrong, N.M., An, Y., Doshi, J., Erus, G., Ferrucci, L., Davatzikos, C., Deal, J.A., Lin, F.R., Resnick, S.M., 2019. Association of Midlife Hearing Impairment With Late-Life Temporal Lobe Volume Loss. *JAMA Otolaryngol Head Neck Surg*. <https://doi.org/10.1001/jamaoto.2019.1610>
- Aschenbrenner, A.J., Gordon, B.A., Benzinger, T.L.S., Morris, J.C., Hassenstab, J.J., 2018. Influence of tau PET, amyloid PET, and hippocampal volume on cognition in Alzheimer disease. *Neurology* 91, e859–e866. <https://doi.org/10.1212/WNL.0000000000006075>
- Avants, B.B., Epstein, C.L., Grossman, M., Gee, J.C., 2008. Symmetric diffeomorphic image registration with cross-correlation: evaluating automated labeling of elderly and neurodegenerative brain. *Med Image Anal* 12, 26–41. <https://doi.org/10.1016/j.media.2007.06.004>
- Bäckman, L., Small, B.J., Fratiglioni, L., 2001. Stability of the preclinical episodic memory deficit in Alzheimer's disease. *Brain* 124, 96–102. <https://doi.org/10.1093/brain/124.1.96>
- Bakkour, A., Morris, J.C., Dickerson, B.C., 2009. The cortical signature of prodromal AD. *Neurology* 72, 1048–1055. <https://doi.org/10.1212/01.wnl.0000340981.97664.2f>
- Bakkour, A., Morris, J.C., Wolk, D.A., Dickerson, B.C., 2013. The effects of aging and Alzheimer's disease on cerebral cortical anatomy: Specificity and differential relationships with cognition. *NeuroImage* 76, 332–344. <https://doi.org/10.1016/j.neuroimage.2013.02.059>
- Baldassarre, L., Pontil, M., Mourão-Miranda, J., 2017. Sparsity Is Better with Stability: Combining Accuracy and Stability for Model Selection in Brain Decoding. *Front Neurosci*

- 11, 62. <https://doi.org/10.3389/fnins.2017.00062>
- Ball, H.A., McWhirter, L., Ballard, C., Bhome, R., Blackburn, D.J., Edwards, M.J., Fleming, S.M., Fox, N.C., Howard, R., Huntley, J., Isaacs, J.D., Lerner, A.J., Nicholson, T.R., Pennington, C.M., Poole, N., Price, G., Price, J.P., Reuber, M., Ritchie, C., Rossor, M.N., Schott, J.M., Teodoro, T., Venneri, A., Stone, J., Carson, A.J., 2020. Functional cognitive disorder: dementia's blind spot. *Brain* 143, 2895–2903. <https://doi.org/10.1093/brain/awaa224>
- Baloyannis, S.J., Mauroudis, I., Manolides, S.L., Manolides, L.S., 2009. Synaptic alterations in the medial geniculate bodies and the inferior colliculi in Alzheimer's disease: a Golgi and electron microscope study. *Acta Oto-Laryngologica* 129, 416–418. <https://doi.org/10.1080/00016480802579074>
- Banks, M.I., Krause, B.M., Berger, D.G., Campbell, D.I., Boes, A.D., Bruss, J.E., Kovach, C.K., Kawasaki, H., Steinschneider, M., Nourski, K.V., 2023. Functional geometry of auditory cortical resting state networks derived from intracranial electrophysiology. <https://doi.org/10.1101/2022.02.06.479292>
- Barense, M.D., Bussey, T.J., Lee, A.C.H., Rogers, T.T., Davies, R.R., Saksida, L.M., Murray, E.A., Graham, K.S., 2005. Functional specialization in the human medial temporal lobe. *J Neurosci* 25, 10239–10246. <https://doi.org/10.1523/JNEUROSCI.2704-05.2005>
- Barnes, J., Bartlett, J.W., van de Pol, L.A., Loy, C.T., Scahill, R.I., Frost, C., Thompson, P., Fox, N.C., 2009. A meta-analysis of hippocampal atrophy rates in Alzheimer's disease. *Neurobiol. Aging* 30, 1711–1723. <https://doi.org/10.1016/j.neurobiolaging.2008.01.010>
- Barthélemy, N.R., Mallipeddi, N., Moiseyev, P., Sato, C., Bateman, R.J., 2019. Tau Phosphorylation Rates Measured by Mass Spectrometry Differ in the Intracellular Brain vs. Extracellular Cerebrospinal Fluid Compartments and Are Differentially Affected by Alzheimer's Disease. *Front Aging Neurosci* 11, 121. <https://doi.org/10.3389/fnagi.2019.00121>
- Barthélemy, N.R., Saef, B., Li, Y., Gordon, B.A., He, Y., Horie, K., Stomrud, E., Salvadó, G., Janelidze, S., Sato, C., Ovod, V., Henson, R.L., Fagan, A.M., Benzinger, T.L.S., Xiong, C., Morris, J.C., Hansson, O., Bateman, R.J., Schindler, S.E., 2023. CSF tau phosphorylation occupancies at T217 and T205 represent improved biomarkers of amyloid and tau pathology in Alzheimer's disease. *Nat Aging* 3, 391–401. <https://doi.org/10.1038/s43587-023-00380-7>
- Behzadi, Y., Restom, K., Liu, J., Liu, T.T., 2007. A Component Based Noise Correction Method (CompCor) for BOLD and Perfusion Based fMRI. *Neuroimage* 37, 90–101. <https://doi.org/10.1016/j.neuroimage.2007.04.042>
- Bejanin, A., Schonhaut, D.R., La Joie, R., Kramer, J.H., Baker, S.L., Sosa, N., Ayakta, N., Cantwell, A., Janabi, M., Lauriola, M., O'Neil, J.P., Gorno-Tempini, M.L., Miller, Z.A., Rosen, H.J., Miller, B.L., Jagust, W.J., Rabinovici, G.D., 2017. Tau pathology and neurodegeneration contribute to cognitive impairment in Alzheimer's disease. *Brain* 140, 3286–3300. <https://doi.org/10.1093/brain/awx243>
- Belloy, M.E., Napolioni, V., Greicius, M.D., 2019. A Quarter Century of APOE and Alzheimer's Disease: Progress to Date and the Path Forward. *Neuron* 101, 820–838. <https://doi.org/10.1016/j.neuron.2019.01.056>
- Beukers, A.O., Buschman, T.J., Cohen, J.D., Norman, K.A., 2021. Is Activity Silent Working Memory Simply Episodic Memory? *Trends in Cognitive Sciences* 25, 284–293. <https://doi.org/10.1016/j.tics.2021.01.003>
- Bhome, R., McWilliams, A., Huntley, J.D., Fleming, S.M., Howard, R.J., 2019. Metacognition in functional cognitive disorder- a potential mechanism and treatment target. *Cogn Neuropsychiatry* 24, 311–321. <https://doi.org/10.1080/13546805.2019.1651708>
- Billig, A.J., Lad, M., Sedley, W., Griffiths, T.D., 2022. The hearing hippocampus. <https://doi.org/10.31234/osf.io/dqfyw>

- Binks, S.N.M., Klein, C.J., Waters, P., Pittock, S.J., Irani, S.R., 2018. LGI1, CASPR2 and related antibodies: a molecular evolution of the phenotypes. *J Neurol Neurosurg Psychiatry* 89, 526–534. <https://doi.org/10.1136/jnnp-2017-315720>
- Borders, A.A., Ranganath, C., Yonelinas, A.P., 2022. The hippocampus supports high-precision binding in visual working memory. *Hippocampus* 32, 217–230. <https://doi.org/10.1002/hipo.23401>
- Bordi, F., LeDoux, J.E., 1994. Response properties of single units in areas of rat auditory thalamus that project to the amygdala. *Exp Brain Res* 98, 261–274. <https://doi.org/10.1007/BF00228414>
- Bozzali, M., Falini, A., Franceschi, M., Cercignani, M., Zuffi, M., Scotti, G., Comi, G., Filippi, M., 2002. White matter damage in Alzheimer's disease assessed in vivo using diffusion tensor magnetic resonance imaging. *J Neurol Neurosurg Psychiatry* 72, 742–746. <https://doi.org/10.1136/jnnp.72.6.742>
- Braak, H., Braak, E., 1991. Neuropathological staging of Alzheimer-related changes. *Acta Neuropathol* 82, 239–259. <https://doi.org/10.1007/BF00308809>
- Brenowitz, W.D., Besser, L.M., Kukull, W.A., Keene, C.D., Glymour, M.M., Yaffe, K., 2020. Clinician-judged hearing impairment and associations with neuropathologic burden. *Neurology* 95, e1640–e1649. <https://doi.org/10.1212/WNL.00000000000010575>
- Brewster, K.K., Hu, M.-C., Wall, M.M., Brown, P.J., Zilcha-Mano, S., Roose, S.P., Stein, A., Golub, J.S., Rutherford, B.R., 2021. Age-Related Hearing Loss, Neuropsychological Performance, and Incident Dementia in Older Adults. *Journal of Alzheimer's Disease* 80, 855–864. <https://doi.org/10.3233/JAD-200908>
- Brookmeyer, R., Abdalla, N., 2018. Estimation of lifetime risks of Alzheimer's disease dementia using biomarkers for preclinical disease. *Alzheimers Dement* 14, 981–988. <https://doi.org/10.1016/j.jalz.2018.03.005>
- Bucholc, M., Bauermeister, S., Kaur, D., McClean, P.L., Todd, S., 2022. The impact of hearing impairment and hearing aid use on progression to mild cognitive impairment in cognitively healthy adults: An observational cohort study. *Alzheimer's & Dementia: Translational Research & Clinical Interventions* 8, e12248. <https://doi.org/10.1002/trc2.12248>
- Butler, C.R., Miller, T.D., Kaur, M.S., Baker, I.W., Boothroyd, G.D., Illman, N.A., Rosenthal, C.R., Vincent, A., Buckley, C.J., 2014. Persistent anterograde amnesia following limbic encephalitis associated with antibodies to the voltage-gated potassium channel complex. *J. Neurol. Neurosurg. Psychiatry* 85, 387–391. <https://doi.org/10.1136/jnnp-2013-306724>
- Bzdok, D., Nichols, T.E., Smith, S.M., 2019. Towards Algorithmic Analytics for Large-scale Datasets. *Nat Mach Intell* 1, 296–306. <https://doi.org/10.1038/s42256-019-0069-5>
- Caspary, D.M., Ling, L., Turner, J.G., Hughes, L.F., 2008. Inhibitory Neurotransmission, Plasticity and Aging in the Mammalian Central Auditory System. *J Exp Biol* 211, 1781–1791. <https://doi.org/10.1242/jeb.013581>
- Chait, M., Poeppel, D., Simon, J.Z., 2006. Neural Response Correlates of Detection of Monaurally and Binaurally Created Pitches in Humans. *Cerebral Cortex* 16, 835–848. <https://doi.org/10.1093/cercor/bhj027>
- Chen, G.-D., 2018. Hidden cochlear impairments. *Journal of Otology* 13, 37–43. <https://doi.org/10.1016/j.joto.2018.05.001>
- Chen, P., Ratcliff, G., Belle, S.H., Cauley, J.A., DeKosky, S.T., Ganguli, M., 2000. Cognitive tests that best discriminate between presymptomatic AD and those who remain nondemented. *Neurology* 55, 1847–1853. <https://doi.org/10.1212/WNL.55.12.1847>
- Chua, T.C., Wen, W., Slavin, M.J., Sachdev, P.S., 2008. Diffusion tensor imaging in mild cognitive impairment and Alzheimer's disease: a review. *Curr Opin Neurol* 21, 83–92. <https://doi.org/10.1097/WCO.0b013e3282f4594b>
- Ciric, R., Thompson, W.H., Lorenz, R., Goncalves, M., MacNicol, E.E., Markiewicz, C.J.,

- Halchenko, Y.O., Ghosh, S.S., Gorgolewski, K.J., Poldrack, R.A., Esteban, O., 2022. TemplateFlow: FAIR-sharing of multi-scale, multi-species brain models. *Nat Methods* 19, 1568–1571. <https://doi.org/10.1038/s41592-022-01681-2>
- Cohen, Y.E., Bennur, S., Christison-Lagay, K., Gifford, A., Tsunada, J., 2016. Functional Organization of the Ventral Auditory Pathway. *Adv Exp Med Biol* 894, 381–388. https://doi.org/10.1007/978-3-319-25474-6_40
- Cope, T.E., Baguley, D.M., Griffiths, T.D., 2015. The functional anatomy of central auditory processing. *Practical Neurology* 15, 302–308. <https://doi.org/10.1136/practneurol-2014-001073>
- Cramer, E.M., Huggins, W.H., 1958. Creation of Pitch through Binaural Interaction. *The Journal of the Acoustical Society of America* 30, 413–417. <https://doi.org/10.1121/1.1909628>
- Czoschke, S., Fischer, C., Bahador, T., Bledowski, C., Kaiser, J., 2021. Decoding Concurrent Representations of Pitch and Location in Auditory Working Memory. *J. Neurosci.* 41, 4658–4666. <https://doi.org/10.1523/JNEUROSCI.2999-20.2021>
- Dale, A.M., Fischl, B., Sereno, M.I., 1999. Cortical Surface-Based Analysis: I. Segmentation and Surface Reconstruction. *NeuroImage* 9, 179–194. <https://doi.org/10.1006/nimg.1998.0395>
- Damoiseaux, J.S., Smith, S.M., Witter, M.P., Sanz-Arigita, E.J., Barkhof, F., Scheltens, P., Stam, C.J., Zarei, M., Rombouts, S.A.R.B., 2009. White matter tract integrity in aging and Alzheimer’s disease. *Human Brain Mapping* 30, 1051–1059. <https://doi.org/10.1002/hbm.20563>
- Darwin, C.J., Hukin, R.W., 2000. Effectiveness of spatial cues, prosody, and talker characteristics in selective attention. *J. Acoust. Soc. Am.* 107, 970–977. <https://doi.org/10.1121/1.428278>
- Davis, T., Xue, G., Love, B.C., Preston, A.R., Poldrack, R.A., 2014. Global Neural Pattern Similarity as a Common Basis for Categorization and Recognition Memory. *J. Neurosci.* 34, 7472–7484. <https://doi.org/10.1523/JNEUROSCI.3376-13.2014>
- Dawes, P., Emsley, R., Cruickshanks, K.J., Moore, D.R., Fortnum, H., Edmondson-Jones, M., McCormack, A., Munro, K.J., 2015. Hearing Loss and Cognition: The Role of Hearing Aids, Social Isolation and Depression. *PLOS ONE* 10, e0119616. <https://doi.org/10.1371/journal.pone.0119616>
- De Sousa, K.C., Swanepoel, D.W., Moore, D.R., Myburgh, H.C., Smits, C., 2020. Improving Sensitivity of the Digits-In-Noise Test Using Antiphase Stimuli. *Ear and Hearing* 41, 442–450. <https://doi.org/10.1097/AUD.0000000000000775>
- Deal, J.A., Betz, J., Yaffe, K., Harris, T., Purchase-Helzner, E., Satterfield, S., Pratt, S., Govil, N., Simonsick, E.M., Lin, F.R., for the Health ABC Study Group, 2017. Hearing Impairment and Incident Dementia and Cognitive Decline in Older Adults: The Health ABC Study. *The Journals of Gerontology: Series A* 72, 703–709. <https://doi.org/10.1093/gerona/glw069>
- den Heijer, T., van der Lijn, F., Koudstaal, P.J., Hofman, A., van der Lugt, A., Krestin, G.P., Niessen, W.J., Breteler, M.M.B., 2010. A 10-year follow-up of hippocampal volume on magnetic resonance imaging in early dementia and cognitive decline. *Brain* 133, 1163–1172. <https://doi.org/10.1093/brain/awq048>
- D’Esposito, M., Postle, B.R., 2015. The Cognitive Neuroscience of Working Memory. *Annual Review of Psychology* 66, 115–142. <https://doi.org/10.1146/annurev-psych-010814-015031>
- Dhanjal, N.S., Warren, J.E., Patel, M.C., Wise, R.J.S., 2013. Auditory cortical function during verbal episodic memory encoding in Alzheimer’s disease. *Annals of Neurology* 73, 294–302. <https://doi.org/10.1002/ana.23789>
- Dickerson, B.C., Bakkour, A., Salat, D.H., Feczko, E., Pacheco, J., Greve, D.N., Grodstein, F., Wright, C.I., Blacker, D., Rosas, H.D., Sperling, R.A., Atri, A., Growdon, J.H., Hyman,

- B.T., Morris, J.C., Fischl, B., Buckner, R.L., 2009. The cortical signature of Alzheimer's disease: regionally specific cortical thinning relates to symptom severity in very mild to mild AD dementia and is detectable in asymptomatic amyloid-positive individuals. *Cereb Cortex* 19, 497–510. <https://doi.org/10.1093/cercor/bhn113>
- Dickerson, B.C., Brickhouse, M., McGinnis, S., Wolk, D.A., 2017. Alzheimer's disease: The influence of age on clinical heterogeneity through the human brain connectome. *Alzheimer's & Dementia: Diagnosis, Assessment & Disease Monitoring* 6, 122–135. <https://doi.org/10.1016/j.dadm.2016.12.007>
- Dickerson, B.C., Goncharova, I., Sullivan, M.P., Forchetti, C., Wilson, R.S., Bennett, D.A., Beckett, L.A., de Toledo-Morrell, L., 2001. MRI-derived entorhinal and hippocampal atrophy in incipient and very mild Alzheimer's disease. *Neurobiol Aging* 22, 747–754. [https://doi.org/10.1016/s0197-4580\(01\)00271-8](https://doi.org/10.1016/s0197-4580(01)00271-8)
- Dimsdale-Zucker, H.R., Ritchey, M., Ekstrom, A.D., Yonelinas, A.P., Ranganath, C., 2018. CA1 and CA3 differentially support spontaneous retrieval of episodic contexts within human hippocampal subfields. *Nat Commun* 9, 294. <https://doi.org/10.1038/s41467-017-02752-1>
- Doelling, K.B., Arnal, L.H., Ghitza, O., Poeppel, D., 2014. Acoustic landmarks drive delta-theta oscillations to enable speech comprehension by facilitating perceptual parsing. *Neuroimage* 85 Pt 2, 761–768. <https://doi.org/10.1016/j.neuroimage.2013.06.035>
- Douaud, G., Jbabdi, S., Behrens, T.E.J., Menke, R.A., Gass, A., Monsch, A.U., Rao, A., Whitcher, B., Kindlmann, G., Matthews, P.M., Smith, S., 2011. DTI measures in crossing-fibre areas: Increased diffusion anisotropy reveals early white matter alteration in MCI and mild Alzheimer's disease. *NeuroImage* 55, 880–890. <https://doi.org/10.1016/j.neuroimage.2010.12.008>
- Douaud, G., Menke, R.A.L., Gass, A., Monsch, A.U., Rao, A., Whitcher, B., Zamboni, G., Matthews, P.M., Sollberger, M., Smith, S., 2013. Brain microstructure reveals early abnormalities more than two years prior to clinical progression from mild cognitive impairment to Alzheimer's disease. *J Neurosci* 33, 2147–2155. <https://doi.org/10.1523/JNEUROSCI.4437-12.2013>
- Eastwood, M., Corbin-Rifat, S., 1989. Is the Hearing-Impairment/Dementia Relationship Impaired? *Journal of the American Geriatrics Society* 37, 489–490. <https://doi.org/10.1111/j.1532-5415.1989.tb02661.x>
- Eckert, M.A., Vaden, K.I., Dubno, J.R., 2019. Age-Related Hearing Loss Associations With Changes in Brain Morphology. *Trends Hear* 23, 2331216519857267. <https://doi.org/10.1177/2331216519857267>
- Ekstrom, A., 2010. How and when the fMRI BOLD signal relates to underlying neural activity: the danger in dissociation. *Brain Res Rev* 62, 233–244. <https://doi.org/10.1016/j.brainresrev.2009.12.004>
- Ericsson, K.A., Kintsch, W., 1995. Long-term working memory. *Psychol Rev* 102, 211–245. <https://doi.org/10.1037/0033-295x.102.2.211>
- Esiri, M.M., Pearson, R.C.A., Powell, T.P.S., 1986. The cortex of the primary auditory area in Alzheimer's disease. *Brain Research* 366, 385–387. [https://doi.org/10.1016/0006-8993\(86\)91324-7](https://doi.org/10.1016/0006-8993(86)91324-7)
- Esteban, O., Markiewicz, C.J., Blair, R.W., Moodie, C.A., Isik, A.I., Erramuzpe, A., Kent, J.D., Goncalves, M., DuPre, E., Snyder, M., Oya, H., Ghosh, S.S., Wright, J., Durnez, J., Poldrack, R.A., Gorgolewski, K.J., 2019. fMRIPrep: a robust preprocessing pipeline for functional MRI. *Nat Methods* 16, 111–116. <https://doi.org/10.1038/s41592-018-0235-4>
- Fischl, B., Salat, D.H., Busa, E., Albert, M., Dieterich, M., Haselgrove, C., van der Kouwe, A., Killiany, R., Kennedy, D., Klaveness, S., Montillo, A., Makris, N., Rosen, B., Dale, A.M., 2002. Whole Brain Segmentation: Automated Labeling of Neuroanatomical Structures in the Human Brain. *Neuron* 33, 341–355. [https://doi.org/10.1016/S0896-6273\(02\)00569-X](https://doi.org/10.1016/S0896-6273(02)00569-X)

- Fischl, B., van der Kouwe, A., Destrieux, C., Halgren, E., Ségonne, F., Salat, D.H., Busa, E., Seidman, L.J., Goldstein, J., Kennedy, D., Caviness, V., Makris, N., Rosen, B., Dale, A.M., 2004. Automatically parcellating the human cerebral cortex. *Cereb Cortex* 14, 11–22. <https://doi.org/10.1093/cercor/bhg087>
- Fitzhugh, M.C., Pa, J., 2022. Longitudinal Changes in Resting-State Functional Connectivity and Gray Matter Volume Are Associated with Conversion to Hearing Impairment in Older Adults. *Journal of Alzheimer's Disease* 86, 905–918. <https://doi.org/10.3233/JAD-215288>
- Fleming, S.M., Lau, H.C., 2014. How to measure metacognition. *Front Hum Neurosci* 8, 443. <https://doi.org/10.3389/fnhum.2014.00443>
- Fonov, V., Evans, A., McKinstry, R., Almlí, C., Collins, D., 2009. Unbiased nonlinear average age-appropriate brain templates from birth to adulthood. *NeuroImage, Organization for Human Brain Mapping 2009 Annual Meeting* 47, S102. [https://doi.org/10.1016/S1053-8119\(09\)70884-5](https://doi.org/10.1016/S1053-8119(09)70884-5)
- Friederici, A.D., 2011. The Brain Basis of Language Processing: From Structure to Function. *Physiological Reviews* 91, 1357–1392. <https://doi.org/10.1152/physrev.00006.2011>
- Frisoni, G.B., Altomare, D., Thal, D.R., Ribaldi, F., van der Kant, R., Ossenkoppele, R., Blennow, K., Cummings, J., van Duijn, C., Nilsson, P.M., Dietrich, P.-Y., Scheltens, P., Dubois, B., 2022. The probabilistic model of Alzheimer disease: the amyloid hypothesis revised. *Nat Rev Neurosci* 23, 53–66. <https://doi.org/10.1038/s41583-021-00533-w>
- Füllgrabe, C., Rosen, S., 2016. On The (Un)importance of Working Memory in Speech-in-Noise Processing for Listeners with Normal Hearing Thresholds. *Front Psychol* 7, 1268. <https://doi.org/10.3389/fpsyg.2016.01268>
- Gates, G.A., Anderson, M.L., Feeney, M.P., McCurry, S.M., Larson, E.B., 2008. Central Auditory Dysfunction in Older Persons With Memory Impairment or Alzheimer Dementia. *Archives of Otolaryngology–Head & Neck Surgery* 134, 771–777. <https://doi.org/10.1001/archotol.134.7.771>
- Gates, G.A., Beiser, A., Rees, T.S., D'Agostino, R.B., Wolf, P.A., 2002. Central Auditory Dysfunction May Precede the Onset of Clinical Dementia in People with Probable Alzheimer's Disease. *Journal of the American Geriatrics Society* 50, 482–488. <https://doi.org/10.1046/j.1532-5415.2002.50114.x>
- Gates, G.A., Mills, J.H., 2005. Presbycusis. *The Lancet* 366, 1111–1120. [https://doi.org/10.1016/S0140-6736\(05\)67423-5](https://doi.org/10.1016/S0140-6736(05)67423-5)
- Gertje, E.C., Janelidze, S., Westen, D. van, Cullen, N., Stomrud, E., Palmqvist, S., Hansson, O., Mattsson-Carlsson, N., 2023. Associations Between CSF Markers of Inflammation, White Matter Lesions, and Cognitive Decline in Individuals Without Dementia. *Neurology* 100, e1812–e1824. <https://doi.org/10.1212/WNL.0000000000207113>
- Giraldo, D.L., Smith, R.E., Struyfs, H., Niemantsverdriet, E., De Roeck, E., Bjerke, M., Engelborghs, S., Romero, E., Sijbers, J., Jeurissen, B., 2022. Investigating Tissue-Specific Abnormalities in Alzheimer's Disease with Multi-Shell Diffusion MRI. *J Alzheimers Dis* 90, 1771–1791. <https://doi.org/10.3233/JAD-220551>
- Golden, H.L., Nicholas, J.M., Yong, K.X.X., Downey, L.E., Schott, J.M., Mummery, C.J., Crutch, S.J., Warren, J.D., 2015. Auditory spatial processing in Alzheimer's disease. *Brain* 138, 189–202. <https://doi.org/10.1093/brain/awu337>
- Goll, J.C., Kim, L.G., Ridgway, G.R., Hailstone, J.C., Lehmann, M., Buckley, A.H., Crutch, S.J., Warren, J.D., 2012. Impairments of auditory scene analysis in Alzheimer's disease. *Brain* 135, 190–200. <https://doi.org/10.1093/brain/awr260>
- Gómez-Isla, T., Hollister, R., West, H., Mui, S., Growdon, J.H., Petersen, R.C., Parisi, J.E., Hyman, B.T., 1997. Neuronal loss correlates with but exceeds neurofibrillary tangles in Alzheimer's disease. *Ann Neurol* 41, 17–24. <https://doi.org/10.1002/ana.410410106>
- Gopinath, B., Schneider, J., Hickson, L., McMahon, C.M., Burlutsky, G., Leeder, S.R., Mitchell, P., 2012. Hearing handicap, rather than measured hearing impairment, predicts poorer

- quality of life over 10 years in older adults. *Maturitas* 72, 146–151.
<https://doi.org/10.1016/j.maturitas.2012.03.010>
- Gorgolewski, K., Burns, C., Madison, C., Clark, D., Halchenko, Y., Waskom, M., Ghosh, S., 2011. Nipype: A Flexible, Lightweight and Extensible Neuroimaging Data Processing Framework in Python. *Frontiers in Neuroinformatics* 5, 13.
<https://doi.org/10.3389/fninf.2011.00013>
- Goswami, U., 2019. Speech rhythm and language acquisition: an amplitude modulation phase hierarchy perspective. *Annals of the New York Academy of Sciences* 1453, 67–78.
<https://doi.org/10.1111/nyas.14137>
- Grady, C., 2012. The cognitive neuroscience of ageing. *Nat Rev Neurosci* 13, 491–505.
<https://doi.org/10.1038/nrn3256>
- Griffiths, T.D., Lad, M., Kumar, S., Holmes, E., McMurray, B., Maguire, E.A., Billig, A.J., Sedley, W., 2020. How Can Hearing Loss Cause Dementia? *Neuron* 108, 401–412.
<https://doi.org/10.1016/j.neuron.2020.08.003>
- Griffiths, T.D., Warren, J.D., 2004. What is an auditory object? *Nat. Rev. Neurosci.* 5, 887–892.
<https://doi.org/10.1038/nrn1538>
- Grober, E., Lipton, R.B., Hall, C., Crystal, H., 2000. Memory impairment on free and cued selective reminding predicts dementia. *Neurology* 54, 827–832.
<https://doi.org/10.1212/wnl.54.4.827>
- Gultekin, S.H., Rosenfeld, M.R., Voltz, R., Eichen, J., Posner, J.B., Dalmau, J., 2000. Paraneoplastic limbic encephalitis: neurological symptoms, immunological findings and tumour association in 50 patients. *Brain* 123 (Pt 7), 1481–1494.
<https://doi.org/10.1093/brain/123.7.1481>
- Gurgel, R.K., Ward, P.D., Schwartz, S., Norton, M.C., Foster, N.L., Tschanz, J.T., 2014. Relationship of Hearing loss and Dementia: a Prospective, Population-based Study. *Otol Neurotol* 35, 775–781. <https://doi.org/10.1097/MAO.0000000000000313>
- Hamilton, C.A., Matthews, F.E., Erskine, D., Attems, J., Thomas, A.J., 2021. Neurodegenerative brain changes are associated with area deprivation in the United Kingdom: findings from the Brains for Dementia Research study. *Acta Neuropathol Commun* 9, 198.
<https://doi.org/10.1186/s40478-021-01301-8>
- Hannula, S., Bloigu, R., Majamaa, K., Sorri, M., Mäki-Torkko, E., 2011. Self-Reported Hearing Problems among Older Adults: Prevalence and Comparison to Measured Hearing Impairment. *J Am Acad Audiol* 22, 550–559. <https://doi.org/10.3766/jaaa.22.8.7>
- Harris, K.C., Dubno, J.R., 2017. Age-related deficits in auditory temporal processing: Unique contributions of neural dyssynchrony and slowed neuronal processing. *Neurobiol Aging* 53, 150–158. <https://doi.org/10.1016/j.neurobiolaging.2017.01.008>
- Heinen, R., Bierbrauer, A., Wolf, O.T., Axmacher, N., 2023. Representational formats of human memory traces. *Brain Struct Funct*. <https://doi.org/10.1007/s00429-023-02636-9>
- Herholz, K., 2022. Imaging Clinical Subtypes and Associated Brain Networks in Alzheimer's Disease. *Brain Sci* 12, 146. <https://doi.org/10.3390/brainsci12020146>
- Holmes, E., Griffiths, T.D., 2019. 'Normal' hearing thresholds and fundamental auditory grouping processes predict difficulties with speech-in-noise perception. *Sci Rep* 9, 1–11.
<https://doi.org/10.1038/s41598-019-53353-5>
- Hooft, J.J. van 't, Pelkmans, W., Tomassen, J., Smits, C., Legdeur, N., Braber, A. den, Barkhof, F., Berckel, B. van, Yaqub, M., Scheltens, P., Pijnenburg, Y.A., Visser, P.J., Tijms, B.M., 2023. Distinct disease mechanisms may underlie cognitive decline related to hearing loss in different age groups. *J Neurol Neurosurg Psychiatry* 94, 314–320.
<https://doi.org/10.1136/jnnp-2022-329726>
- Hsieh, S., Schubert, S., Hoon, C., Mioshi, E., Hodges, J.R., 2013. Validation of the Addenbrooke's Cognitive Examination III in Frontotemporal Dementia and Alzheimer's Disease. *DEM* 36, 242–250. <https://doi.org/10.1159/000351671>

- Husain, F.T., Carpenter-Thompson, J.R., Schmidt, S.A., 2014. The effect of mild-to-moderate hearing loss on auditory and emotion processing networks. *Front Syst Neurosci* 8, 10. <https://doi.org/10.3389/fnsys.2014.00010>
- Idrizbegovic, E., Canlon, B., Bross, L.S., Willott, J.F., Bogdanovic, N., 2001. The total number of neurons and calcium binding protein positive neurons during aging in the cochlear nucleus of CBA/CaJ mice: a quantitative study. *Hearing Research* 158, 102–115. [https://doi.org/10.1016/S0378-5955\(01\)00295-7](https://doi.org/10.1016/S0378-5955(01)00295-7)
- Idrizbegovic, E., Hederstierna, C., Dahlquist, M., Kämpfe Nordström, C., Jelic, V., Rosenhall, U., 2011. Central auditory function in early Alzheimer's disease and in mild cognitive impairment. *Age and Ageing* 40, 249–254. <https://doi.org/10.1093/ageing/afq168>
- Jack, C.R., Barkhof, F., Bernstein, M.A., Cantillon, M., Cole, P.E., DeCarli, C., Dubois, B., Duchesne, S., Fox, N.C., Frisoni, G.B., Hampel, H., Hill, D.L., Johnson, K., Mangin, J.-F., Scheltens, P., Schwarz, A.J., Sperling, R., Suhy, J., Thompson, P.M., Weiner, M., Foster, N.L., 2011. Steps to standardization and validation of hippocampal volumetry as a biomarker in clinical trials and diagnostic criteria for Alzheimer's disease. *Alzheimers Dement* 7, 474–485.e4. <https://doi.org/10.1016/j.jalz.2011.04.007>
- Jack, C.R., Bennett, D.A., Blennow, K., Carrillo, M.C., Dunn, B., Haeberlein, S.B., Holtzman, D.M., Jagust, W., Jessen, F., Karlawish, J., Liu, E., Molinuevo, J.L., Montine, T., Phelps, C., Rankin, K.P., Rowe, C.C., Scheltens, P., Siemers, E., Snyder, H.M., Sperling, R., Elliott, C., Masliah, E., Ryan, L., Silverberg, N., 2018. NIA-AA Research Framework: Toward a biological definition of Alzheimer's disease. *Alzheimer's & Dementia* 14, 535–562. <https://doi.org/10.1016/j.jalz.2018.02.018>
- Jack, C.R., Petersen, R.C., Xu, Y.C., O'Brien, P.C., Smith, G.E., Ivnik, R.J., Boeve, B.F., Waring, S.C., Tangalos, E.G., Kokmen, E., 1999. Prediction of AD with MRI-based hippocampal volume in mild cognitive impairment. *Neurology* 52, 1397–1403. <https://doi.org/10.1212/wnl.52.7.1397>
- Janelidze, S., Bali, D., Ashton, N.J., Barthélemy, N.R., Vanbrabant, J., Stoops, E., Vanmechelen, E., He, Y., Dolado, A.O., Triana-Baltzer, G., Pontecorvo, M.J., Zetterberg, H., Kolb, H., Vandijck, M., Blennow, K., Bateman, R.J., Hansson, O., 2023. Head-to-head comparison of 10 plasma phospho-tau assays in prodromal Alzheimer's disease. *Brain* 146, 1592–1601. <https://doi.org/10.1093/brain/awac333>
- Jang, S.H., Choi, E.B., 2022. Evaluation of Structural Neural Connectivity Between the Primary Auditory Cortex and Cognition-Related Brain Areas Using Diffusion Tensor Tractography in 43 Normal Adults. *Med Sci Monit* 28. <https://doi.org/10.12659/MSM.936131>
- Jayakody, D.M.P., Friedland, P.L., Eikelboom, R.H., Martins, R.N., Sohrabi, H.R., 2018. A novel study on association between untreated hearing loss and cognitive functions of older adults: Baseline non-verbal cognitive assessment results. *Clin Otolaryngol* 43, 182–191. <https://doi.org/10.1111/coa.12937>
- Jessen, F., Wolfsgruber, S., Wiese, B., Bickel, H., Mösch, E., Kaduszkiewicz, H., Pentzek, M., Riedel-Heller, S.G., Luck, T., Fuchs, A., Weyerer, S., Werle, J., van den Bussche, H., Scherer, M., Maier, W., Wagner, M., German Study on Aging, Cognition and Dementia in Primary Care Patients, 2014. AD dementia risk in late MCI, in early MCI, and in subjective memory impairment. *Alzheimer's & Dementia* 10, 76–83. <https://doi.org/10.1016/j.jalz.2012.09.017>
- Jiang, J., Johnson, J.C.S., Requena-Komuro, M.-C., Benhamou, E., Sivasathiseelan, H., Chokesuwattanaskul, A., Nelson, A., Nortley, R., Weil, R.S., Volkmer, A., Marshall, C.R., Bamiou, D.-E., Warren, J.D., Hardy, C.J.D., 2023. Comprehension of acoustically degraded speech in Alzheimer's disease and primary progressive aphasia. *Brain* awad163. <https://doi.org/10.1093/brain/awad163>
- Johnson, J.C.S., Marshall, C.R., Weil, R.S., Bamiou, D.-E., Hardy, C.J.D., Warren, J.D., 2021. Hearing and dementia: from ears to brain. *Brain* 144, 391–401.

- <https://doi.org/10.1093/brain/awaa429>
- Kahana, M.J., 2006. The Cognitive Correlates of Human Brain Oscillations. *J. Neurosci.* 26, 1669–1672. <https://doi.org/10.1523/JNEUROSCI.3737-05c.2006>
- Kantarci, K., Lesnick, T., Ferman, T.J., Przybelski, S.A., Boeve, B.F., Smith, G.E., Kremers, W.K., Knopman, D.S., Jack, C.R., Petersen, R.C., 2016. Hippocampal volumes predict risk of dementia with Lewy bodies in mild cognitive impairment. *Neurology* 87, 2317–2323. <https://doi.org/10.1212/WNL.0000000000003371>
- Kantarci, K., Petersen, R.C., Boeve, B.F., Knopman, D.S., Weigand, S.D., O'Brien, P.C., Shiung, M.M., Smith, G.E., Ivnik, R.J., Tangalos, E.G., Jack, C.R., 2005. DWI predicts future progression to Alzheimer disease in amnesic mild cognitive impairment. *Neurology* 64, 902–904. <https://doi.org/10.1212/01.WNL.0000153076.46126.E9>
- Karikari, T.K., Ashton, N.J., Brinkmalm, G., Brum, W.S., Benedet, A.L., Montoliu-Gaya, L., Lantero-Rodriguez, J., Pascoal, T.A., Suárez-Calvet, M., Rosa-Neto, P., Blennow, K., Zetterberg, H., 2022. Blood phospho-tau in Alzheimer disease: analysis, interpretation, and clinical utility. *Nat Rev Neurol* 18, 400–418. <https://doi.org/10.1038/s41582-022-00665-2>
- Kiely, K.M., Gopinath, B., Mitchell, P., Browning, C.J., Anstey, K.J., 2012. Evaluating a Dichotomized Measure of Self-Reported Hearing Loss Against Gold Standard Audiometry: Prevalence Estimates and Age Bias in a Pooled National Data set. *J Aging Health* 24, 439–458. <https://doi.org/10.1177/0898264311425088>
- Killion, M.C., Niquette, P.A., Gudmundsen, G.I., Revit, L.J., Banerjee, S., 2004. Development of a quick speech-in-noise test for measuring signal-to-noise ratio loss in normal-hearing and hearing-impaired listeners. *J Acoust Soc Am* 116, 2395–2405. <https://doi.org/10.1121/1.1784440>
- King, A.J., Teki, S., Willmore, B.D.B., 2018. Recent advances in understanding the auditory cortex. *F1000Res* 7, F1000 Faculty Rev-1555. <https://doi.org/10.12688/f1000research.15580.1>
- Klein, A., Ghosh, S.S., Bao, F.S., Giard, J., Häme, Y., Stavsky, E., Lee, N., Rossa, B., Reuter, M., Neto, E.C., Keshavan, A., 2017. Mindboggling morphometry of human brains. *PLOS Computational Biology* 13, e1005350. <https://doi.org/10.1371/journal.pcbi.1005350>
- Kocagoncu, E., Klimovich-Gray, A., Hughes, L.E., Rowe, J.B., 2021. Evidence and implications of abnormal predictive coding in dementia. *Brain* 144, 3311–3321. <https://doi.org/10.1093/brain/awab254>
- Koelsch, S., Schulze, K., Sammler, D., Fritz, T., Müller, K., Gruber, O., 2009. Functional architecture of verbal and tonal working memory: an fMRI study. *Hum Brain Mapp* 30, 859–873. <https://doi.org/10.1002/hbm.20550>
- Kraus, K.S., Canlon, B., 2012. Neuronal connectivity and interactions between the auditory and limbic systems. Effects of noise and tinnitus. *Hearing Research, Annual Reviews* 2012 288, 34–46. <https://doi.org/10.1016/j.heares.2012.02.009>
- Kriegeskorte, N., Mur, M., Bandettini, P., 2008. Representational similarity analysis - connecting the branches of systems neuroscience. *Frontiers in Systems Neuroscience* 2.
- Kullmann, D.M., 2020. Editorial. *Brain* 143, 1045. <https://doi.org/10.1093/brain/awaa082>
- Kumar, S., Bonnici, H.M., Teki, S., Agus, T.R., Pressnitzer, D., Maguire, E.A., Griffiths, T.D., 2014. Representations of specific acoustic patterns in the auditory cortex and hippocampus. *Proc. Biol. Sci.* 281, 20141000. <https://doi.org/10.1098/rspb.2014.1000>
- Kumar, S., Gander, P.E., Berger, J.I., Billig, A.J., Nourski, K.V., Oya, H., Kawasaki, H., Howard, M.A., Griffiths, T.D., 2021. Oscillatory correlates of auditory working memory examined with human electrocorticography. *Neuropsychologia* 150, 107691. <https://doi.org/10.1016/j.neuropsychologia.2020.107691>
- Kumar, S., Joseph, S., Gander, P.E., Barascud, N., Halpern, A.R., Griffiths, T.D., 2016. A Brain System for Auditory Working Memory. *J. Neurosci.* 36, 4492–4505.

- <https://doi.org/10.1523/JNEUROSCI.4341-14.2016>
- Kwan, A.T.H., Arfaie, S., Therriault, J., Azizi, Z., Lussier, F.Z., Tissot, C., Chamoun, M., Bezgin, G., Servaes, S., Stevenon, J., Rahmouni, N., Pallen, V., Gauthier, S., Rosa-Neto, P., 2023. Medial temporal tau predicts memory decline in cognitively unimpaired elderly. *Brain Commun* 5, fcac325. <https://doi.org/10.1093/braincomms/fcac325>
- Lad, M., Billig, A.J., Kumar, S., Griffiths, T.D., 2021. A specific relationship between musical sophistication and auditory working memory. <https://doi.org/10.1101/2021.07.08.451659>
- Lad, M., Holmes, E., Chu, A., Griffiths, T.D., 2020. Speech-in-noise detection is related to auditory working memory precision for frequency. *Sci Rep* 10, 13997. <https://doi.org/10.1038/s41598-020-70952-9>
- Lad, M., Sedley, W., Griffiths, T.D., 2022. Sensory Loss and Risk of Dementia. *Neuroscientist* 10738584221126090. <https://doi.org/10.1177/10738584221126090>
- Leong, V., Stone, M.A., Turner, R.E., Goswami, U., 2014. A role for amplitude modulation phase relationships in speech rhythm perception. *J Acoust Soc Am* 136, 366–381. <https://doi.org/10.1121/1.4883366>
- Levin, F., Ferreira, D., Lange, C., Dyrba, M., Westman, E., Buchert, R., Teipel, S.J., Grothe, M.J., for the Alzheimer’s Disease Neuroimaging Initiative, 2021. Data-driven FDG-PET subtypes of Alzheimer’s disease-related neurodegeneration. *Alzheimer’s Research & Therapy* 13, 49. <https://doi.org/10.1186/s13195-021-00785-9>
- Lewis, D., Campbell, M., Terry, R., Morrison, J., 1987. Laminar and regional distributions of neurofibrillary tangles and neuritic plaques in Alzheimer’s disease: a quantitative study of visual and auditory cortices. *J Neurosci* 7, 1799–1808. <https://doi.org/10.1523/JNEUROSCI.07-06-01799.1987>
- Lieberman, M.C., Kiang, N.Y., 1978. Acoustic trauma in cats. Cochlear pathology and auditory-nerve activity. *Acta Otolaryngol Suppl* 358, 1–63.
- Lin, F.R., Ferrucci, L., An, Y., Goh, J.O., Doshi, J., Metter, E.J., Davatzikos, C., Kraut, M.A., Resnick, S.M., 2014. Association of hearing impairment with brain volume changes in older adults. *Neuroimage* 90, 84–92. <https://doi.org/10.1016/j.neuroimage.2013.12.059>
- Lin, F.R., Metter, E.J., O’Brien, R.J., Resnick, S.M., Zonderman, A.B., Ferrucci, L., 2011a. Hearing Loss and Incident Dementia. *Arch Neurol* 68, 214–220. <https://doi.org/10.1001/archneurol.2010.362>
- Lin, F.R., Thorpe, R., Gordon-Salant, S., Ferrucci, L., 2011b. Hearing Loss Prevalence and Risk Factors Among Older Adults in the United States. *J Gerontol A Biol Sci Med Sci* 66A, 582–590. <https://doi.org/10.1093/gerona/glr002>
- Linden, D.E.J., 2007. The Working Memory Networks of the Human Brain. *Neuroscientist* 13, 257–267. <https://doi.org/10.1177/1073858406298480>
- Linke, A.C., Cusack, R., 2015. Flexible information coding in human auditory cortex during perception, imagery, and STM of complex sounds. *J Cogn Neurosci* 27, 1322–1333. https://doi.org/10.1162/jocn_a_00780
- Linke, A.C., Vicente-Grabovetsky, A., Cusack, R., 2011. Stimulus-specific suppression preserves information in auditory short-term memory. *Proceedings of the National Academy of Sciences* 108, 12961–12966. <https://doi.org/10.1073/pnas.1102118108>
- Livingston, G., Huntley, J., Sommerlad, A., Ames, D., Ballard, C., Banerjee, S., Brayne, C., Burns, A., Cohen-Mansfield, J., Cooper, C., Costafreda, S.G., Dias, A., Fox, N., Gitlin, L.N., Howard, R., Kales, H.C., Kivimäki, M., Larson, E.B., Ogunniyi, A., Orgeta, V., Ritchie, K., Rockwood, K., Sampson, E.L., Samus, Q., Schneider, L.S., Selbæk, G., Teri, L., Mukadam, N., 2020. Dementia prevention, intervention, and care: 2020 report of the Lancet Commission. *Lancet* 396, 413–446. [https://doi.org/10.1016/S0140-6736\(20\)30367-6](https://doi.org/10.1016/S0140-6736(20)30367-6)
- Loughrey, D.G., 2022. Is age-related hearing loss a potentially modifiable risk factor for dementia? *The Lancet Healthy Longevity* 3, e805–e806.

- [https://doi.org/10.1016/S2666-7568\(22\)00252-5](https://doi.org/10.1016/S2666-7568(22)00252-5)
- Loughrey, D.G., Kelly, M.E., Kelley, G.A., Brennan, S., Lawlor, B.A., 2018. Association of Age-Related Hearing Loss With Cognitive Function, Cognitive Impairment, and Dementia: A Systematic Review and Meta-analysis. *JAMA Otolaryngol Head Neck Surg* 144, 115–126. <https://doi.org/10.1001/jamaoto.2017.2513>
- Lowe, V.J., Bruinsma, T.J., Wiste, H.J., Min, H.-K., Weigand, S.D., Fang, P., Senjem, M.L., Therneau, T.M., Boeve, B.F., Josephs, K.A., Pandey, M.K., Murray, M.E., Kantarci, K., Jones, D.T., Vemuri, P., Graff-Radford, J., Schwarz, C.G., Machulda, M.M., Mielke, M.M., Roberts, R.O., Knopman, D.S., Petersen, R.C., Jack, C.R., 2019. Cross-sectional associations of tau-PET signal with cognition in cognitively unimpaired adults. *Neurology* 93, e29–e39. <https://doi.org/10.1212/WNL.00000000000007728>
- Lowndes, G., Savage, G., 2007. Early Detection of Memory Impairment in Alzheimer's Disease: A Neurocognitive Perspective on Assessment. *Neuropsychol Rev* 17, 193–202. <https://doi.org/10.1007/s11065-007-9032-z>
- Ma, W.J., Husain, M., Bays, P.M., 2014. Changing concepts of working memory. *Nat. Neurosci.* 17, 347–356. <https://doi.org/10.1038/nn.3655>
- Maharani, A., Pendleton, N., Leroi, I., 2019. Hearing Impairment, Loneliness, Social Isolation, and Cognitive Function: Longitudinal Analysis Using English Longitudinal Study on Ageing. *The American Journal of Geriatric Psychiatry* 27, 1348–1356. <https://doi.org/10.1016/j.jagp.2019.07.010>
- Marchant, N.L., Reed, B.R., DeCarli, C.S., Madison, C.M., Weiner, M.W., Chui, H.C., Jagust, W.J., 2012. Cerebrovascular disease, beta-amyloid, and cognition in aging. *Neurobiology of Aging* 33, 1006.e25-1006.e36. <https://doi.org/10.1016/j.neurobiolaging.2011.10.001>
- Marek, S., Tervo-Clemmens, B., Calabro, F.J., Montez, D.F., Kay, B.P., Hatoum, A.S., Donohue, M.R., Foran, W., Miller, R.L., Hendrickson, T.J., Malone, S.M., Kandala, S., Feczko, E., Miranda-Dominguez, O., Graham, A.M., Earl, E.A., Perrone, A.J., Cordova, M., Doyle, O., Moore, L.A., Conan, G.M., Uriarte, J., Snider, K., Lynch, B.J., Wilgenbusch, J.C., Pengo, T., Tam, A., Chen, J., Newbold, D.J., Zheng, A., Seider, N.A., Van, A.N., Metoki, A., Chauvin, R.J., Laumann, T.O., Greene, D.J., Petersen, S.E., Garavan, H., Thompson, W.K., Nichols, T.E., Yeo, B.T.T., Barch, D.M., Luna, B., Fair, D.A., Dosenbach, N.U.F., 2022. Reproducible brain-wide association studies require thousands of individuals. *Nature* 603, 654–660. <https://doi.org/10.1038/s41586-022-04492-9>
- Marinelli, J.P., Lohse, C.M., Fussell, W.L., Petersen, R.C., Reed, N.S., Machulda, M.M., Vassilaki, M., Carlson, M.L., 2022. Association between hearing loss and development of dementia using formal behavioural audiometric testing within the Mayo Clinic Study of Aging (MCSA): a prospective population-based study. *The Lancet Healthy Longevity* 3, e817–e824. [https://doi.org/10.1016/S2666-7568\(22\)00241-0](https://doi.org/10.1016/S2666-7568(22)00241-0)
- Mayes, A.R., Montaldi, D., Roper, A., Migo, E.M., Gholipour, T., Kafkas, A., 2019. Amount, not strength of recollection, drives hippocampal activity: A problem for apparent word familiarity-related hippocampal activation. *Hippocampus* 29, 46–59. <https://doi.org/10.1002/hipo.23031>
- McKhann, G.M., Knopman, D.S., Chertkow, H., Hyman, B.T., Jack, C.R., Kawas, C.H., Klunk, W.E., Koroshetz, W.J., Manly, J.J., Mayeux, R., Mohs, R.C., Morris, J.C., Rossor, M.N., Scheltens, P., Carrillo, M.C., Thies, B., Weintraub, S., Phelps, C.H., 2011. The diagnosis of dementia due to Alzheimer's disease: recommendations from the National Institute on Aging-Alzheimer's Association workgroups on diagnostic guidelines for Alzheimer's disease. *Alzheimers Dement* 7, 263–269. <https://doi.org/10.1016/j.jalz.2011.03.005>
- Mick, P., Kawachi, I., Lin, F.R., 2014. The association between hearing loss and social isolation in older adults. *Otolaryngol Head Neck Surg* 150, 378–384.

- <https://doi.org/10.1177/0194599813518021>
- Mielke, M.M., Aakre, J.A., Algeciras-Schimmich, A., Proctor, N.K., Machulda, M.M., Eichenlaub, U., Knopman, D.S., Vemuri, P., Graff-Radford, J., Jack, C.R., Petersen, R.C., Dage, J.L., 2022. Comparison of CSF phosphorylated tau 181 and 217 for cognitive decline. *Alzheimers Dement* 18, 602–611. <https://doi.org/10.1002/alz.12415>
- Miller, T.D., Chong, T.T.-J., Aimola Davies, A.M., Johnson, M.R., Irani, S.R., Husain, M., Ng, T.W., Jacob, S., Maddison, P., Kennard, C., Gowland, P.A., Rosenthal, C.R., 2020. Human hippocampal CA3 damage disrupts both recent and remote episodic memories. *Elife* 9, e41836. <https://doi.org/10.7554/eLife.41836>
- Miller, T.D., Chong, T.T.-J., Aimola Davies, A.M., Ng, T.W.C., Johnson, M.R., Irani, S.R., Vincent, A., Husain, M., Jacob, S., Maddison, P., Kennard, C., Gowland, P.A., Rosenthal, C.R., 2017. Focal CA3 hippocampal subfield atrophy following LGI1 VGKC-complex antibody limbic encephalitis. *Brain* 140, 1212–1219. <https://doi.org/10.1093/brain/awx070>
- Mohammed, A., Gibbons, L.E., Gates, G., Anderson, M.L., McCurry, S.M., McCormick, W., Bowen, J.D., Grabowski, T.J., Crane, P.K., Larson, E.B., 2022. Association of Performance on Dichotic Auditory Tests With Risk for Incident Dementia and Alzheimer Dementia. *JAMA Otolaryngol Head Neck Surg* 148, 20–27. <https://doi.org/10.1001/jamaoto.2021.2716>
- Möller, C., Vrenken, H., Jiskoot, L., Versteeg, A., Barkhof, F., Scheltens, P., van der Flier, W.M., 2013. Different patterns of gray matter atrophy in early- and late-onset Alzheimer's disease. *Neurobiology of Aging* 34, 2014–2022. <https://doi.org/10.1016/j.neurobiolaging.2013.02.013>
- Moore, D.R., Edmondson-Jones, M., Dawes, P., Fortnum, H., McCormack, A., Pierzycki, R.H., Munro, K.J., 2014. Relation between Speech-in-Noise Threshold, Hearing Loss and Cognition from 40–69 Years of Age. *PLOS ONE* 9, e107720. <https://doi.org/10.1371/journal.pone.0107720>
- Motlagh Zadeh, L., Silbert, N.H., Sternasty, K., Swanepoel, D.W., Hunter, L.L., Moore, D.R., 2019. Extended high-frequency hearing enhances speech perception in noise. *Proc. Natl. Acad. Sci. U.S.A.* 116, 23753–23759. <https://doi.org/10.1073/pnas.1903315116>
- Müllensiefen, D., Gingras, B., Musil, J., Stewart, L., 2014. The Musicality of Non-Musicians: An Index for Assessing Musical Sophistication in the General Population. *PLOS ONE* 9, e89642. <https://doi.org/10.1371/journal.pone.0089642>
- Müller, M.J., Greverus, D., Dellani, P.R., Weibrich, C., Wille, P.R., Scheurich, A., Stoeter, P., Fellgiebel, A., 2005. Functional implications of hippocampal volume and diffusivity in mild cognitive impairment. *Neuroimage* 28, 1033–1042. <https://doi.org/10.1016/j.neuroimage.2005.06.029>
- Mumford, J.A., Turner, B.O., Ashby, F.G., Poldrack, R.A., 2012. Deconvolving BOLD activation in event-related designs for multivoxel pattern classification analyses. *Neuroimage* 59, 2636–2643. <https://doi.org/10.1016/j.neuroimage.2011.08.076>
- Munoz-Lopez, M., MohedanoMorianio, A., Insausti, R., 2010. Anatomical Pathways for Auditory Memory in Primates. *Frontiers in Neuroanatomy* 4.
- Nakaya, M., Sato, N., Matsuda, H., Maikusa, N., Shigemoto, Y., Sone, D., Yamao, T., Ogawa, M., Kimura, Y., Chiba, E., Ohnishi, M., Kato, K., Okita, K., Tsukamoto, T., Yokoi, Y., Sakata, M., Abe, O., 2022. Free water derived by multi-shell diffusion MRI reflects tau/neuroinflammatory pathology in Alzheimer's disease. *Alzheimers Dement (N Y)* 8, e12356. <https://doi.org/10.1002/trc2.12356>
- Neff, R.M., Jicha, G., Westgate, P.M., Hawk, G.S., Bush, M.L., McNulty, B., 2019. Neuropathological Findings of Dementia Associated With Subjective Hearing Loss. *Otol Neurotol* 40, e883–e893. <https://doi.org/10.1097/MAO.0000000000002381>
- Nondahl, D.M., Cruickshanks, K.J., Wiley, T.L., Tweed, T.S., Klein, R., Klein, B.E.K., 1998. Accuracy of Self-reported Hearing Loss. *Audiology* 37, 295–301.

- <https://doi.org/10.3109/00206099809072983>
- Nyberg, L., Lövdén, M., Riklund, K., Lindenberger, U., Bäckman, L., 2012. Memory aging and brain maintenance. *Trends in Cognitive Sciences* 16, 292–305.
<https://doi.org/10.1016/j.tics.2012.04.005>
- Olshausen, B.A., Field, D.J., 1996. Emergence of simple-cell receptive field properties by learning a sparse code for natural images. *Nature* 381, 607–609.
<https://doi.org/10.1038/381607a0>
- Paciello, F., Rinaudo, M., Longo, V., Cocco, S., Conforto, G., Pisani, A., Podda, M.V., Fetoni, A.R., Paludetti, G., Grassi, C., 2021. Auditory sensory deprivation induced by noise exposure exacerbates cognitive decline in a mouse model of Alzheimer’s disease. *eLife* 10, e70908. <https://doi.org/10.7554/eLife.70908>
- Paivio, A., Yuille, J.C., Madigan, S.A., 1968. Concreteness, imagery, and meaningfulness values for 925 nouns. *Journal of Experimental Psychology* 76, 1–25.
<https://doi.org/10.1037/h0025327>
- Palmqvist, S., Tideman, P., Cullen, N., Zetterberg, H., Blennow, K., Alzheimer’s Disease Neuroimaging Initiative, Dage, J.L., Stomrud, E., Janelidze, S., Mattsson-Carlsson, N., Hansson, O., 2021. Prediction of future Alzheimer’s disease dementia using plasma phospho-tau combined with other accessible measures. *Nat Med* 27, 1034–1042.
<https://doi.org/10.1038/s41591-021-01348-z>
- Parbery-Clark, A., Skoe, E., Lam, C., Kraus, N., 2009. Musician enhancement for speech-in-noise. *Ear Hear* 30, 653–661.
<https://doi.org/10.1097/AUD.0b013e3181b412e9>
- Parker, T., Cash, D.M., Lane, C., Lu, K., Malone, I.B., Nicholas, J.M., James, S., Keshavan, A., Murray-Smith, H., Wong, A., Buchannan, S., Keuss, S., Sudre, C.H., Thomas, D., Crutch, S., Bamiou, D.-E., Warren, J.D., Fox, N.C., Richards, M., Schott, J.M., 2019. Pure tone audiometry and cerebral pathology in healthy older adults. *J. Neurol. Neurosurg. Psychiatry*. <https://doi.org/10.1136/jnnp-2019-321897>
- Parthasarathy, A., Hancock, K.E., Bennett, K., DeGruttola, V., Polley, D.B., 2020. Bottom-up and top-down neural signatures of disordered multi-talker speech perception in adults with normal hearing. *eLife* 9, e51419. <https://doi.org/10.7554/eLife.51419>
- Parthasarathy, A., Kujawa, S.G., 2018. Synaptopathy in the Aging Cochlea: Characterizing Early-Neural Deficits in Auditory Temporal Envelope Processing. *J Neurosci* 38, 7108–7119. <https://doi.org/10.1523/JNEUROSCI.3240-17.2018>
- Pertzov, Y., Miller, T.D., Gorgoraptis, N., Caine, D., Schott, J.M., Butler, C., Husain, M., 2013. Binding deficits in memory following medial temporal lobe damage in patients with voltage-gated potassium channel complex antibody-associated limbic encephalitis. *Brain* 136, 2474–2485. <https://doi.org/10.1093/brain/awt129>
- Plack, C.J., Barker, D., Prendergast, G., 2014. Perceptual Consequences of “Hidden” Hearing Loss. *Trends in Hearing* 18, 2331216514550621.
<https://doi.org/10.1177/2331216514550621>
- Poldrack, R.A., Huckins, G., Varoquaux, G., 2020. Establishment of Best Practices for Evidence for Prediction: A Review. *JAMA Psychiatry* 77, 534–540.
<https://doi.org/10.1001/jamapsychiatry.2019.3671>
- Poulakis, K., Pereira, J.B., Mecocci, P., Vellas, B., Tsolaki, M., Kłoszewska, I., Soininen, H., Lovestone, S., Simmons, A., Wahlund, L.-O., Westman, E., 2018. Heterogeneous patterns of brain atrophy in Alzheimer’s disease. *Neurobiology of Aging* 65, 98–108.
<https://doi.org/10.1016/j.neurobiolaging.2018.01.009>
- Pronk, M., Deeg, D.J.H., Festen, J.M., Twisk, J.W., Smits, C., Comijs, H.C., Kramer, S.E., 2013. Decline in Older Persons’ Ability to Recognize Speech in Noise: The Influence of Demographic, Health-Related, Environmental, and Cognitive Factors. *Ear and Hearing* 34, 722. <https://doi.org/10.1097/AUD.0b013e3182994eee>

- Pronk, M., Deeg, D.J.H., Smits, C., van Tilburg, T.G., Kuik, D.J., Festen, J.M., Kramer, S.E., 2011. Prospective effects of hearing status on loneliness and depression in older persons: identification of subgroups. *Int J Audiol* 50, 887–896. <https://doi.org/10.3109/14992027.2011.599871>
- Raichle, M.E., Snyder, A.Z., 2007. A default mode of brain function: A brief history of an evolving idea. *NeuroImage* 37, 1083–1090. <https://doi.org/10.1016/j.neuroimage.2007.02.041>
- Rauschecker, J., 2012. Ventral and dorsal streams in the evolution of speech and language. *Frontiers in Evolutionary Neuroscience* 4.
- Rodriguez, A., Klein, C.J., Sechi, E., Alden, E., Basso, M.R., Pudumjee, S., Pittcock, S.J., McKeon, A., Britton, J.W., Lopez-Chiriboga, A.S., Zekeridou, A., Zaleski, N.L., Boeve, B.F., Day, G.S., Gadoth, A., Burkholder, D., Toledano, M., Dubey, D., Flanagan, E.P., 2022. LGI1 antibody encephalitis: acute treatment comparisons and outcome. *J Neurol Neurosurg Psychiatry* 93, 309–315. <https://doi.org/10.1136/jnnp-2021-327302>
- Rubin, E.H., Storandt, M., Miller, J.P., Kinscherf, D.A., Grant, E.A., Morris, J.C., Berg, L., 1998. A Prospective Study of Cognitive Function and Onset of Dementia in Cognitively Healthy Elders. *Archives of Neurology* 55, 395–401. <https://doi.org/10.1001/archneur.55.3.395>
- Schmiedt, R.A., Lang, H., Okamura, H., Schulte, B.A., 2002. Effects of furosemide applied chronically to the round window: a model of metabolic presbycusis. *J Neurosci* 22, 9643–9650. <https://doi.org/10.1523/JNEUROSCI.22-21-09643.2002>
- Schneider, B.A., Pichora-Fuller, M.K., 2001. Age-Related Changes in Temporal Processing: Implications for Speech Perception. *Semin Hear* 22, 227–240. <https://doi.org/10.1055/s-2001-15628>
- Schuknecht, H.F., Gacek, M.R., 1993. Cochlear Pathology in Presbycusis. *Ann Otol Rhinol Laryngol* 102, 1–16. <https://doi.org/10.1177/00034894931020S101>
- Schuknecht, H.F., Watanuki, K., Takahashi, T., Aziz Belal Jr, A., Kimura, R.S., Jones, D.D., Ota, C.Y., 1974. Atrophy of the stria vascularis, a common cause for hearing loss. *The Laryngoscope* 84, 1777–1821. <https://doi.org/10.1288/00005537-197410000-00012>
- Shao, X., Fan, S., Luo, H., Wong, T.Y., Zhang, W., Guan, H., Qiu, A., 2020. Brain Magnetic Resonance Imaging Characteristics of Anti-Leucine-Rich Glioma-Inactivated 1 Encephalitis and Their Clinical Relevance: A Single-Center Study in China. *Front Neurol* 11, 618109. <https://doi.org/10.3389/fneur.2020.618109>
- Shrager, Y., Levy, D.A., Hopkins, R.O., Squire, L.R., 2008. Working Memory and the Organization of Brain Systems. *J Neurosci* 28, 4818–4822. <https://doi.org/10.1523/JNEUROSCI.0710-08.2008>
- Sindhusake, D., Mitchell, P., Smith, W., Golding, M., Newall, P., Hartley, D., Rubin, G., 2001. Validation of self-reported hearing loss. The Blue Mountains Hearing Study. *International Journal of Epidemiology* 30, 1371–1378. <https://doi.org/10.1093/ije/30.6.1371>
- Sinha, U.K., Hollen, K.M., Rodriguez, R., Miller, C.A., 1993. Auditory system degeneration in Alzheimer's disease. *Neurology* 43, 779–785. <https://doi.org/10.1212/wnl.43.4.779>
- Sintini, I., Graff-Radford, J., Senjem, M.L., Schwarz, C.G., Machulda, M.M., Martin, P.R., Jones, D.T., Boeve, B.F., Knopman, D.S., Kantarci, K., Petersen, R.C., Jack, C.R., Jr, Lowe, V.J., Josephs, K.A., Whitwell, J.L., 2020. Longitudinal neuroimaging biomarkers differ across Alzheimer's disease phenotypes. *Brain* 143, 2281–2294. <https://doi.org/10.1093/brain/awaa155>
- Slade, K., Plack, C.J., Nuttall, H.E., 2020. The Effects of Age-Related Hearing Loss on the Brain and Cognitive Function. *Trends in Neurosciences* 43, 810–821. <https://doi.org/10.1016/j.tins.2020.07.005>
- Slade, K., Reilly, J.H., Jablonska, K., Smith, E., Hayes, L.D., Plack, C.J., Nuttall, H.E., 2022. The impact of age-related hearing loss on structural neuroanatomy: A meta-analysis. *Frontiers in Neurology* 13.

- Sohoglu, E., Kumar, S., Chait, M., Griffiths, T.D., 2020. Multivoxel codes for representing and integrating acoustic features in human cortex. *NeuroImage* 217, 116661. <https://doi.org/10.1016/j.neuroimage.2020.116661>
- Souza, P., Arehart, K., 2015. Robust relationship between reading span and speech recognition in noise. *Int J Audiol* 54, 705–713. <https://doi.org/10.3109/14992027.2015.1043062>
- Sr, I., Aw, M., B, L., P, P., P, W., Mr, J., Jm, S., Rj, A., A, S.Z., A, B., Er, S., Sm, S., A, V., 2011. Faciobrachial dystonic seizures precede Lgi1 antibody limbic encephalitis. *Annals of neurology* 69. <https://doi.org/10.1002/ana.22307>
- Stern, Y., Arenaza-Urquijo, E.M., Bartrés-Faz, D., Belleville, S., Cantilon, M., Chetelat, G., Ewers, M., Franzmeier, N., Kempermann, G., Kremen, W.S., Okonkwo, O., Scarmeas, N., Soldan, A., Udeh-Momoh, C., Valenzuela, M., Vemuri, P., Vuoksimaa, E., and the Reserve, Resilience and Protective Factors PIA Empirical Definitions and Conceptual Frameworks Workgroup, 2020. Whitepaper: Defining and investigating cognitive reserve, brain reserve, and brain maintenance. *Alzheimer's & Dementia* 16, 1305–1311. <https://doi.org/10.1016/j.jalz.2018.07.219>
- Stevenson, J.S., Clifton, L., Kuźma, E., Littlejohns, T.J., 2022. Speech-in-noise hearing impairment is associated with an increased risk of incident dementia in 82,039 UK Biobank participants. *Alzheimers Dement* 18, 445–456. <https://doi.org/10.1002/alz.12416>
- Takahashi, S., Yonezawa, H., Takahashi, J., Kudo, M., Inoue, T., Tohgi, H., 2002. Selective reduction of diffusion anisotropy in white matter of Alzheimer disease brains measured by 3.0 Tesla magnetic resonance imaging. *Neurosci Lett* 332, 45–48. [https://doi.org/10.1016/s0304-3940\(02\)00914-x](https://doi.org/10.1016/s0304-3940(02)00914-x)
- Teki, S., Kumar, S., von Kriegstein, K., Stewart, L., Lyness, C.R., Moore, B.C.J., Capleton, B., Griffiths, T.D., 2012. Navigating the auditory scene: an expert role for the hippocampus. *J. Neurosci.* 32, 12251–12257. <https://doi.org/10.1523/JNEUROSCI.0082-12.2012>
- Tierney, M.C., Nores, A., Snow, W.G., Fisher, R.H., Zoritto, M.L., Reid, D.W., 1994. Use of the Rey Auditory Verbal Learning Test in differentiating normal aging from Alzheimer's and Parkinson's dementia. *Psychological Assessment* 6, 129–134. <https://doi.org/10.1037/1040-3590.6.2.129>
- Tsimpida, D., Kontopantelis, E., Ashcroft, D., Panagioti, M., 2020. Comparison of Self-reported Measures of Hearing With an Objective Audiometric Measure in Adults in the English Longitudinal Study of Ageing. *JAMA Network Open* 3, e2015009. <https://doi.org/10.1001/jamanetworkopen.2020.15009>
- Tsimpida, D., Kontopantelis, E., Ashcroft, D., Panagioti, M., 2019. Socioeconomic and lifestyle factors associated with hearing loss in older adults: a cross-sectional study of the English Longitudinal Study of Ageing (ELSA). *BMJ Open* 9, e031030. <https://doi.org/10.1136/bmjopen-2019-031030>
- Turner, J.G., Hughes, L.F., Caspary, D.M., 2005. Affects of aging on receptive fields in rat primary auditory cortex layer V neurons. *J Neurophysiol* 94, 2738–2747. <https://doi.org/10.1152/jn.00362.2005>
- Tustison, N.J., Avants, B.B., Cook, P.A., Zheng, Y., Egan, A., Yushkevich, P.A., Gee, J.C., 2010. N4ITK: improved N3 bias correction. *IEEE Trans Med Imaging* 29, 1310–1320. <https://doi.org/10.1109/TMI.2010.2046908>
- Tuwaig, M., Savard, M., Jutras, B., Poirier, J., Collins, D.L., Rosa-Neto, P., Fontaine, D., Breitner, J.C.S., Group, for the P.-A.R., 2017. Deficit in Central Auditory Processing as a Biomarker of Pre-Clinical Alzheimer's Disease. *Journal of Alzheimer's Disease* 60, 1589–1600. <https://doi.org/10.3233/JAD-170545>
- Utoomprurkporn, N., Hardy, C.J.D., Stott, J., Costafreda, S.G., Warren, J., Bamiou, D.E., 2020. "The Dichotic Digit Test" as an Index Indicator for Hearing Problem in Dementia: Systematic Review and Meta-Analysis. *J Am Acad Audiol* 31, 646–655. <https://doi.org/10.1055/s-0040-1718700>

- Uy, C.E., Binks, S., Irani, S.R., 2021. Autoimmune encephalitis: clinical spectrum and management. *Pract Neurol* 21, 412–423.
<https://doi.org/10.1136/practneurol-2020-002567>
- van Sonderen, A., Schreurs, M.W.J., Wirtz, P.W., Sillevs Smitt, P.A.E., Titulaer, M.J., 2016. From VGKC to LGI1 and Caspr2 encephalitis: The evolution of a disease entity over time. *Autoimmunity Reviews* 15, 970–974. <https://doi.org/10.1016/j.autrev.2016.07.018>
- Walsh, S., Causer, R., Brayne, C., 2021a. Does playing a musical instrument reduce the incidence of cognitive impairment and dementia? A systematic review and meta-analysis. *Aging Ment Health* 25, 593–601.
<https://doi.org/10.1080/13607863.2019.1699019>
- Walsh, S., Luben, R., Hayat, S., Brayne, C., 2021b. Is there a dose-response relationship between musical instrument playing and later-life cognition? A cohort study using EPIC-Norfolk data. *Age Ageing* 50, 220–226. <https://doi.org/10.1093/ageing/afaa242>
- Wang, H.-F., Zhang, W., Rolls, E.T., Li, Y., Wang, L., Ma, Y.-H., Kang, J., Feng, J., Yu, J.-T., Cheng, W., 2022a. Hearing impairment is associated with cognitive decline, brain atrophy and tau pathology. *eBioMedicine* 86.
<https://doi.org/10.1016/j.ebiom.2022.104336>
- Wang, H.-F., Zhang, W., Rolls, E.T., Li, Y., Wang, L., Ma, Y.-H., Kang, J., Feng, J., Yu, J.-T., Cheng, W., 2022b. Hearing impairment is associated with cognitive decline, brain atrophy and tau pathology. *eBioMedicine*, Chengqi Chen 86, 104336.
<https://doi.org/10.1016/j.ebiom.2022.104336>
- Weiner, M.W., Veitch, D.P., Aisen, P.S., Beckett, L.A., Cairns, N.J., Green, R.C., Harvey, D., Jack, C.R., Jagust, W., Morris, J.C., Petersen, R.C., Salazar, J., Saykin, A.J., Shaw, L.M., Toga, A.W., Trojanowski, J.Q., 2017. The Alzheimer’s Disease Neuroimaging Initiative 3: continued innovation for clinical trial improvement. *Alzheimers Dement* 13, 561–571. <https://doi.org/10.1016/j.jalz.2016.10.006>
- Weston, P.S.J., Simpson, I.J.A., Ryan, N.S., Ourselin, S., Fox, N.C., 2015. Diffusion imaging changes in grey matter in Alzheimer’s disease: a potential marker of early neurodegeneration. *Alzheimers Res Ther* 7, 47.
<https://doi.org/10.1186/s13195-015-0132-3>
- Whitwell, J.L., Dickson, D.W., Murray, M.E., Weigand, S.D., Tosakulwong, N., Senjem, M.L., Knopman, D.S., Boeve, B.F., Parisi, J.E., Petersen, R.C., Jack, C.R., Josephs, K.A., 2012. Neuroimaging correlates of pathologically defined subtypes of Alzheimer’s disease: a case-control study. *Lancet Neurol* 11, 868–877.
[https://doi.org/10.1016/S1474-4422\(12\)70200-4](https://doi.org/10.1016/S1474-4422(12)70200-4)
- Whitwell, J.L., Josephs, K.A., Murray, M.E., Kantarci, K., Przybelski, S.A., Weigand, S.D., Vemuri, P., Senjem, M.L., Parisi, J.E., Knopman, D.S., Boeve, B.F., Petersen, R.C., Dickson, D.W., Jack, C.R., 2008. MRI correlates of neurofibrillary tangle pathology at autopsy: a voxel-based morphometry study. *Neurology* 71, 743–749.
<https://doi.org/10.1212/01.wnl.0000324924.91351.7d>
- Willott, J.F., Parham, K., Hunter, K.P., 1988. Response properties of inferior colliculus neurons in young and very old CBA/J mice. *Hear Res* 37, 1–14.
[https://doi.org/10.1016/0378-5955\(88\)90073-1](https://doi.org/10.1016/0378-5955(88)90073-1)
- Wilson, R.H., Carnell, C.S., Cleghorn, A.L., 2007. The Words-in-Noise (WIN) Test with Multitalker Babble and Speech-Spectrum Noise Maskers. *J Am Acad Audiol* 18, 522–529. <https://doi.org/10.3766/jaaa.18.6.7>
- Xia, C., Makaretz, S.J., Caso, C., McGinnis, S., Gomperts, S.N., Sepulcre, J., Gomez-Isla, T., Hyman, B.T., Schultz, A., Vasdev, N., Johnson, K.A., Dickerson, B.C., 2017. Association of In Vivo [18F]AV-1451 Tau PET Imaging Results With Cortical Atrophy and Symptoms in Typical and Atypical Alzheimer Disease. *JAMA Neurology* 74, 427–436.
<https://doi.org/10.1001/jamaneurol.2016.5755>

- Xu, W., Zhang, C., Li, J.-Q., Tan, C.-C., Cao, X.-P., Tan, L., Yu, J.-T., 2019. Age-related hearing loss accelerates cerebrospinal fluid tau levels and brain atrophy: a longitudinal study. *Aging* 11, 3156–3169. <https://doi.org/10.18632/aging.101971>
- Yang, Z., Wen, W., Jiang, J., Crawford, J.D., Reppermund, S., Levitan, C., Slavin, M.J., Kochan, N.A., Richmond, R.L., Brodaty, H., Trollor, J.N., Sachdev, P.S., 2016. Age-associated differences on structural brain MRI in nondemented individuals from 71 to 103 years. *Neurobiology of Aging* 40, 86–97. <https://doi.org/10.1016/j.neurobiolaging.2016.01.006>
- Yeh, F.-C., 2020. Shape analysis of the human association pathways. *NeuroImage* 223, 117329. <https://doi.org/10.1016/j.neuroimage.2020.117329>
- Yeh, F.-C., Badre, D., Verstynen, T., 2016a. Connectometry: A statistical approach harnessing the analytical potential of the local connectome. *Neuroimage* 125, 162–171. <https://doi.org/10.1016/j.neuroimage.2015.10.053>
- Yeh, F.-C., Liu, L., Hitchens, T.K., Wu, Y.L., 2017. Mapping immune cell infiltration using restricted diffusion MRI. *Magnetic Resonance in Medicine* 77, 603–612. <https://doi.org/10.1002/mrm.26143>
- Yeh, F.-C., Panesar, S., Fernandes, D., Meola, A., Yoshino, M., Fernandez-Miranda, J.C., Vettel, J.M., Verstynen, T., 2018. Population-averaged atlas of the macroscale human structural connectome and its network topology. *Neuroimage* 178, 57–68. <https://doi.org/10.1016/j.neuroimage.2018.05.027>
- Yeh, F.-C., Tseng, W.-Y.I., 2011. NTU-90: a high angular resolution brain atlas constructed by q-space diffeomorphic reconstruction. *Neuroimage* 58, 91–99. <https://doi.org/10.1016/j.neuroimage.2011.06.021>
- Yeh, F.-C., Verstynen, T.D., Wang, Y., Fernández-Miranda, J.C., Tseng, W.-Y.I., 2013. Deterministic Diffusion Fiber Tracking Improved by Quantitative Anisotropy. *PLOS ONE* 8, e80713. <https://doi.org/10.1371/journal.pone.0080713>
- Yeh, F.-C., Vettel, J.M., Singh, A., Poczos, B., Grafton, S.T., Erickson, K.I., Tseng, W.-Y.I., Verstynen, T.D., 2016b. Quantifying Differences and Similarities in Whole-Brain White Matter Architecture Using Local Connectome Fingerprints. *PLOS Computational Biology* 12, e1005203. <https://doi.org/10.1371/journal.pcbi.1005203>
- Yeh, F.-C., Wedeen, V.J., Tseng, W.-Y.I., 2010. Generalized q-sampling imaging. *IEEE Trans Med Imaging* 29, 1626–1635. <https://doi.org/10.1109/TMI.2010.2045126>
- Yonelinas, A.P., 2013. The hippocampus supports high-resolution binding in the service of perception, working memory and long-term memory. *Behav. Brain Res.* 254, 34–44. <https://doi.org/10.1016/j.bbr.2013.05.030>
- Zhang, G.-W., Sun, W.-J., Zingg, B., Shen, L., He, J., Xiong, Y., Tao, H.W., Zhang, L.I., 2018. A Non-canonical Reticular-Limbic Central Auditory Pathway via Medial Septum Contributes to Fear Conditioning. *Neuron* 97, 406–417.e4. <https://doi.org/10.1016/j.neuron.2017.12.010>
- Zhang, Y., Brady, M., Smith, S., 2001. Segmentation of brain MR images through a hidden Markov random field model and the expectation-maximization algorithm. *IEEE Trans Med Imaging* 20, 45–57. <https://doi.org/10.1109/42.906424>
- Zokaei, N., Husain, M., 2019. Working Memory in Alzheimer's Disease and Parkinson's Disease. *Curr Top Behav Neurosci* 41, 325–344. https://doi.org/10.1007/7854_2019_103
- Zokaei, N., Nour, M.M., Sillence, A., Drew, D., Adcock, J., Stacey, R., Voets, N., Sen, A., Husain, M., 2019. Binding deficits in visual short-term memory in patients with temporal lobe lobectomy. *Hippocampus* 29, 63–67. <https://doi.org/10.1002/hipo.22998>

Glossary

| | |
|----------------------------|---|
| Aβ | Amyloid Beta |
| AC | Auditory Cortex |
| ACE-III | Addenbrooke's Cognitive Examination (3rd edition) |
| AD | Alzheimer's Disease |
| ADNI | Alzheimer's Disease Neuroimaging Initiative |
| AM | Amplitude Modulation |
| AUC | Area Under the Curve |
| AuM | Auditory Memory |
| BF | Bayes Factor |
| BIC | Bayesian Information Criterion |
| BOLD | Blood Oxygenation Level-Dependent |
| CFI | Comparative Fit Index |
| CPH | Cox Proportional Hazards |
| CSF | Cerebrospinal Fluid |
| dB | Decibels |
| DiN | Digits in Noise |
| DTI | Diffusion Tensor Imaging |
| dMRI | Diffusion Magnetic Resonance Imaging |
| DWI | Diffusion-Weighted Imaging |
| FBDS | Faciobrachial Dystonic Seizures |
| FCD | Functional Cognitive Disorder |
| fMRI | Functional Magnetic Resonance Imaging |
| GLM | General Linear Model |

| | |
|-----------------|--|
| GMSI | Goldsmiths Musical Sophistication Index |
| iEEG | Intracranial Electroencephalography |
| IFG | Inferior Frontal Gyrus |
| INU | Intensity Non-Uniformity |
| IVIG | Intravenous Immunoglobulins |
| HC | Hippocampus |
| Hz | Hertz |
| LGI-1 | Leucine-rich Glioma-inactivated 1 |
| LE | Limbic Encephalitis |
| LTWM | Long-Term Working Memory |
| MCI | Mild Cognitive Impairment |
| MD | Mean Diffusivity |
| MGN | Medial Geniculate Nucleus |
| MMSE | Mini-Mental State Examination |
| MRI | Magnetic Resonance Imaging |
| NIA-AA | National Institute on Ageing and the Alzheimer's Association |
| NFT | Neurofibrillary Tangles |
| PET | Positron Emission Tomography |
| pTau-181 | Phosphorylated Tau 181 |
| PTA | Pure Tone Audiogram |
| QA | Quantitative Anisotropy |
| RAVLT | Rey Auditory Verbal Learning Test |
| RMSEA | Root Mean Square Error of Approximation |
| ROC | Receiver Operator Curve |
| ROI | Region of Interest |
| RSA | Representational Similarity Analysis |

| | |
|-------------|---------------------------------|
| SiB | Speech-in-Babble Task |
| SiN | Speech in Noise |
| SNR | Signal to Noise Ratio |
| TLI | Tucker-Lewis Index |
| VGKC | Voltage-Gated Potassium Channel |